

Volvo Construction Equipment
Building Tomorrow



L110H, L120H

Volvo Wheel Loaders 18-21.6 t / 39,680-47,620 lb 256-272 hp



Progress is in our DNA

Since introducing our first wheel loader, Volvo has continued to refine its concept for more than half a century. Over the years, we have revolutionized our machines, bringing customers unparalleled productivity and efficiency.

1954

The world's first wheel loader to feature a parallel lift arm system and attachment bracket with quick coupler – the H10

1973

The first wheel loader with direct injected turbo engine – Volvo BM 1641

Volvo introduced the world's first truly low-emission diesel engines in construction equipment (1974)

1981

Volvo introduced the world's first automatic gear shifting system (Automatic Power Shift) and load sensing hydraulic technology

1988

Comfort Drive Control

1990

Boom suspension system

Volvo patented Torque Parallel linkage (1991)

SMARTER, STRONGER, FASTER

The new H-series L110 and L120 may boast the same striking design as their forerunners, but these machines have been updated with the latest innovative technology, promoting greater productivity and fuel efficiency. Ready to tackle a range of applications, enjoy the same reliability and quality you'd expect from your Volvo wheel loader and more.



2009

Volvo sets the standard for the attachment bracket (ISO 23727)

2010

OptiShift
CareTrack

2016

Load Assist, powered by the award-winning Volvo Co-Pilot

2017

New generation OptiShift

With you for the long run

As your trusted partner in production, Volvo is here to support you with the best equipment for the job. Boasting a comprehensive portfolio of attachments designed to complement your machines performance, as well as a range of services to boost your profitability, we'll help you tailor the perfect package to suit your business needs.



Smarter operation

Engineered for efficient and smart work, the innovative L110H and L120H wheel loaders combine the latest Volvo technology with power and upgraded features, resulting in 20% greater fuel efficiency than the G-series.

New generation OptiShift

For improved cycle times and greater fuel efficiency, customize the lock-up engagement of your machine, with new generation OptiShift. The improved technology integrates the Reverse By Braking function and the new torque converter with lock-up, creating a direct drive between the engine and transmission.



Reverse By Braking

Extend the life of your machine's components and increase operator comfort with Reverse By Braking (RBB) – patented by Volvo. The braking function slows the machine when the operator wants to change direction, by reducing engine rpm and automatically applying the service brakes, reducing stress on the drivetrain.



Power up, fuel down

Built on decades of experience and featuring the most advanced technology, the powerful Volvo engine delivers high torque at low rpm, for superior performance.



Eco pedal

Save on machine wear and increase fuel efficiency with the eco pedal. Uniquely designed by Volvo, the eco pedal encourages economical operation, by applying a mechanical push-back force in response to excess use of the accelerator.





UP TO 20% GREATER FUEL EFFICIENCY

Do more with less fuel, the H-series machine updates offer up to 20% greater fuel efficiency than the G-series. Contributing to the increase is a more powerful engine, second generation OptiShift, attachment optimization and the new dry P-Brake, which eliminates drag losses.

Made to move

Boosting productivity by up to 5% – in comparison to the G-series – the L110H and L120H are fitted with a new transmission and improved technology. Enhanced by Load Assist and CareTrack, the intelligent systems offer valuable insight about your operations, reducing fuel consumption and cycle times.

Boost your productivity by up to 5%

The H-series machine updates offer up to 5% greater productivity than the G-series. For ultimate stability and high efficiency, the L110H and L120H have been upgraded with a new transmission, which works in harmony with the engine and axels. The new converter delivers increased torque output, resulting in better performance at low speeds. For faster acceleration and smooth operation, the steps between gears have been reduced.



“The machines are productive and very durable, especially when working non-stop in our climate, which is tough during winter months.”
Leszek Kardaszynski, Director of logistics and investment, UNIKOST (Poland)



Comfortably productive

Customize your machine and ensure precise control of hydraulic functions, with the choice of single or multi levers. To get the most out of each operation, select from three hydraulic modes, according to your preferred responsiveness.



Bucket leveling function

Take your productivity to the next level with the new bucket leveling function. Automatically return the bucket to level from both dump and curl positions, enhancing operator performance.



Load Assist

Optimize your load cycles with Load Assist, powered by Volvo Co-Pilot – the revolutionary in-cab display. Gain access to a set of smart apps and boost the efficiency of your operation. The rear-view camera and optional radar detect system are now integrated into the Volvo Co-Pilot display.

On-Board Weighing

When it comes to loading the optimum amount of material, intuition can only get you so far. Are you moving enough material, or moving too much? Say goodbye to guess-work with the On-Board Weighing app. The dynamic load weighing system provides realtime insights into the bucket's load, so you can eliminate overloading, underloading, reweighing and waiting times.



Operator Coaching

Operator Coaching helps to ensure operators are using their Volvo machine to its full potential. The intuitive app provides real-time guidance to operators, helping them understand how their actions influence machine productivity and efficiency, as well as identify areas for improvement or changes in their technique.



Tire Pressure Monitoring System

With the tire pressure monitoring app, you can check the condition of your tires from the comfort of the cab. Providing real-time information on tire pressure and temperature, the system saves time during machine inspections and can prolong tire lifetime.



Map

Get accurate machine positioning with Map, a clever app that allows operators to monitor on-site traffic in real-time. Not only does this give operators an improved orientation of the site they are working on, but it allows them to proactively adjust their driving behavior according to traffic conditions.



Loaded for versatility

Get the most out of your wheel loader with a range of purpose built attachments. Form one solid and reliable unit, with attachments that are ideally matched by size and design to your machine's parameters – including link-arm geometry, breakout and lifting forces. And if we don't have the right attachment, Volvo can custom build one to your specific requirements.

Fork applications

Take your pick from a range of Volvo forks, offering stability and good visibility. Achieve precise control and ultimate productivity, thanks to the reach and parallel lift-arm action of the loader unit, offering the perfect combination with fork attachments.



Rehandling

Experience up to 5% greater productivity with a new range of Volvo Rehandling buckets. The redesigned buckets are easier to fill and minimize spillage, thanks to new convex sides and the improved spill guard. To prevent spillage and absorb shocks, opt for the Boom Suspension System, which automatically engages, depending on gear or speed selection.



Waste and recycling

Put waste in its place with a full line of dedicated attachments and machine configurations. Designed specifically for waste handling, the robust attachments will ensure efficient and productive operation.



Log handling

Designed for high lifting force and tilt out force, and offering maximum stability in log handling applications, select from a choice of general purpose grapples, sorting grapples and unloading grapples.





TORQUE PARALLEL LINKAGE

For strength in demanding applications, Volvo's unique Torque Parallel (TP) linkage provides high breakout torque and ultimate parallel movement throughout the entire lifting range. The linkage offers stability during loading and carrying and allows easy filling of the buckets. For long lasting performance, the lifting arm has double sealing on each of the pins.

Intelligently productive

UP TO 20% GREATER FUEL EFFICIENCY

- Rimpull control
- New generation OptiShift
- Eco pedal
- Reverse By Braking (RBB)
- Dry P-brake
- Matched Volvo attachments

MAXIMIZE YOUR UPTIME

- 1000hr engine oil change interval
- Quicker hydraulic oil fill thanks to new mounted nipple
- Electronically-operated engine hood
- Slidable cooler installation
- Brake wear indicators
- Outboard mounted brakes
- Replaceable breather filters



BOOST YOUR PRODUCTIVITY BY UP TO 5%

- New transmission and gear ratio
- Choice of single or multi levers
- Choice of three hydraulic modes
- Bucket leveling function

PERFECT YOUR PERFORMANCE

- Load Assist, powered by Volvo Co-Pilot
- New rear view mirrors
- Comfort Drive Control - Option
- Radar detect system, Rear-view camera - Options



HERE TO SUPPORT YOU

- Genuine Volvo Parts
- Operator training
- ActiveCare Direct

LOADED FOR VERSATILITY

- Unique Torque Parallel linkage
- New Rehandling bucket – up to 5% greater productivity
- Fork attachments
- Waste and recycling
- Log handling
- Custom built attachments

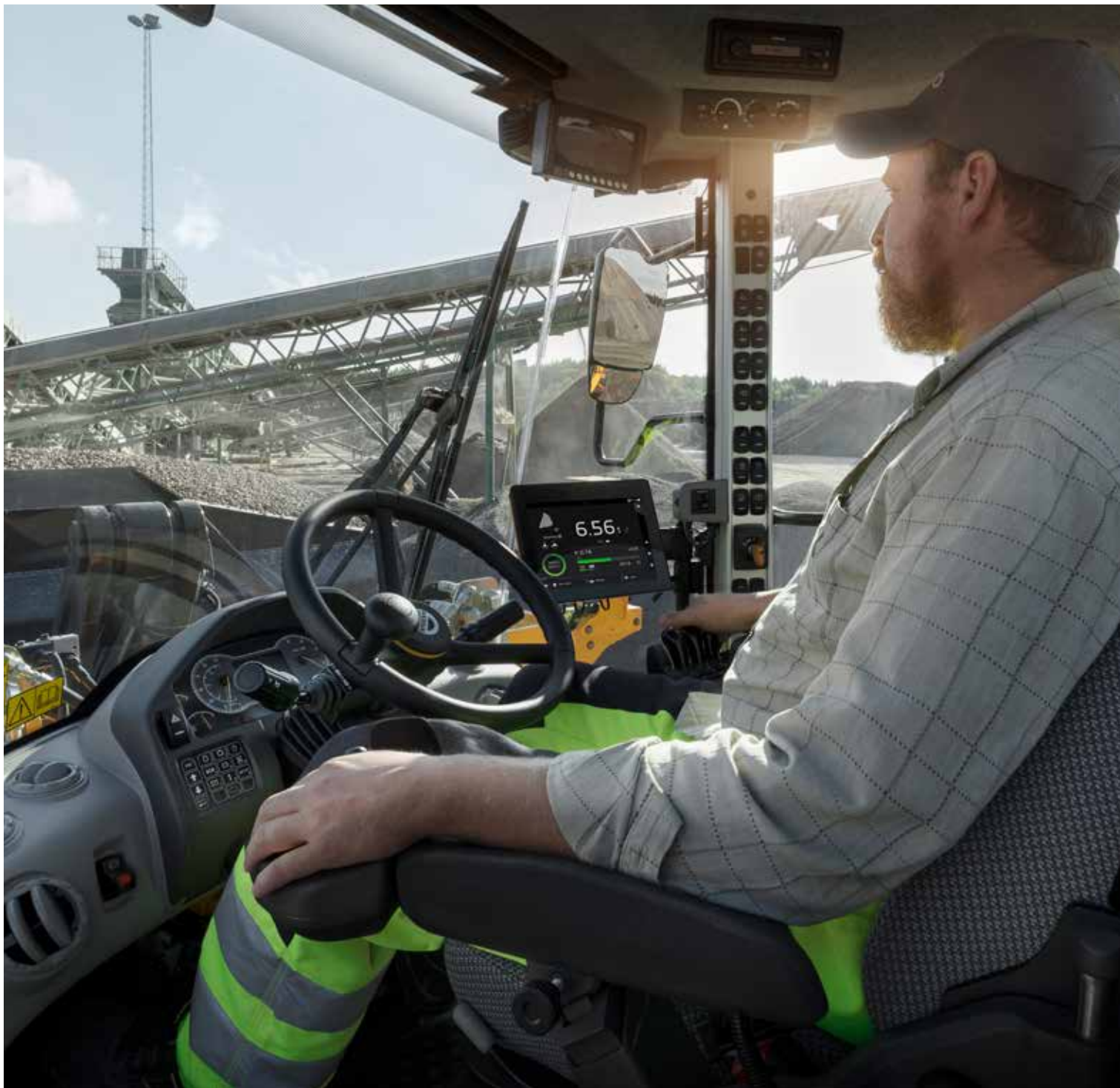

THE OPERATOR'S CHOICE

Operate in comfort from the best cab on the market, the Volvo cab can be equipped with a new adjustable seat. Access the cab safely and effortlessly using the steps and open the door with ease, thanks to the optional remote-control opener.

Perfect your performance

Built with the customer, for the customer, the L110H and L120H boast a range of features to enhance operator performance. For increased productivity, the Volvo cab can be customized to your preference and additional cameras offer greater visibility.

Visibility

To enhance visibility, the H-series wheel loaders can be equipped with a rear-view camera. Optimized by the radar detect system, which works with the camera to give a visual and audible alert to the operator of unseen on-coming objects. Orange handrails and steps have been placed on the machine, intended to stand out to the operators and maintenance staff.



Comfort Drive Control

To reduce operator fatigue and improve productivity, Comfort Drive Control can be optionally integrated into your machine. The smart function gives you the opportunity to steer the machine from a small lever – particularly effective for fast-paced truck loading operations.



Operator training

Increase productivity and reduce fuel consumption by learning how to operate your wheel loader in the most efficient way. Volvo offers operator training, which encompasses the best practices in the industry.



Maximize your uptime

Offering strength in demanding applications, the L110H and L120H are built to last. Maintain the life of your machines with simple serviceability and proactive dealer support, as well as flexible maintenance and repair plans.

Durable by design

Designed with durability in mind, the H-series wheel loaders are built with a Lifetime Frame and Structure Warranty, including the front frame, rear frame, articulation joint and loader arm. The hydraulically-driven cooling fan regulates component temperature and can be automatically reversed to permit self-cleaning of the cooling units. For long service life, the brakes are outboard mounted and the front and rear axles are cooled by the oil circulation.



ActiveCare Direct

Keep your machine moving with ActiveCare Direct. Volvo monitors machine health remotely, from our very own Uptime Center, helping to predict potential failures before they occur. This gives you more time to focus on your operation, helping to reduce unplanned downtime and minimize repair costs.



Here to support you

Maintain productivity and machine uptime with our range of Genuine Volvo Parts – all backed by Volvo warranty, with 24-hour parts delivery guarantee. We're here to help you stay on track, offering flexible maintenance and repair plans.



Slidable cooler installation

The cooler installation slides out, for ease and speed of cleaning.





"After deciding to buy our first Volvo machine, we couldn't be more pleased with the results. Not only is the fuel economy great, more importantly, so is the customer service, which has helped us to keep machine downtime to a minimum."

Wade Englesby, Operations Manager, Terriva Metals Recycling (Canada)



INDUSTRY LEADING SERVICEABILITY

For simple serviceability, the engine hood is operated electronically. Stay one step ahead and check the condition of your brakes using the brake wear indicators, placed on the wheels. To prevent dirt and moisture from entering components, each has replaceable breather filters, located remotely.

Volvo L110H, L120H in detail

Engine

The engine is a straight six cylinder, four stroke, turbo charged diesel engine with direct injection and charge air cooler. The engine meet US Tier 4 final and California Tier 4 final emission requirements and EU Stage IV emission requirements.

The engine uses a common rail fuel system controlled by the engine control module (ECM). Engines with ACT (advanced combustion technology) feature split injection and turbocharger with mechanical wastegate. The exhaust after treatment system (EATS) is equipped with a diesel oxidation catalyst (DOC), a diesel particulate filter (DPF) and a SCR system to reduce emissions. Cooled exhaust gas recirculation (EGR) also reduces emissions. The engine is a straight six cylinder, four stroke, turbo charged diesel engine with direct injection and charge air cooler. The engine meet US Tier 4 final and California Tier 4 final emission requirements and EU Stage IV emission requirements. The engine uses a common rail fuel system controlled by the engine control module (ECM). Engines with ACT (advanced combustion technology) feature split injection and turbocharger with mechanical wastegate. The exhaust after treatment system (EATS) is equipped with a diesel oxidation catalyst (DOC), a diesel particulate filter (DPF) and a SCR system to reduce emissions. Cooled exhaust gas recirculation (EGR) also reduces emissions.

L110H

Engine	Volvo	D8J
Max. power at	r/min (r/s)	1,800 (30)
SAE J1995 gross	kW (hp)	191 (256)
ISO 9249, SAE J1349 net	kW (hp)	191 (256)
Max. torque at	r/min (r/s)	1,450 (24.2)
SAE J1995 gross	Nm (ft lbf)	1,255 (926)
ISO 9249, SAE J1349 net	Nm (ft lbf)	1,250 (922)
Economic working range	r/min (r/s)	850 - 2,100 (14.2 - 35)
Displacement	l (in ³)	7.8 (473)

L120H

Engine	Volvo	D8J
Max. power at	r/min (r/s)	1,500 (25)
SAE J1995 gross	kW (hp)	203 (272)
ISO 9249, SAE J1349 net	kW (hp)	203 (272)
Max. torque at	r/min (r/s)	1,450 (24.2)
SAE J1995 gross	Nm (ft lbf)	1,320 (974)
ISO 9249, SAE J1349 net	Nm (ft lbf)	1,317 (971)
Economic working range	r/min (r/s)	850 - 2,100 (14.2 - 35)
Displacement	l (in ³)	7.8 (473)

L110H

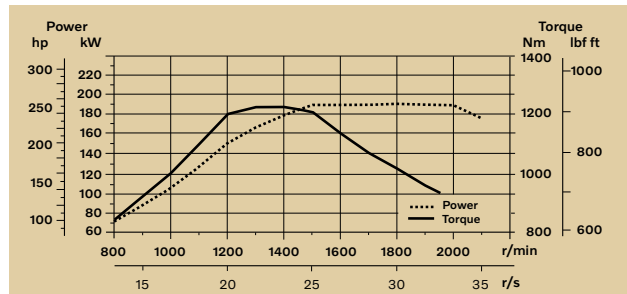

L120H

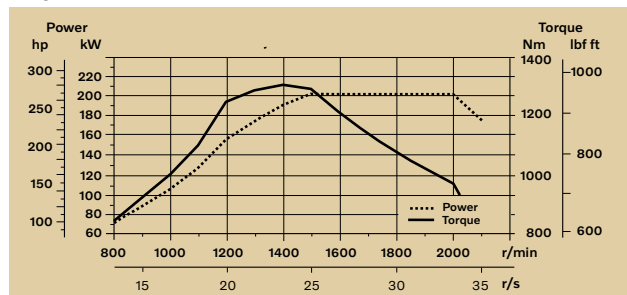

Drivetrain

Torque converter: Single-stage.

Transmission: Volvo countershaft transmission with single lever control. Fast and smooth shifting of gears with Pulse Width Modulation (PWM) valve.

Transmission: Volvo Automatic Power Shift (APS) with fully automatic shifting 1-4 and mode selector with 4 different gear shifting programs, including AUTO. Also equipped with Rimpull control to avoid wheel spin and optimize bucket filling. OptiShift transmission is also available as an option.

Axles: Volvo fully floating axle shafts with planetary hub reductions and cast steel axle housing. Fixed front axle and oscillating rear axle. 100% differential lock on the front axle.

		L110H	L120H
Transmission	Volvo	HTE 206C	HTE 206C
Torque multiplication, stall ratio		2.47:1	2.47:1
Maximum speed, forward/reverse			
1st gear	km/h (mi/h)	7 (4.3)	7 (4.3)
2nd gear	km/h (mi/h)	13.5 (8.4)	13.5 (8.4)
3rd gear	km/h (mi/h)	28 (17.4)	28 (17.4)
4th gear	km/h (mi/h)	40 (24.9)	40 (24.9)
Note: 4th gear limited by ECU			
Measured with tires		750/65R25	750/65R25
Front axle/rear axle		AWB 31/ AWB 30	AWB 31/ AWB 30
Rear axle oscillation	± °	13	13
Ground clearance	mm (in)	460 (18.1)	460 (18.1)
at oscillation	°	13	130

Electrical system

Central warning system: Contrinsic electrical system with central warning light and buzzer for following functions: - Serious engine fault - Low steering system pressure - Over speed warning engine - Interruption in communication (computer fault) Central warning light and buzzer with the gear engaged for the following functions. - Low engine oil pressure - High engine oil temperature - High charge air temperature - Low coolant level - High coolant temperature - High crank case pressure - Low transmission oil pressure - High transmission oil temperature - Low brake pressure - Engaged parking brake - Fault on brake charging - Low hydraulic oil level - High hydraulic oil temperature - Overspeeding in engaged gear - High brake cooling oil temperature front and rear axles.

		L110H	L120H
Voltage	V	24	24
Batteries	V	2 x 12	2 x 12
Battery capacity	Ah	2 x 170	2 x 170
Cold cranking capacity, approx	A	1,000	1,000
Alternator rating	W/A	2,280/80	2,280/80
Starter motor output	kW	5.5	5.5

Brake System

Service brake: Volvo dual-circuit system with nitrogen charged accumulators. Outboard mounted hydraulically operated, fully sealed oil circulation cooled wet disc brakes. The operator can select automatic declutch of the transmission when braking by selecting the setting in the contronics.

Parking brake: Dry disc brake. Applied by spring force, electro-hydraulic release with a switch on the instrument panel.

Secondary brake: Dual brake circuits with rechargeable accumulators. One circuit or the parking brake fulfills all safety requirements.

Standard: The brake system complies with the requirements of ISO 3450.

		L110H	L120H
Number of brake discs per wheel front		1	1
Accumulators	l (gal)	3 x 1.0 (3 x 0.26)	3 x 1.0 (3 x 0.26)

Cab

Instrumentation: All important information is centrally located in the operator's field of vision. Display for Contronic monitoring system.
Heater and defroster: Heater coil with filtered fresh air and fan with auto and manual(11 speed) setting. Defroster vents for all window areas.
Operator's seat: Operator's seat with adjustable suspension and retractable seatbelt. The seat is mounted on a bracket on the rear cab wall and floor. The forces from the retractable seatbelt are absorbed by the seat rails.
Standard: The cab is tested and approved according to ROPS (ISO 3471, SAE J1040), FOPS (ISO 3449). The cab meets with requirements according to ISO 6055 (Operator overhead protection - Industrial trucks) and SAE J386 ("Operator Restraint System").

		L110H	L120H
Emergency exit: Use emergency hammer to break window			
Ventilation	m ³ /min (yd ³ /min)	9 (11.8)	9 (11.8)
Heating capacity	kW	16	16
Air conditioning (optional)	kW	7.5	7.5

Lift Arm System

Torque Parallel linkage (TP-linkage) with high breakout torque and parallel movement throughout the entire lifting range.

		L110H	L120H
Lift cylinders		2	2
Cylinder bore	mm (in)	150 (5.9)	150 (5.9)
Piston rod diameter	mm (in)	80 (3.1)	80 (3.1)
Stroke	mm (in)	676 (26.6)	676 (26.6)
Tilt cylinder		1	1
Cylinder bore	mm (in)	210 (8.3)	210 (8.3)
Piston rod diameter	mm (in)	110 (4.3)	110 (4.3)
Stroke	mm (in)	412 (16.2)	412 (16.2)

Hydraulic system

System supply: Two load-sensing axial piston pumps with variable displacement. The steering system always has priority.
Valves: Double-acting 2-spool valve. The main valve is controlled by a 2-spool pilot valve.
Lift function: The valve has four positions; raise, hold, lower and floating position. Inductive/magnetic automatic boom kickout can be switched on and off and is adjustable to any position between maximum reach and full lifting height.
Tilt function: The valve has three functions including rollback, hold and dump. Inductive/magnetic automatic tilt can be adjusted to the desired bucket angle.
Cylinders: Double-acting cylinders for all functions
Filter: Full flow filtration through 10 micron (absolute) filter cartridge.

		L110H	L120H
Working pressure maximum, pump 1 for working hydraulic system	MPa (bar)	27.0 ± 0.5 (270 ± 5)	29.0 ± 0.5 (290 ± 5)
Flow	l/min (gal/min)	128 (33.8)	128 (33.8)
at	MPa (bar)	10 (100)	10 (100)
engine speed	r/min (r/s)	1,900 (31.7)	1,900 (31.7)
Working pressure maximum, pump 2 for steering-, brake-, pilot- and working hydraulic system	MPa (bar)	29.0 ± 0.5 (290 ± 5)	31.0 ± 0.5 (310 ± 5)
Flow	l/min (gal/min)	128 (33.8)	128 (33.8)
at	MPa (bar)	10 (100)	10 (100)
engine speed	r/min (r/s)	1,900 (31.7)	1,900 (31.7)
Working pressure maximum, pump 3 for brake- and cooling fan system	MPa (bar)	21.0 ± 0.5 (210 ± 5)	21.0 ± 0.5 (210 ± 5)
Flow	l/min (gal/min)	33 (8.7)	33 (8.7)
at	MPa (bar)	10 (100)	10 (100)
engine speed	r/min (r/s)	1,900 (31.7)	1,900 (31.7)
Pilot system, working pressure	MPa (bar)	3.5 (35)	3.5 (35)
Cycle times			
Lift	s	5.4	5.4
Tilt	s	2.1	2.1
Lower, empty	s	2.5	2.5
Total cycle time	s	10	10

Steering System

Steering system: Load-sensing hydrostatic articulated steering.
System supply: The steering system has priority feed from a load-sensing axial piston pump with variable displacement.
Steering cylinders: Two double-acting cylinders.

		L110H	L120H
Steering cylinders		2	2
Cylinder bore	mm (in)	80 (3.1)	80 (3.1)
Rod diameter	mm (in)	50 (2)	50 (2)
Stroke	mm (in)	486 (19.1)	486 (19.1)
Working pressure	MPa (bar)	21 (210)	21 (210)
Maximum flow	l/min (gal/min)	120 (31.7)	120 (31.7)
Maximum articulation	± °	40	40

Service Refill

Service accessibility: Electrically openable engine hood with large opening angle giving excellent access to the engine compartment. Fluid filters and component breather air filters promote long service intervals. A quick-fit adapter on the hydraulic tank provides faster hydraulic oil fill.
 Possibility to monitor, log and analyze data to facilitate troubleshooting.

		L110H	L120H
Fuel tank	l (gal)	270 (71.3)	270 (71.3)
DEF/AdBlue® tank	l (gal)	25 (6.6)	25 (6.6)
Engine coolant	l (gal)	43 (11.4)	43 (11.4)
Hydraulic oil tank	l (gal)	133 (35.1)	133 (35.1)
Transmission oil	l (gal)	38 (10)	38 (10)
Engine oil	l (gal)	22 (5.8)	22 (5.8)
Axle oil front	l (gal)	36 (9.5)	36 (9.5)
Axle oil rear	l (gal)	41 (10.8)	41 (10.8)

Sound Level

		L110H	L120H
Sound pressure level in cab according to ISO 6396			
L _{pA}	dB	68	68
External sound level according to ISO 6395 and EU Noise Directive 2000/14/EC			
L _{WA}	dB	106	106

Specifications

		L110H		L120H	
Tires 23.5 R25 L3					
		Standard boom		Long boom	
		Standard boom		Long boom	
B	mm ft in	6,480 21'3"	7,010 23'0"	6,580 21'7"	7,070 23'2"
C	mm ft in	3,200 10'6"	3,200 10'6"	3,200 10'6"	3,200 10'6"
D	mm ft in	430 1'5"	430 1'5"	440 1'5"	440 1'5"
F	mm ft in	3,380 11'1"	3,380 11'1"	3,380 11'1"	3,390 11'1"
G	mm ft in	2,131 7'0"	2,134 7'0"	2,132 7'0"	2,133 7'0"
J	mm ft in	3,700 12'2"	4,240 13'11"	3,760 12'4"	4,310 14'2"
K	mm ft in	4,030 13'3"	4,550 14'11"	4,100 13'5"	4,630 15'2"
O	°	55	54	54	55
Pmax	°	50	46	50	49
R	°	40	41	42	42
R1*	°	44	48	45	50
S	°	66	64	68	64
T	mm ft in	98 0'3.9"	89 0'3.5"	119 0'4.7"	127 0'5"
U	mm ft in	430 1'5"	610 2'0"	450 1'6"	640 2'1"
X	mm ft in	2,070 6'9"	2,070 6'9"	2,070 6'9"	2,070 6'9"
Y	mm ft in	2,670 8'9"	2,670 8'9"	2,670 8'9"	2,670 8'9"
Z	mm ft in	3,310 10'10"	3,820 12'6"	3,340 10'11"	3,720 12'3"
a ₂	mm ft in	5,730 18'10"	5,730 18'10"	5,730 18'10"	5,730 18'10"
a ₃	mm ft in	3,060 10'1"	3,060 10'1"	3,060 10'1"	3,060 10'1"
a ₄	±°	40	40	40	40
		Standard boom with 3.0 m ³ / 3.9 yd ³ STE H T bucket	Long boom with 2.6 m ³ / 3.4 yd ³ STE P BOE bucket	Standard boom with 3.3 m ³ / 4.3 yd ³ STE H T bucket	Long boom with 2.6 m ³ / 3.4 yd ³ STE P BOE bucket

* Carry position SAE

Where applicable, specifications and dimensions are according to ISO 7131, SAE J732, ISO 7546, SAE J742, ISO 14397, SAE J818.

L110H

Sales code: WLA80832

Operating weight

(incl. logging cw 685 kg / 1,510 lb): 19,916 kg / 43,920 lb

Operating load: 5,850 kg / 12,900 lb

L120H

Sales code: WLA80832

Operating weight

(incl. logging cw 685 kg / 1,510 lb): 20,713 kg / 45,660 lb

Operating load: 6,400 kg / 14,110 lb

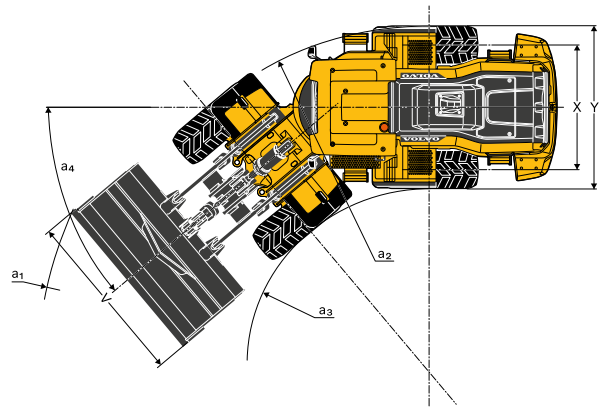
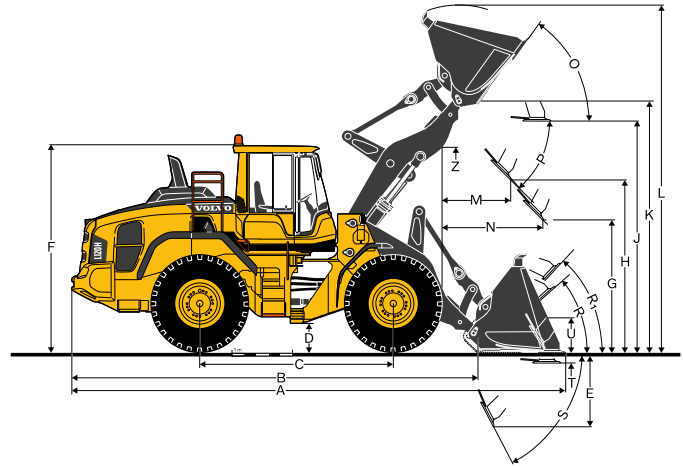

		L110H		L120H	
Tires: 750/65 R25					
A	m ² ft ²	2.4	25.8	2.4	25.8
B	mm in	3,470	11'5"	3,470	11'8"
C	mm in	1,850	6'1"	1,850	6'2"
D	mm in	2,850	9'4"	2,850	9'7"
E	mm in	1,460	4'10"	1,460	4'11"
F	mm in	1,520	5'0"	1,520	5'0"
G	mm in	2,720	8'11"	2,720	9'2"
H	mm in	4,580	15'0"	4,580	15'3"
I	mm in	6,620	21'9"	6,620	21'11"
J	mm in	2,790	9'2"	2,790	9'2"
K	mm in	2,990	9'10"	2,990	9'10"
L	mm in	2,060	6'9"	2,060	7'1"
M	mm in	8,770	28'9"	8,770	29'1"

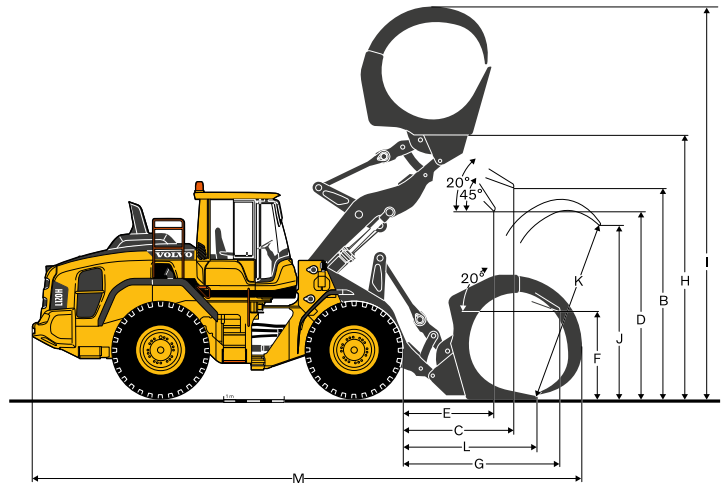

Specifications L110H

L110H

Tires 23.5R25 XHA2 L3		REHA		GENERAL PURPOSE						ROCK**		LIGHT MATERIAL		LONG BOOM***	
		3.5 m ³ 4.6 yd ³ STE P BOE	3.5 m ³ 4.6 yd ³ STE H BOE	3.0 m ³ 3.9 yd ³ STE P T	3.0 m ³ 3.9 yd ³ STE H T	3.4 m ³ 4.4 yd ³ STE P BOE	3.4 m ³ 4.4 yd ³ STE H BOE	2.7 m ³ 3.5 yd ³ SPN P T SEG	5.5 m ³ 7.2 yd ³ LM H	9.5 m ³ 12.4 yd ³ LM H					
Volume, heaped ISO/SAE	m ³ yd ³	3.5 4.6	3.5 4.6	3.0 3.9	3.0 3.9	3.4 4.4	3.4 4.4	2.7 3.5	5.5 7.2	9.5 12.4	-	-			
Volume at 110% fill factor	m ³ yd ³	3.9 5.0	3.9 5.0	3.3 4.3	3.3 4.3	3.7 4.9	3.7 4.9	3.0 3.9	6.1 7.9	10.5 13.7	-	-			
Static tipping load, straight	kg lb	14 780 32,590	14 070 31,020	13 770 30,370	13 100 28,890	13 350 29,430	12 680 27,960	13 780 30,390	11 980 26,410	12 070 26,620	-2 540	-5 588			
at 35° turn	kg lb	13 140 28,970	12 470 27,500	12 270 27,050	11 640 25,670	11 860 26,140	11 240 24,780	12 240 26,980	10 550 23,260	10 610 23,400	-2 330	-5 126			
at full turn	kg lb	12 650 27,890	12 000 26,470	11 820 26,070	11 210 24,720	11 420 25,170	10 810 23,830	11 780 25,970	10 130 22,340	10 180 22,450	-2 270	-4 994			
Breakout force	kN lb	162.0 36,430	149.7 33,670	175.8 39,530	161.0 36,210	157.7 35,460	145.9 32,800	143.1 32,170	115.0 25,850	100.3 22,550	-	-			
A	mm ft.in	8 040 26'5"	8 150 26'9"	8 120 26'8"	8 220 27'0"	8 010 26'3"	8 120 26'8"	8 310 27'3"	8 500 27'11"	8 800 28'10"	510	1'8"			
E	mm ft.in	1 220 4'0"	1 320 4'4"	1 350 4'5"	1 450 4'9"	1 260 4'2"	1 360 4'6"	1 510 5'0"	1 700 5'7"	1 960 6'5"	-10	-4/10"			
H	mm ft.in	2 820 9'3"	2 750 9'0"	2 720 8'11"	2 660 8'9"	2 790 9'2"	2 720 8'11"	2 610 8'7"	2 420 7'11"	2 220 7'3"	510	1'8"			
L	mm ft.in	5 440 17'10"	5 510 18'1"	5 550 18'2"	5 610 18'5"	5 620 18'5"	5 670 18'7"	5 550 18'2"	5 850 19'2"	6 010 19'9"	520	1'9"			
M	mm ft.in	1 170 3'10"	1 250 4'1"	1 260 4'2"	1 350 4'5"	1 200 3'11"	1 280 4'2"	1 400 4'7"	1 520 5'0"	1 730 5'8"	-30	-0'1"			
N	mm ft.in	1 710 5'8"	1 760 5'9"	1 750 5'9"	1 800 5'11"	1 730 5'8"	1 770 5'9"	1 810 5'11"	1 800 5'11"	1 820 6'0"	450	1'6"			
V	mm ft.in	3 000 118"	3 000 118"	2 880 113"	2 880 113"	2 880 113"	2 880 113"	2 880 113"	3 000 118"	3 000 118"	-	-			
a ₁ clearance circle	mm ft.in	12 930 42'5"	12 980 42'7"	12 710 41'8"	12 770 41'11"	12 660 41'6"	12 710 41'8"	12 830 42'1"	13 060 42'10"	13 610 44'8"	440	1'5"			
Operating weight	kg lb	19 270 42,490	19 510 43,010	18 360 40,480	18 560 40,930	18 560 40,920	18 760 41,370	19 560 43,130	19 100 42,120	19 320 42,610	300	660			

* Measured with additional rehandling counterweight | ** With MICHELIN 23,5R25 XMINE D2 L5 Tire | *** Based on 3.0 m³ / 3.9 yd³ STE H T bucket

Bucket Selection Chart

The chosen bucket is determined by the density of the material and the expected bucket fill factor. The actual bucket volume is often larger than the rated capacity, due to the features of the TP linkage, including an open bucket design, good rollback angles in all positions and good bucket filling performance. The example represents a standard boom configuration. Example: Sand and gravel. Fill factor ~ 105%. Density 1.6 t/m³ (2,700 lb/yd³). Result: The 3.4 m³ (4.5 yd³) bucket carries 3.6 m³ (4.7 yd³). For optimum stability always consult the bucket selection chart.

Material	Bucket fill, %	Material density		ISO/SAE bucket volume		Actual volum ^e	
		t/m ³	lb/yd ³	m ³	yd ³	m ³	yd ³
Earth/Clay	~ 110	1.8	3,030	3.0	3.9	3.3	4.3
		1.6	2,700	3.4	4.5	3.7	4.8
Sand/Gravel	~ 105	1.8	3,030	3.0	3.9	3.2	4.2
		1.6	2,700	3.4	4.5	3.6	4.7
Aggregate	~ 100	1.8	3,030	3.5	4.6	3.5	4.6
		1.6	2,700				
Rock	≤100	1.7	2,866	2.7	3.5	2.7	3.5

The size of rock buckets is optimized for optimal penetration and filling capability rather than the density of the material.

Type of boom	Type of bucket	ISO/SAE Bucket volume	Material density: t/m ³ (lb/yd ³)					
			L110H 0.8 (1,349)	1.0 (1,686)	1.2 (2,024)	1.4 (2,361)	1.6 (2,698)	1.8 (3,035)
Standard boom	Rehandling	P 3.5 m ³ (4.6 yd ³)				3.7 (4.8)	3.5 (4.6)	
		H 3.5 m ³ (4.6 yd ³)				3.7 (4.8)	3.5 (4.6)	
	General purpose	P 3.0 m ³ (3.9 yd ³)					3.3 (4.3)	3.0 (3.9)
		H 3.0 m ³ (3.9 yd ³)					3.3 (4.3)	3.0 (3.9)
		P 3.4 m ³ (4.5 yd ³)				3.7 (4.8)	3.4 (4.5)	
		H 3.4 m ³ (4.5 yd ³)				3.7 (4.8)	3.4 (4.5)	
Rock	P 2.7 m ³ (3.5 yd ³)						2.7 (3.5)	2.6 (3.3)
Light material	H 5.5 m ³ (7.2 yd ³)	10.0 (13.0)		5.8 (7.6)	5.5 (7.2)			
	H 9.5 m ³ (12.4 yd ³)		9.5 (12.4)					
Long boom	Rehandling	P 3.5 m ³ (4.6 yd ³)				3.7 (4.8)	3.5 (4.6)	
		P 3.0 m ³ (3.9 yd ³)					3.3 (4.3)	3.0 (3.9)
	P 3.4 m ³ (4.5 yd ³)				3.7 (4.9)	3.4 (4.5)		
	Rock	P 2.7 m ³ (3.5 yd ³)					2.7 (3.5)	
	Light material	H 5.5 m ³ (7.2 yd ³)		5.8 (7.6)		5.5 (7.2)		











How to read bucket fill factor

Supplemental Operating Data

Tires 23.5 R25 L3			Standard boom				Long boom			
			23.5 R25 L5		750/65 R25		750/65 R25		750/65 R25	
Width over tires	mm in		30	1.2	200	7.9		200	7.9	
Ground clearance	mm in		50	2	±0	±0		±0	±0	
Tipping load, full turn	kg lb		490	1,078	430	946		310	682	
Operating weight	kg lb		670	1,474	640	1,408		640	1,408	

Specifications L120H





L120H

Tires 23.5R25 XHA2 L3	REHANDLING*		GENERAL PURPOSE						ROCK**		LIGHT MATERIAL		LONG BOOM***								
																					
	3.8 m ³ 5.0 yd ³ STE P BOE	3.8 m ³ 5.0 yd ³ STE H BOE	3.3 m ³ 4.3 yd ³ STE P T	3.3 m ³ 4.3 yd ³ STE H T	3.6 m ³ 4.7 yd ³ STE P BOE	3.6 m ³ 4.7 yd ³ STE H BOE	3.0 m ³ 3.9 yd ³ SPN P T SEG	5.5 m ³ 7.2 yd ³ LM H	9.5 m ³ 12.4 yd ³ LM H												
Volume, heaped ISO/SAE	m ³	3.8	5.0	3.8	5.0	3.3	4.3	3.3	4.3	3.6	4.7	3.6	4.7	3.0	3.9	5.5	7.2	9.5	12.4	-	-
Volume at 110% fill factor	m ³	4.2	5.5	4.2	5.5	3.6	4.7	3.6	4.7	4.0	5.2	4.0	5.2	3.3	4.3	6.1	7.9	10.5	13.7	-	-
Static tipping load, straight	kg	15 660	34,530	14 960	32,980	14 800	32,630	14 450	31,870	14 810	32,660	14 080	31,040	14 860	32,760	13 010	28,690	13 120	28,940	-2 680	-5,896
at 35° turn	kg	13 870	30,570	13 210	29,140	13 120	28,940	12 790	28,210	13 110	28,920	12 430	27,410	13 160	29,020	11 440	25,230	11 510	25,390	-2 440	-5,368
at full turn	kg	13 340	29,400	12 700	28,000	12 630	27,850	12 300	27,120	12 610	27,810	11 950	26,340	12 660	27,920	10 980	24,200	11 040	24,340	-2 370	-5,214
Breakout force	kN	162.4	36,510	151.8	34,120	189.2	42,530	173.5	39,010	172.9	38,870	159.6	35,880	150.6	33,870	121.6	27,340	106.0	23,840	-	-
A	mm	8 170	26'10"	8 320	27'3"	8 230	27'0"	8 340	27'4"	8 050	26'5"	8 160	26'9"	8 390	27'6"	8 610	28'3"	8 910	29'3"	460	1'6"
E	mm	1 250	4'1"	1 400	4'7"	1 380	4'6"	1 480	4'10"	1 230	4'0"	1 330	4'4"	1 520	5'0"	1 730	5'8"	1 990	6'6"	-20	-8'10"
H	mm	2 890	9'6"	2 770	9'1"	2 780	9'1"	2 700	8'10"	2 900	9'6"	2 830	9'3"	2 690	8'10"	2 480	8'2"	2 270	7'6"	560	1'10"
L	mm	5 750	18'10"	5 780	18'11"	5 700	18'8"	5 760	18'11"	5 750	18'10"	5 820	19'1"	5 690	18'8"	5 900	19'4"	6 070	19'11"	520	1'9"
M	mm	1 250	4'1"	1 330	4'4"	1 310	4'3"	1 390	4'7"	1 190	3'11"	1 280	4'2"	1 440	4'9"	1 560	5'1"	1 760	5'9"	-50	-0'2"
N	mm	1 850	6'1"	1 860	6'1"	1 840	6'0"	1 880	6'2"	1 800	5'11"	1 840	6'0"	1 930	6'4"	1 890	6'2"	1 910	6'3"	450	1'6"
V	mm	3 000	118"	3 000	118"	3 000	118"	3 000	118"	3 000	118"	3 000	118"	2 880	113"	3 000	118"	3 400	133"	-	-
a ₁ clearance circle	mm	13 040	42'9"	13 090	42'11"	12 890	42'3"	12 950	42'6"	12 800	42'0"	12 850	42'2"	12 890	42'3"	13 130	43'1"	13 660	44'10"	410	1'4"
Operating weight	kg	20 110	44,350	20 330	44,820	19 280	42,510	19 460	42,900	19 420	42,830	19 640	43,300	20 260	44,680	19 900	43,880	20 120	44,360	240	528

* Measured with additional rehandling counterweight | ** With MICHELIN 23,5R25 XMINE D2 L5 Tire | *** Based on 3,3 m³ / 4.3 yd³ STE H T bucket

Bucket Selection Chart

The chosen bucket is determined by the density of the material and the expected bucket fill factor. The actual bucket volume is often larger than the rated capacity, due to the features of the TP linkage, including an open bucket design, good rollback angles in all positions and good bucket filling performance. The example represents a standard boom configuration. Example: Sand and gravel. Fill factor ~ 105%. Density 1.6 t/m³ (2,700 lb/yd³). Result: The 3.4 m³ (4.5 yd³) bucket carries 3.6 m³ (4.7 yd³). For optimum stability always consult the bucket selection chart.

Material	Bucket fill, %		Material density ^t		ISO/SAE bucket volume		Actual volum ^e	
			t/m ³	lb/yd ³	m ³	yd ³	m ³	yd ³
Earth/Clay	~ 110		1.8	3,030	3.3	4.3	3.6	4.7
			1.6	2,700	3.6	4.7	3.9	5.1
Sand/Gravel	~ 105		1.8	3,030	3.3	4.3	3.5	4.6
			1.6	2,700	3.6	4.7	3.8	5.0
Aggregate	~ 100		1.8	3,030	3.8	5.0	3.8	5.0
			1.6	2,700				
Rock	≤ 100		1.7	2,866	3.0	3.9	3.0	3.9

The size of rock buckets is optimized for optimal penetration and filling capability rather than the density of the material.

Type of boom	Type of bucket	ISO/SAE Bucket volume	Material density: t/m ³ (lb/yd ³)						
			0.8 (1,349)	1.0 (1,686)	1.2 (2,024)	1.4 (2,361)	1.6 (2,698)	1.8 (3,035)	2.0 (3,373)
Standard boom	Rehandling	P 3.8 m ³ (5.0 yd ³)					4.0 (5.2)	3.8 (5.0)	
		H 3.8 m ³ (5.0 yd ³)					4.0 (5.2)	3.8 (5.0)	
	General purpose	P 3.3 m ³ (4.3 yd ³)						3.6 (4.7)	3.3 (4.3)
		H 3.3 m ³ (4.3 yd ³)						3.6 (4.7)	3.3 (4.3)
	Rock	P 3.6 m ³ (4.7 yd ³)					4.0 (5.2)	3.6 (4.7)	
		H 3.6 m ³ (4.7 yd ³)					4.0 (5.2)	3.6 (4.7)	2.8 (3.7)
Long boom	Light material	H 5.5 m ³ (7.2 yd ³)	10.0 (13.0)	5.8 (7.6)	5.5 (7.2)				
		H 9.5 m ³ (12.4 yd ³)		9.5 (12.4)					
	Rehandling	P 3.8 m ³ (5.0 yd ³)					4.0 (5.2)	3.8 (5.0)	
		General purpose	P 3.3 m ³ (4.3 yd ³)					3.6 (4.7)	3.3 (4.3)
P 3.6 m ³ (4.7 yd ³)						4.0 (5.2)	3.6 (4.7)		
Rock	P 3.0 m ³ (3.9 yd ³)						3.1 (4.1)	3.0 (3.9)	
	Light material	H 5.5 m ³ (7.2 yd ³)	5.3 (7.6)	5.5 (7.2)					

How to read bucket fill factor

Supplemental Operating Data

Tires 23.5 R25 L3	Standard boom				Long boom			
	23.5 R25 L5		750/65 R25		750/65 R25		750/65 R25	
Width over tires	mm	in	30	1.2	200	7.9	200	7.9
Ground clearance	mm	in	50	2	±0	±0	±0	±0
Tipping load, full turn	kg	lb	450	990	380	836	330	726
Operating weight	kg	lb	670	1,474	640	1,408	640	1,408

Equipment

STANDARD EQUIPMENT			
	L110H	L120H	
Engine			
Exhaust after-treatment system	•	•	
Three stage air cleaner, pre-cleaner, primary and secondary filter	•	•	
Indicator for coolant level	•	•	
Preheating of induction air	•	•	
Fuel pre-filter with water trap	•	•	
Fuel filter	•	•	
Crankcase breather oil trap	•	•	
Exterior radiator air intake protection	•	•	
Drivetrain			
Automatic Power Shift	•	•	
Fully automatic gearshifting, 1-4	•	•	
PWM-controlled gearshifting	•	•	
Forward and reverse switch by hydraulic lever console	•	•	
Rimpull control	•	•	
Indicator glass for transmission oil level	•	•	
Differentials: Front, 100% hydraulic diff lock. Rear, conventional.	•	•	
Lock-up first gear	•	•	
Electrical system			
24 V, pre-wired for optional accessories	•	•	
Alternator 24V/80A/2280W	•	•	
Battery disconnect switch	•	•	
Fuel gauge	•	•	
Hour meter	•	•	
Electric horn	•	•	
Instrument cluster:			
Fuel level			
Diesel Exhaust Fluid/AdBlue level	•	•	
Transmission temperature			
Coolant temperature			
Instrument lighting			
Lighting:			
Twin halogen front headlights with high and low beams			
Parking lights			
Double brake and tail lights	•	•	
Turn signals with flashing hazard light function			
Halogen work lights (2 front and 2 rear)			
Contronic monitoring system			
Monitoring and logging of machine data	•	•	
Contronic display	•	•	
Fuel consumption	•	•	
Diesel Exhaust Fluid/AdBlue consumption	•	•	
Ambient temperature	•	•	
Clock	•	•	
Test function for warning and indicator lights	•	•	
Brake test	•	•	
Test function, sound level at max fan speed	•	•	
Warning and indicator lights:			
Battery charging	•	•	
Parking brake			
Warning and display message:			
Regeneration			
Engine coolant temperature			
Charge-air temperature			
Engine oil temperature			
Engine oil pressure			
Transmission oil temperature			
Transmission oil pressure			
Hydraulic oil temperature			
Brake pressure	•	•	
Parking brake applied			
Brake charging			
Overspeed at direction change			
Axle oil temperature			
Steering pressure			
Crankcase pressure			
Attachment lock open			
Safety Belt Warning			
Level warnings:			
Fuel level			
Diesel Exhaust Fluid/AdBlue level			
Engine oil level	•	•	
Engine coolant level			
Transmission oil level			
Hydraulic oil level			
Washer fluid level			
Engine torque reduction in case of malfunction indication:			
High engine coolant temperature			
High engine oil temperature	•	•	
Low engine oil pressure			
High crankcase pressure			
High charge-air temperature			
Engine shutdown to idle in case of malfunction indication:			
High transmission oil temperature	•	•	
Slip in transmission clutches			
Keypad, background lit	•	•	
Start interlock when gear is engaged	•	•	

STANDARD EQUIPMENT			
	L110H	L120H	
Hydraulic system			
Main valve, double acting 2-spool with hydraulic pilots	•	•	
Variable displacement axial piston pumps (3) for:			
1 Working hydraulics, Pilot hydraulics and Brake system	•	•	
2 Working hydraulics, Pilot hydraulics, Steering and Brake system			
3 Cooling fan and Brake system			
Electro-hydraulic servo controls	•	•	
Electronic hydraulic lever lock	•	•	
Automatic boom kick-out	•	•	
Automatic bucket positioner	•	•	
Double-acting hydraulic cylinders	•	•	
Indicator glass for hydraulic oil level	•	•	
Hydraulic oil cooler	•	•	
Brake system			
Dual brake circuits	•	•	
Dual brake pedals	•	•	
Secondary brake system	•	•	
Parking brake, electro-hydraulic	•	•	
Brake wear indicators	•	•	
Cab			
ROPS (ISO 3471), FOPS (ISO 3449)	•	•	
Single key kit door/start	•	•	
Acoustic inner lining	•	•	
Cigarette lighter, 24 V power outlet	•	•	
Lockable door	•	•	
Cab heating with fresh air inlet and defroster	•	•	
Fresh air inlet with two filters	•	•	
Automatic heat control	•	•	
Floor mat	•	•	
Dual interior lights	•	•	
Interior rear-view mirrors	•	•	
Dual exterior rear-view mirrors	•	•	
Sliding window, right side	•	•	
Tinted windshield glass	•	•	
Retractable seatbelt (SAE J386)	•	•	
Adjustable steering wheel	•	•	
Storage compartment	•	•	
Document pocket	•	•	
Sun visor	•	•	
Beverage holder	•	•	
Windshield washer front and rear	•	•	
Windshield wipers front and rear	•	•	
Interval function for front and rear wipers	•	•	
Service and maintenance			
Engine oil remote drain and fill	•	•	
Transmission oil remote drain and fill	•	•	
Lubrication manifolds, ground accessible	•	•	
Pressure check connections: transmission and hydraulic, quick-connects	•	•	
Quick-fit hydraulic oil fill	•	•	
Tool box, lockable	•	•	
External equipment			
Orange hand rails	•	•	
Fenders, front and rear	•	•	
Viscous cab mounts	•	•	
Rubber engine and transmission mounts	•	•	
Frame, joint lock	•	•	
Vandalism lock prepared for			
Engine compartment	•	•	
Radiator grille			
Lifting eyes	•	•	
Tie-down eyes	•	•	
Fabricated counterweight	•	•	
Counterweight, pre-drilled for optional guards	•	•	

Equipment

OPTIONAL EQUIPMENT	L110H	L120H
Engine		
Air pre-cleaner, cyclone type	•	•
Air pre-cleaner, oil-bath type	•	•
Air pre-cleaner, turbo type	•	•
Engine auto shutdown	•	•
Engine delayed shutdown	•	•
Engine block heater	•	•
Fuel fill strainer	•	•
Fuel heater	•	•
Hand throttle control	•	•
Max. fan speed, hot climate	•	•
Radiator, corrosion-protected	•	•
Reversible cooling fan	•	•
Reversible cooling fan and axle oil cooler	•	•
Tires		
23.5 R25	•	•
750/65 R25	•	•
Electrical system		
Anti-theft device	•	•
Alarm kit, anti-theft function in WECU	•	•
Battery disconnect switch, additional in cab	•	•
Emergency stop	•	•
Locking device, Tag out Lock out	•	•
Headlights, assym. left	•	•
License plate holder, lighting	•	•
Rear view camera, monitor	•	•
Rear view mirrors, el.adjusted and heated	•	•
Rear view mirrors, long arm right	•	•
Rear view mirrors, el.adjusted and heated, long arm right	•	•
Reduced function working lights, reverse gear activated	•	•
Reverse alarm, audible	•	•
Reverse alarm, white noise	•	•
Reverse warning light, strobe lighting	•	•
Seatbelt indicator, external	•	•
Shortened headlight support brackets	•	•
Side marker lamps	•	•
Warning beacon LED	•	•
Warning beacon LED automatic	•	•
LED Head Light	•	•
LED tail light	•	•
LED working lights, attachments	•	•
LED working lights on cab, front and rear	•	•
LED working lights on cab, front, 2 alt. 4 LED lamps	•	•
LED working lights on cab, rear, 2 alt. 4 LED lamps	•	•
LED working lights, rear in grille, 2 LED lamps	•	•
LED working lights, front above head lamps, 2 LED lamps	•	•
LED work lights, side on cab, 4 LED lamps	•	•
LED light packages	•	•
Working lights halogen, attachments	•	•
Working lights on cab halogen, front and rear	•	•
Working lights on cab halogen, rear	•	•
Electrical distribution unit 24 volt	•	•
Alternator 120 amp, heavy-duty	•	•
Load Assist	•	•
Radar detect system	•	•
Forward camera, colour	•	•
Parking brake alarm, audible for air susp seats	•	•
Jump start connector, NATO-Type	•	•
Max Boom height	•	•
Can Bus Interface	•	•
Delayed Engine Shutdown	•	•
Co Pilot available	•	•
Rearview camera in Co pilot	•	•
OnBoard Weighing	•	•
Tire pressure monitoring	•	•
MAP	•	•

OPTIONAL EQUIPMENT	L110H	L120H
Hydraulic system		
Boom suspension system	•	•
Separate attachment locking	•	•
Arctic kit, attachment locking hoses	•	•
Boom cylinder hose and tube guards	•	•
Hydraulic fluid, biodegradable, Volvo	•	•
Hydraulic fluid, fire-resistant	•	•
Hydraulic fluid, for hot climate	•	•
Hydraulic 3rd function	•	•
hydraulic 3rd-4th function	•	•
Hydraulic constant flow control with detent for 3rd function	•	•
Single lever control, hydraulics 2 functions	•	•
Single lever control, hydraulics 3 functions	•	•
Single lever control, hydraulics 4 functions	•	•
Brake system		
Oil cooler and filter front & rear axle	•	•
OptiShift transmission with Lock-up RBB	•	•
Diff lock front 100%, Limited Slip rear	•	•
Agri power-shift / lock-up 1 -> 4	•	•
Speed limiter	•	•
Stainless steel, brake lines	•	•
Cab		
Anchorage for Operator's manual	•	•
Automatic Climate Control, ACC	•	•
ACC control panel, with Fahrenheit scale	•	•
Asbestos dust protection filter	•	•
Ashtray	•	•
Cab air pre-cleaner, cyclone type	•	•
Carbon filter	•	•
Cover plate, under cab	•	•
Lunch box holder	•	•
Volvo Armrest, operator's seat, left	•	•
Operator's seat, Volvo air susp, heavy-duty, high back, heated	•	•
Operator's seat, (air seat std) 2-point seat belt	•	•
Operator's seat, (air seat std) 3-point seat belt	•	•
Operator's seat, Premium Comfort ISRI	•	•
Operator's seat, Premium Comfort ISRI 3-point seat belt	•	•
Radio installation kit incl. 12 volt outlet, left side	•	•
Radio installation kit incl. 12 volt outlet, right side	•	•
Radio (with AUX, Bluetooth and USB connection)	•	•
DAB Radio	•	•
Subwoofer	•	•
Steering wheel knob	•	•
Sun blinds, rear windows	•	•
Sun blinds, side windows	•	•
Timer cab heating	•	•
Window, sliding, door	•	•
Universal door/ignition key	•	•
Remote door opener	•	•
Forward view mirror	•	•
Cab heater power outlet 240V	•	•
Cab, Hot applications. Roof, steel	•	•
Fire extinguisher cab	•	•
Outside steel protection cab	•	•
Rear view mirrors long arm, cab	•	•
Reinforced windshield, flat	•	•
Service and maintenance		
Automatic lubrication system	•	•
Automatic lubrication system for long boom	•	•
Grease nipple guards	•	•
Oil sampling valve	•	•
Refill pump for grease to lube system	•	•
Tool kit	•	•
Wheel nut wrench kit	•	•
CareTrack, GSM, GSM/Satellite	•	•
Telematics, Subscription	•	•

OPTIONAL EQUIPMENT		
	L110H	L120H
Protective Equipment		
Belly guard front	•	•
Belly guard rear	•	•
Cover plate, heavy-duty, front frame	•	•
Cover plate, rear frame	•	•
Cover plate, front/rear axle	•	•
Cab roof, heavy-duty	•	•
Guards for front headlights	•	•
Guards for radiator grill	•	•
Guards for tail lights	•	•
Windows, side and rear guards	•	•
Windshield guard	•	•
Wheel/axle seal guards	•	•
Corrosion protection, painting of machine	•	•
Corrosion protection, painting of attachment bracket	•	•
Bucket Teeth protection	•	•
Other Equipment		
CE-marking	•	•
Comfort Drive Control (CDC)	•	•
Counterweight, logging	•	•
Counterweight, signal painted, chevrons	•	•
Secondary steering with automatic test function	•	•
Sound decal, EU	•	•
Sound decal, USA	•	•
Reflecting stickers (decals), machine contour	•	•
Reflecting stickers (stripes), machine contour Cab	•	•
Option for machines without dinitrol	•	•
Noise reduction kit, exterior	•	•
Sign, slow moving vehicle	•	•
Sign, 50 km/h	•	•

OPTIONAL EQUIPMENT		
	L110H	L120H
External equipment		
Cab ladder, rubber-suspended	•	•
Deleted front mudguards & wideners rear	•	•
Handles on counterweight	•	•
Fire suppression system	•	•
Mudguards, full cover, rear for 80-series tires	•	•
Mudguards, full cover, rear for 65-series tires	•	•
Long boom	•	•
Tow hitch	•	•
Attachments		
Buckets:		
Rock straight or spade nose		
General purpose	•	•
Re-handling		
Light material		
Wear parts:		
Bolt-on and weld-on bucket teeth	•	•
Segments		
Cutting edge in three sections, bolt-on		
Fork equipment	•	•
Material handling arm	•	•
Log grapples	•	•

SELECTION OF VOLVO OPTIONAL EQUIPMENT

Additional auxiliary hydraulics



Fire suppression system



Rehandling counterweight



External axle oil cooling



LED light packages



Long boom



Not all products are available in all markets. Under our policy of continuous improvement, we reserve the right to change specifications and design without prior notice. The illustrations do not necessarily show the standard version of the machine.

VOLVO

Volvo Construction Equipment

volvoce.com