

V O L V O



Volvo Excavators for demolition

EC300E STRAIGHT BOOM, EC380E STRAIGHT BOOM

Volvo Construction Equipment



Welcome to our world

Welcome to a world of industry leading machinery. A world where imagination, hard work and technological innovation will lead the way towards developing a future which is cleaner, smarter, and more connected. A world supported by the enduring values of the Volvo Group. A world of stability, sustainability and innovation. A world which we put our customers at the heart of.

Welcome to the world of Volvo Construction Equipment – we think you're going to like it here.

Working harder, working smarter

For over 180 years Volvo has been a pioneer in the design and manufacture of machines which set the standard for efficiency, performance and uptime. Across our range of excavators, wheel loaders and haulers, our reputation for engineering excellence is unrivalled, which means whatever your operation or application, we can provide a total fleet solution to help you succeed.

Building on our proud history, the Volvo Concept Lab continues to create cutting-edge ideas and innovative concepts, to ensure we offer customers machines which work harder and smarter long into the future.



Solutions for you

Our industry leading machines are just the start of your relationship with Volvo. As your partner, we have developed an extensive range of additional solutions to help you improve uptime, boost productivity and reduce costs.

Designed for your business

Structured across nine blocks, our portfolio of products and services are designed to complement your machine's performance and boost your profitability. Simply put, we offer some of the best guarantees, warranties and technological solutions in the industry today.

There when you need us

Whether you're buying new or used, our global network of dealers and technicians offer around-the-clock support, including machine monitoring and world-class parts availability. It's the basis of everything offered by Volvo Services, so you can be confident we've got you covered right from the start.



BUILDING TOMORROW





Made for demolition

Specialist tasks require specialist equipment, which is why Volvo offer a range of tailor-made machinery, specially adapted to meet the unique requirements of the segment you are working in. Two such machines are the EC300E Straight Boom and EC380E Straight Boom – configured to deliver the highest levels of performance and safety in demolition applications, all while retaining the quality and comfort you would expect from their standard counterparts.

The perfect choice in demolition applications

With a significant height advantage over standard models, the custom-built straight boom excavators offer a clear view of the jobsite, and ultimate protection against falling debris. Providing outstanding reach, stability and lifting capabilities, along with a durable design and protected operator environment, the EC300E Straight Boom and EC380E Straight Boom models are the perfect choice when working in demolition applications.

More than machines

As with all Volvo products you can trust in the full support and back-up of your Volvo dealer, combined with a comprehensive portfolio of Volvo aftermarket solutions, for the lifetime of your machine.

Configured for success

High visibility, protected cab

Industry renowned Volvo Care Cab comfort combines additional features to enhance safety and visibility

- Frame-mounted Falling Object Guards
- Wide opening of front guard for easy cleaning
- Roll Over Protection Structure, meeting ISO 12117-2:2008 requirements
- P5A grade glazing on single-piece front window and roof window, offering high impact protection which meets EN356 standards
- Washer and wiper on windshield and roof window

LED lights

See more, do more

Standard LED lights on the cab, platform, counterweight and boom

Reversible cooling fan

Protects vital machine components from damage through overheating

Reversible functionality enables selfcleaning, reducing maintenance requirements and machine downtime

Heavy counterweight

Outstanding stability, yet easy to transport

A hydraulically removable counterweight enables easy transportation (EC380E Straight Boom)





Specialist work equipment

Fully equipped and ready for action

- 7.0 m / 23'0" straight boom
- Dedicated arms
- X1 and X3 auxiliary piping
- Quick fit and oil drain line
- Water lines for dust suppression system

Dust suppression system

The unique Volvo system captures dust, removing the need for a separate truck for pumping water

- 30 l / 7.9 gal per minute water pump
- Four nozzles fitted on the arm create a fine mist which encapsulates the dust
 - Selectable Auto/Manual mode. In Auto mode, the water is only sprayed when the attachment is operating
 - Can also be used for cleaning the machine, with a high-pressure water gun mounted behind the cab

Heavy duty protection

Ultimate protection from damage and debris, securing uptime and long-term performance

- Boom cylinder protection
- Bucket cylinder protection
- Heavy-duty side doors with screens and louvers
- Slew ring cover
- Side Impact Protection Structure (SIPS): choice of fixed cab entrance and thicker SIPS or the new foldable cab entrance and narrow SIPS to facilitate transportation (EC380E Straight Boom)
 - Heavy-Duty or eXtreme-Duty undercover
 - Heavy-Duty belly cover
 - Full track guard

Take a closer look

Hydraulically removable counterweight (EC380E Straight boom)



High visibility cab



Dust Suppression System - Selectable Auto/Manual mode



LED lighting



Heavy duty side doors



Reversible cooling fan



Volvo EC300E Straight Boom in detail

Engine

The next-generation Volvo diesel engine uses Volvo Advanced Combustion Technology (V-ACT) to deliver lower emissions, superior performance and fuel efficiency. The engine uses precise, high-pressure fuel injectors, turbo charger and intercooler, and electronic engine controls to optimize machine performance.

Engine	Volvo	D8M
Max power at	r/min (r/s)	1,600 (26.7)
Net, ISO 9249/SAE J1349	kW (hp)	188 (252)
Gross, ISO 14396/SAE J1995	kW (hp)	189 (253)
Max torque	Nm (ft lbf)	1,290 (951)
at engine speed	r/min (r/s)	1,400 (23.3)
No. of cylinders		6
Displacement	l (in ³)	7.7 (470)
Bore	mm (in)	110 (4.33)
Stroke	mm (in)	135 (5.3)

Electrical System

High-capacity electrical system that is well protected. Waterproof doublelock harness plugs are used to secure corrosion-free connections. The main relays and solenoid valves are shielded to prevent damage. The master switch is standard.

Voltage	V	24
Batteries	V	2 x 12
Battery capacity	Ah	170
Alternator	V/A	28 / 80
Start motor	V - kW	24 - 5.5

Undercarriage

The undercarriage has a robust X-shaped frame. Greased and sealed track chains are standard.

Track shoes		2 x 50
Link pitch	mm (in)	203.2 (7.9)
Shoe width, triple grouser	mm (in)	600 / 700 / 800 / 900 (24 / 28 / 32 / 36)
Shoe width, triple grouser (HD)	mm (in)	600 (24)
Shoe width, double grouser	mm (in)	600 / 700 (24 / 28)
Bottom rollers		2 x 9
Top rollers		2 x 2

Cab

The operator's cab has easy access via a wide door opening. The cab is supported on hydraulic dampening mounts to reduce shock and vibration levels. These along with sound absorbing lining provide low noise levels. The cab has excellent all-round visibility. The front windshield can easily slide up into the ceiling, and the lower front glass can be removed and stored in the side door.

Refrigerant of the type R134a is used when this machine is equipped with air conditioning. Contains fluorinated greenhouse gas R134a, Global Warming Potential 1.430 t CO₂-eq.

Swing System

The swing system uses an axial piston motors, driving a planetary gearbox for maximum torque. An automatic holding brake and antirebound valve are standard.

Max. slew speed	r/min	11
Max. slew torque	kNm (ft lbf)	114.8 (84,655)

Travel System

Each track is powered by an automatic two-speed shift travel motor. The track brakes are multi-disc, spring-applied and hydraulic released. The travel motor, brake and planetary gears are well protected within the track frame.

Max. drawbar pull	kN (lbf)	248 (55,663)
Max. travel speed (low)	km/h (mi/h)	3.6 (2.2)
Max. travel speed (high)	km/h (mi/h)	5.4 (3.4)
Gradeability	°	35

Hydraulic system

The hydraulic system, also known as the "Automatic Sensing Work Mode," is designed for high-productivity, high-digging capacity, high-maneuvering precision and excellent fuel economy. The summation system, boom, arm and swing priority along with boom, arm and bucket regeneration provides optimum performance.

Main pump, Type 2 x Variable displacement axial piston pumps

Maximum flow	l/min (gal/min)	2 x 276 (2 x 72.9)
--------------	-----------------	--------------------

Pilot pump, Type Gear Pump

Maximum flow	l/min (gal/min)	20.3 (5.4)
--------------	-----------------	------------

Max. pressure

Implement	MPa (psi)	33.3 / 36.3 (4,830 / 5,265)
Travel circuit	MPa (psi)	36.3 (5,265)
Slew circuit	MPa (psi)	28.9 (4,192)
Pilot circuit	MPa (psi)	3.9 (566)

Hydraulic Motors

Travel: Variable displacement axial piston motor with mechanical brake.

Slew: Fixed displacement axial piston motor with mechanical brake.

Hydraulic Cylinders

Boom		2
Bore x Stroke	ø x mm (ø x in)	140 x 1,480 (5.5 x 58.3)
Arm		1
Bore x Stroke	ø x mm (ø x in)	150 x 1,745 (5.9 x 68.7)
Bucket		1
Bore x Stroke	ø x mm (ø x in)	140 x 1,140 (5.5 x 44.9)

Service Refill

Fuel tank	l (gal)	472 (124.7)
DEF/AdBlue® tank	l (gal)	50 (13)
Hydraulic system, total	l (gal)	385 (101.7)
Hydraulic tank	l (gal)	215 (56.8)
Engine oil	l (gal)	30 (7.9)
Engine coolant	l (gal)	44 (12)
Slew reduction unit	l (gal)	6.1 (1.6)
Travel reduction unit	l (gal)	2 x 6 (2 x 1.6)

Sound Level

Sound pressure level in cab according to ISO 6396

L _{pA}	dB	70
-----------------	----	----

External sound level according to ISO 6395 and EU Noise Directive 2000/14/EC

L _{WA}	dB	104
-----------------	----	-----

Volvo EC380E Straight Boom in detail

Engine

The latest generation, Volvo engine Tier 4f emissions certified diesel engine fully meets the demands of the latest, emissions regulations. Featuring Volvo Advanced Combustion Technology (V-ACT), it is designed to deliver superior performance and fuel efficiency. The engine uses precise, highpressure fuel injectors, turbo charger and air-to-air intercooler, and electronic engine controls to optimize machine performance.

Air Filter: 3-stage with precleaner.

Automatic Idling System: Reduces engine speed to idle when the levers and pedals are not activated resulting in less fuel consumption and low cab noise levels.

Engine	Volvo	D13J
Max power at	r/min (r/s)	1,700 (28.3)
Net, ISO 9249/SAE J1349	kW (hp)	229 (307)
Gross, ISO 14396/SAE J1995	kW (hp)	230 (308)
Max torque	Nm (ft lbf)	1,692 (1,248)
at engine speed	r/min (r/s)	1,275 (21.3)
No. of cylinders		6
Displacement	l (in ³)	12.8 (781.1)
Bore	mm (in)	131 (5.2)
Stroke	mm (in)	158 (6.2)

Electrical System

High-capacity electrical system that is well protected. Waterproof double-lock harness plugs are used to secure corrosion-free connections. The main relays and solenoid valves are shielded to prevent damage. The master switch is standard. Contronics provides advanced monitoring of machine functions and important diagnostic information.

Voltage	V	24
Batteries	V	2 x 12
Battery capacity	Ah	200
Alternator	V/A	28/80

Undercarriage

The undercarriage has a robust X-shaped frame. Greased and sealed track chains are standard.

Track shoes		2 x 50
Link pitch	mm (in)	215.9 (8.5)
Shoe width, triple grouser	mm (in)	600/600HD/700/800/900 (24/24HD/28/32/36)
Shoe width, double grouser	mm (in)	600 (23.6)
Bottom rollers		2 x 9
Top rollers		2 x 2

Cab

The operator's cab has easy access via a wide door opening. The cab is supported on hydraulic dampening mounts to reduce shock and vibration levels. These along with sound absorbing lining provide low noise levels. The cab has excellent all-round visibility. The front windshield can easily slide up into the ceiling, and the lower front glass can be removed and stored in the side door.

Integrated airconditioning and heating system: The pressurized and filtered cab air is supplied by an automatically controlled fan. The air is distributed throughout the cab from 14 vents.

Ergonomic operator's seat: The adjustable seat and joystick console move independently to accommodate the operator. The seat has 12 different adjustments plus a seat belt for the operator's comfort and safety.

Refrigerant of the type R134a is used when this machine is equipped with air conditioning. Contains fluorinated greenhouse gas R134a, Global Warming Potential 1430 CO₂-eq.

Swing System

The swing system uses an axial piston motors, driving a planetary gearbox for maximum torque. An automatic holding brake and antirebound valve are standard.

Max. slew speed	r/min	10.2
Max. slew torque	kNm (ft lbf)	130.5 (96,252)

Travel System

Each track is powered by an automatic two-speed shift travel motor. The track brakes are multi-disc, spring-applied and hydraulic released. The travel motor, brake and planetary gears are well protected within the track frame.

Max. drawbar pull	kN (lbf)	276.5 (62,159.7)
Max. travel speed (low)	km/h (mi/h)	3.4 (2.1)
Max. travel speed (high)	km/h (mi/h)	5.3 (3.3)
Gradeability	°	35

Hydraulic system

The new electro-hydraulic system and new MCV (main control valve) use intelligent technology to control on-demand flow for highproductivity, high-digging capacity and excellent fuel consumption.

The following important functions are included in the system for optimum performance:

Summation system: Combines the flow of both hydraulic pumps to ensure quick cycle times and high productivity.

Boom priority: Gives priority to the boom operation for faster raising when loading or performing deep excavations.

Arm priority: Gives priority to the arm operation for faster cycle times in leveling and for increased bucket filling when digging.

Swing priority: Gives priority to swing functions for faster simultaneous operations.

Regeneration system: Prevents cavitation and provides flow to other movements during simultaneous operations for maximum productivity.

Power boost: All digging and lifting forces are increased.

Holding valves: Boom and arm holding valves prevent the digging equipment from creeping.

Main pump, Type 2 x variable displacement axial piston pumps

Maximum flow	l/min (gal/min)	2 x 300 (2 x 79.3)
--------------	-----------------	--------------------

Pilot pump, Type Gear pump

Maximum flow	l/min (gal/min)	32.6 (8.6)
--------------	-----------------	------------

Max. pressure

Implement	MPa (psi)	32.4 / 35.3 (4,699 / 5,120)
Travel circuit	MPa (psi)	35.3 (5,119.8)
Slew circuit	MPa (psi)	27.9 (4,046.6)
Pilot circuit	MPa (psi)	3.9 (565.6)

Hydraulic Motors

Travel: Variable displacement axial piston motor with mechanical brake.

Slew: Fixed displacement axial piston motor with mechanical brake

Hydraulic Cylinders

Boom		2
Bore x Stroke	ø x mm (ø x in)	160 x 1 530 (6.3 x 60.2)
Arm		1
Bore x Stroke	ø x mm (ø x in)	175 x 1 700 (6.9 x 66.9)
Bucket		1
Bore x Stroke	ø x mm (ø x in)	145 x 1 285 (5.7 x 50.6)

Service Refill

Fuel tank	l (gal)	620 (163.8)
DEF/AdBlue® tank	l (gal)	62.5 (16.5)
Hydraulic system, total	l (gal)	500 (132.1)
Hydraulic tank	l (gal)	225 (59.4)
Engine oil	l (gal)	42 (11.1)
Engine coolant	l (gal)	60 (15.9)
Slew reduction unit	l (gal)	6.5 (1.7)
Travel reduction unit	l (gal)	2 x 6.8 (2 x 1.8)

Sound Level

Sound level in cab according to ISO 6396

L _{pA}	dB	71
-----------------	----	----

External sound level according to ISO 6395 and EU Noise Directive (2000/14/EC) and 474-1:2006 +A1:2009

L _{WA}	dB	105
-----------------	----	-----

Specifications

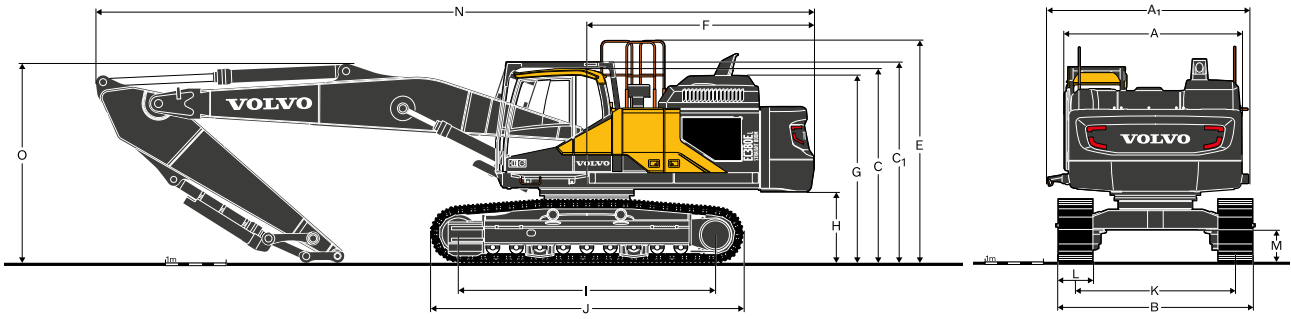

DIMENSIONS

Description	Unit		EC300EL		EC380EL	
	m (ft in)		7.0 (23'0")		7.0 (23'0")	
Boom						
Arm	m	ft in	3.05	10'0"	3.9	12'10"
A. Overall width of upper structure	mm	ft in	2,890	9'6"	2,990	9'10"
A ₁ . Overall width of upper frame - SIPS including cab entrance**	mm	ft in	3,086	10'1"	3,437	11'3"
B. Overall width	mm	ft in	3,190	10'6"	3,340	10'11"
C. Overall height of cab	mm	ft in	3,110	10'2"	3,220	10'7"
C ₁ . Overall height of FOG	mm	ft in	3,220	10'7"	3,330	10'11"
D. Overall height of engine hood	mm	ft in	3,010	9'11"	3,110	10'2"
E. Overall height of diffuser	mm	ft in	3,210	10'6"	3,468	11'5"
F. Overall height of guardrail	mm	ft in	3,570	11'9"	3,687	12'1"
G. Tail swing radius	mm	ft in	3,120	10'3"	3,760	12'4"
G'. Tail swing radius, with removed counterweight	mm	ft in	-	-	3,582	11'9"
H. Counterweight clearance*	mm	ft in	1,105	3'8"	1,150	3'9"
I. Tumbler length	mm	ft in	4,015	13'2"	4,240	13'11"
J. Track length	mm	ft in	4,865	15'12"	5,180	17'0"
K. Track gauge	mm	ft in	2,590	8'6"	2,740	9'0"
L. Shoe width	mm	ft in	600	1'12"	600	2'0"
M. Min. ground clearance*	mm	ft in	475	1'7"	500	1'8"
N. Overall length	mm	ft in	11,340	37'2"	11,895	39'0"
O. Overall height of boom	mm	ft in	2,954	9'8"	3,300	10'10"

*Without shoe grouser

**Cab entrance only available for EC380EL

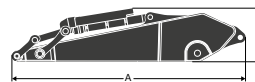
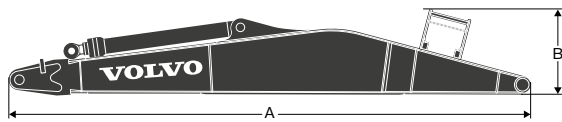

DIMENSIONS

EC300E

Description	Unit		Straight		Description	Unit		Straight	
	m (ft in)		7.0 (23'0")			m (ft in)		3.05 HD (10'0")	
Boom					Arm				
A	mm	ft in	7,225	23'8"	A	mm	ft in	4,145	13'7"
B	mm	ft in	1,059	3'6"	B	mm	ft in	1,010	3'4"
Width	mm	ft in	766	2'6"	Width	mm	ft in	560	1'10"
Weight	kg	lb	3,178	7,006	Weight	kg	lb	1,969	4,341

EC380E

Description	Unit		Straight		Description	Unit		Straight	
	m (ft in)		7.0 (23'0")			m (ft in)		3.9 HD (12'0")	
Boom					Arm				
A	mm	ft in	7,260	23'10"	A	mm	ft in	5,080	16'8"
B	mm	ft in	1,240	4'1"	B	mm	ft in	1,145	3'9"
Width	mm	ft in	820	2'8"	Width	mm	ft in	560	1'10"
Weight	kg	lb	3,950	8,710	Weight	kg	lb	2,714	5,980

Specifications

COUNTERWEIGHT - EC380EL Straight Boom - 10,000 kg (22,050 lb)

A. Length	mm	ft in	2,989	9'10"
B. Height	mm	ft in	1,441	4,9"
C. Width	mm	ft in	904	3'0"
Weight	kg	lb	9,021	19,890

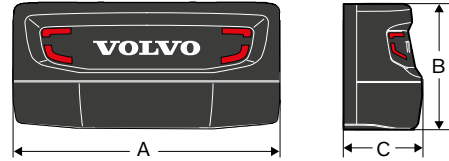

TOOL WEIGHT GUIDELINE FOR STRAIGHT BOOM

Allowable tool weight at arm end w/o quick fit

Model			EC300E		EC380E	
Lower frame			L		L	
Boom	m (ft in)		7.0 (23'0")		7.0 (23'0")	
Arm	m	ft in	3.05	11'6"	3.9	12'10"
CWT	t	lb	6.9	15,210	10.0	22,046
Breaker	kg	lb	2,400	5,291	3,500	7,716
Crusher	kg	lb	3,100	6,834	4,600	10,141
Multiprocessor	kg	lb	2,700	5,952	4,000	8,818
Shear	kg	lb	2,400	5,291	3,500	7,716
Sort & Grab	kg	lb	1,700	3,748	2,600	5,732

Boom mount attachment

Model			EC300E		EC380E	
Lower frame			L		L	
Boom	m (ft in)		7.0 (23'0")		7.0 (23'0")	
CWT	t	lb	6.9	15,210	10.0	22,046
Shear	kg	lb	4,900	10,803	7,900	17,417

GROUND PRESSURE

EC300EL

Description	Shoe width		Operating weight		Ground pressure	
	mm	in	kg	lb	kPa	psi
Triple grouser	600	24	34,327	75,519	65.0	9.4
	700	28	34,910	76,802	56.7	8.2
	800	32	35,286	77,629	50.2	7.3
	900	36	35,658	78,448	45.0	6.5
Triple grouser(HD)	600	24	34,482	75,860	65.3	9.5
Double grouser	600	24	34,643	76,215	65.6	9.5
	700	28	35,045	77,099	56.9	8.3

EC300E with L undercarriage, 7.0 m / 23'0" boom, 3.05 m / 10'0" HD arm, 1,209 kg / 2,665 lb bucket, 6,900 kg / 15,212 lb counterweight

EC380EL

Description	Shoe width		Operating weight		Ground pressure	
	mm	in	kg	lb	kPa	psi
Triple grouser	600	24	45,195	99,640	80.8	11.7
	700	28	45,637	100,610	70.0	10.1
	800	32	46,079	101,590	61.8	9.0
	900	36	46,521	102,560	55.5	8.0
Triple grouser(HD)	600	24	45,634	100,605	81.6	11.8
Double grouser	600	24	45,458	100,220	81.3	11.7

EC380E with LC undercarriage, 7.0 m / 23'0" boom, 3.9 m / 12'0" arm, 1,546 kg / 3,408 lb bucket, 10,000 kg / 22,046 lb counterweight

WORKING RANGES

Description	Unit	EC300EL		EC380EL	
Boom	m (ft in)	7.0 (23'0")		7.0 (23'0")	
Arm	m ft in	3.05	10'0"	3.9	12'10"
A. Max. digging reach	mm ft in	11,716	38'5"	12,565	41'3"
B. Max. digging reach on ground	mm ft in	11,536	37'10"	12,380	40'7"
C. Max. digging depth	mm ft in	6,110	20'1"	12,565	41'3"
D. Max. digging depth (2.44 m/8' level)	mm ft in	5,948	19'6"	6,705	22'0"
E. Max. vertical wall digging depth	mm ft in	4,863	15'11"	12,565	41'3"
F. Max. cutting height	mm ft in	13,117	43'0"	13,860	45'6"
G. Max. dumping height	mm ft in	9,881	32'5"	12,565	41'3"
H. Min. front slew radius	mm ft in	3,473	11'5"	3,760	12'4"

DIGGING FORCES WITH DIRECT FIT BUCKET

Breakout force - bucket	Normal	SAE J1179	kN	lb	165.0	37,093	198.0	44,510
	Power boost	SAE J1179	kN	lb	179.0	40,241	215.0	48,335
	Normal	ISO 6015	kN	lb	190.0	42,714	221.7	49,840
	Power boost	ISO 6015	kN	lb	207.0	46,535	242.7	54,560
Tearout force - dipper arm	Normal	SAE J1179	kN	lb	133.0	29,900	198.0	44,510
	Power boost	SAE J1179	kN	lb	144.0	32,372	215.0	48,335
	Normal	ISO 6015	kN	lb	136.0	30,574	221.7	49,840
	Power boost	ISO 6015	kN	lb	148.0	33,271	242.7	54,560

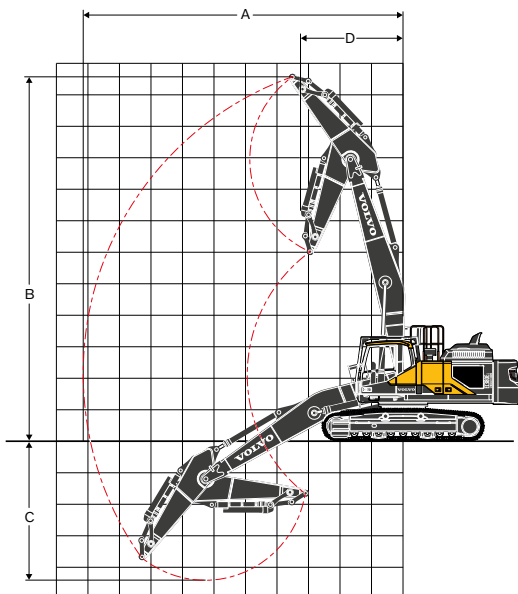
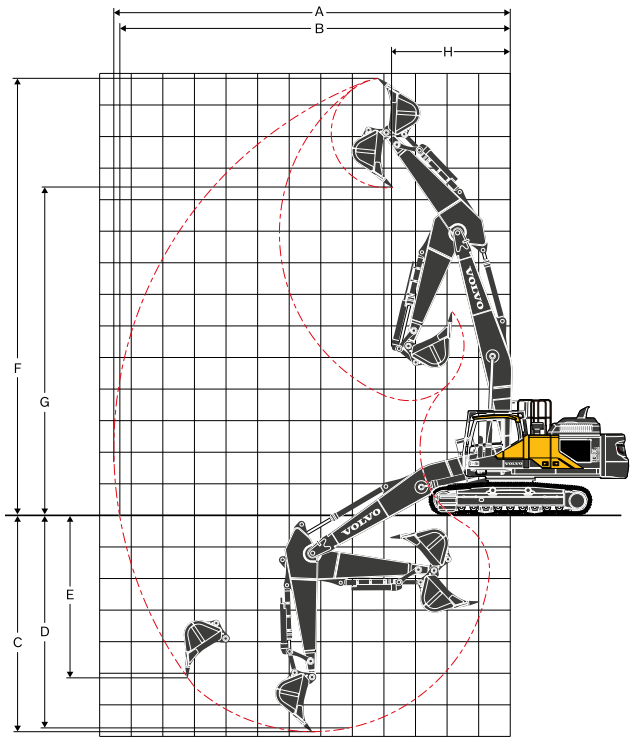

Description	Unit	EC300E		EC380E	
Boom	m (ft in)	7.0(23'0")		7.0(23'0")	
Arm	m ft in	3.05	10'0"	3.9	12'10"
A. Max. pin reach	mm ft in	10,097	33'2"	10,825	35'6"
B. Max. pin height	mm ft in	11,500	37'9"	12,140	39'10"
C. Max. pin depth	mm ft in	4,491	14'9"	5,095	16'9"
D. Min. front swing radius	mm ft in	3,191	10'6"	3,520	11'7"

Specifications

LIFTING CAPACITY EC300ELC

Lifting capacity at the arm end without bucket / with bucket cylinder protect

For lifting capacity including bucket, simply subtract actual weight of the direct fit bucket or the bucket with quick coupler from the following values.

	Lifting hook related to ground level	3.0 m, 10 ft		4.5 m, 15 ft		6.0 m, 20 ft		7.5 m, 25 ft		9.0 m, 30 ft		Max. Reach				
		Along UC	Across UC	Along UC	Across UC	Along UC	Across UC	Along UC	Across UC	Along UC	Across UC	Along UC	Across UC	max.		
Boom : 7.0 m (23'0") Arm : 3.05 m HD (10'0") Shoe : 600 mm (24") CWT : 6 900 kg (15,212lb)	10.5 m kg												*8,640	*8,640	5.3 m	
	35.0 ft lb												*19,790	*19,790	16.5 ft	
	9.0 m kg					*9,400	*9,400						*6,910	6,800	7.2 m	
	30.0 ft lb					*20,730	20,660						*15,470	*15,470	23.2 ft	
	7.5 m kg					*9,070	*9,070	*8,390	6,500				*6,180	5,120	8.4 m	
	25.0 ft lb					*20,090	*20,090	*18,350	13,920				*13,730	11,510	27.4 ft	
	6.0 m kg			*9,370	*9,370	*9,990	9,180	*8,540	6,340	7,210	4,550		*5,830	4,260	9.3 m	
	20.0 ft lb					*21,800	19,800	*18,570	13,650	*14,600	9,680		*12,900	9,490	30.2 ft	
	4.5 m kg					*10,900	8,570	*8,860	6,040	7,100	4,440		*5,700	3,770	9.8 m	
	15.0 ft lb			*31,430	28,760	*23,580	18,510	*19,220	13,030	15,250	9,540		*12,560	8,360	32.0 ft	
	3.0 m kg					*11,590	7,880	*9,150	5,690	6,910	4,270		*5,730	3,510	10.0 m	
	10.0 ft lb					*25,080	17,040	*19,830	12,270	14,860	9,180		*12,610	7,750	32.9 ft	
	1.5 m kg					*11,770	7,330	8,850	5,370	6,720	4,090		5,620	3,400	10.0 m	
	5.0 ft lb					*25,520	15,830	19,070	11,580	14,460	8,810		12,400	7,510	33.1 ft	
	0 m kg					*11,250	7,000	8,590	5,140	6,570	3,960		*5,710	3,450	9.9 m	
	0 ft lb					*24,420	15,100	18,510	11,080	14,160	8,530		*12,590	7,610	32.4 ft	
	-1.5 m kg			*12,000	10,560	*10,040	6,870	*8,000	5,030	*6,030	3,910		*5,100	3,670	9.5 m	
	-5.0 ft lb				*26,310	22,700	*21,790	14,810	*17,250	10,840	*12,730	8,450		*11,230	8,110	31.0 ft
	-3.0 m kg	*8,280	*8,280	*9,390	*9,390	*8,120	6,900	*6,380	5,040				*4,180	4,160	8.8 m	
	-10.0 ft lb	*18,310	*18,310	*20,420	*20,420	*17,510	14,880	*13,570	10,900				*9,140	*9,140	28.6 ft	
-4.5 m kg	*4,100	*4,100	*5,800	*5,800	*5,170	*5,170	*3,170	*3,170				*2,610	*2,610	7.7 m		
-15.0 ft lb	*8,770	*8,770	*12,350	*12,350	*10,840	*10,840						*5,520	*5,520	24.9 ft		
Boom : 7.0 m (23'0") Arm : 3.05 m HD (10'0") Shoe : 700 mm (28") CWT : 6 900 kg (15,212lb)	10.5 m kg												*8,640	*8,640	5.3 m	
	35.0 ft lb												*19,790	*19,790	16.4 ft	
	9.0 m kg					*9,400	*9,400						*6,910	6,900	7.2 m	
	30.0 ft lb					*20,730	*20,730						*15,470	*15,470	23.2 ft	
	7.5 m kg					*9,070	*9,070	*8,390	6,600				*6,180	5,210	8.4 m	
	25.0 ft lb					*20,090	*20,090	*18,350	14,130				*13,730	11,700	27.4 ft	
	6.0 m kg			*9,370	*9,370	*9,990	9,310	*8,540	6,440	7,340	4,630		*5,830	4,340	9.3 m	
	20.0 ft lb					*21,800	20,090	*18,570	13,860	*14,600	9,860		*12,900	9,670	30.2 ft	
	4.5 m kg					*10,900	8,700	*8,860	6,140	7,230	4,520		*5,700	3,850	9.8 m	
	15.0 ft lb			*31,430	29,180	*23,580	18,800	*19,220	13,240	15,530	9,710		*12,560	8,520	32.0 ft	
	3.0 m kg					*11,590	8,020	*9,150	5,790	7,040	4,350		*5,730	3,580	10.0 m	
	10.0 ft lb					*25,080	17,330	*19,830	12,490	15,150	9,360		*12,610	7,900	32.9 ft	
	1.5 m kg					*11,770	7,460	9,020	5,470	6,850	4,170		5,730	3,470	10.0 m	
	5.0 ft lb					*25,520	16,120	19,420	11,800	14,740	8,980		12,640	7,660	33.1 ft	
	0 m kg					*11,250	7,130	8,760	5,240	6,700	4,040		*5,710	3,520	9.9 m	
	0 ft lb					*24,420	15,380	18,870	11,300	14,440	8,710		*12,590	7,770	32.4 ft	
	-1.5 m kg			*12,000	10,750	*10,040	7,000	*8,000	5,130	*6,030	3,990		*5,100	3,750	9.5 m	
	-5.0 ft lb				*26,310	23,130	*21,790	15,100	*17,250	11,060	*12,730	8,620		*11,230	8,280	31.0 ft
	-3.0 m kg	*8,280	*8,280	*9,390	*9,390	*8,120	7,030	*6,380	5,140				*4,180	*4,180	8.8 m	
	-10.0 ft lb	*18,310	*18,310	*20,420	*20,420	*17,510	15,170	*13,570	11,110				*9,140	*9,140	28.6 ft	
-4.5 m kg	*4,100	*4,100	*5,800	*5,800	*5,170	*5,170	*3,170	*3,170				*2,610	*2,610	7.7 m		
-15.0 ft lb	*8,770	*8,770	*12,350	*12,350	*10,840	*10,840						*5,520	*5,520	24.9 ft		

Notes: 1. Machine in "Fine Mode-F" (Power Boost) for lifting capacities. 2. The above loads are in compliance with SAE J1,097 and ISO 10,567 Hydraulic Excavator Lifting Capacity Standards. 3. Rated loads do not exceed 87% of hydraulic lifting capacity or 75% of tipping load. 4. Rated loads marked with an asterisk (*) are limited by hydraulic capacity rather than tipping load.

LIFTING CAPACITY EC300ELC

Lifting capacity at the arm end without bucket / with bucket cylinder protect

For lifting capacity including bucket, simply subtract actual weight of the direct fit bucket or the bucket with quick coupler from the following values.

	Lifting hook related to ground level	3.0 m, 10 ft		4.5 m, 15 ft		6.0 m, 20 ft		7.5 m, 25 ft		9.0 m, 30 ft		Max. Reach			
		Along UC	Across UC	Along UC	Across UC	Along UC	Across UC	Along UC	Across UC	Along UC	Across UC	Along UC	Across UC	max.	
Boom : 7.0 m (23'0") Arm : 3.05 m HD (10'0") Shoe : 800 mm (24") CWT : 6 900 kg (15,212lb)	10.5 m kg												*8,640	*8,640	5.3 m
	35.0 ft lb												*19,790	*19,790	16.5 ft
	9.0 m kg					*9,400	*9,400						*6,910	*6,910	7.2 m
	30.0 ft lb					*20,730	*20,730						*15,470	*15,470	23.2 ft
	7.5 m kg					*9,070	*9,070	*8,390	6,660				*6,180	5,270	8.4 m
	25.0 ft lb					*20,090	*20,090	*18,350	14,270				*13,730	11,820	27.4 ft
	6.0 m kg			*9,370	*9,370	*9,990	9,400	*8,540	6,510	7,420	4,680		*5,830	4,390	9.3 m
	20.0 ft lb					*21,800	20,270	*18,570	14,000	*14,600	9,970		*12,900	9,780	30.2 ft
	4.5 m kg					*10,900	8,790	*8,860	6,210	7,310	4,580		*5,700	3,890	9.8 m
	15.0 ft lb			*31,430	29,460	*23,580	18,980	*19,220	13,380	15,720	9,820		*12,560	8,630	32.0 ft
	3.0 m kg					*11,590	8,100	*9,150	5,850	7,120	4,400		*5,730	3,620	10.1 m
	10.0 ft lb					*25,080	17,510	*19,830	12,630	15,330	9,470		*12,610	8,000	33.0 ft
	1.5 m kg					*11,770	7,550	9,120	5,530	6,930	4,220		5,810	3,520	10.1 m
	5.0 ft lb					*25,520	16,300	19,660	11,930	14,930	9,100		12,800	7,760	33.1 ft
	0 m kg					*11,250	7,220	8,870	5,300	6,790	4,090		*5,710	3,570	9.9 m
	0 ft lb					*24,420	15,570	19,100	11,440	14,630	8,820		*12,590	7,870	32.5 ft
	-1.5 m kg			*12,000	10,880	*10,040	7,090	*8,000	5,190	*6,030	4,040		*5,100	3,800	9.5 m
	-5.0 ft lb			*26,310	23,400	*21,790	15,280	*17,250	11,200	*12,730	8,740		*11,230	8,390	31.0 ft
	-3.0 m kg	*8,280	*8,280	*9,390	*9,390	*8,120	7,120	*6,380	5,210				*4,180	*4,180	8.8 m
	-10.0 ft lb	*18,310	*18,310	*20,420	*20,420	*17,510	15,360	*13,570	11,250				*9,140	*9,140	28.6 ft
-4.5 m kg	*4,100	*4,100	*5,800	*5,800	*5,170	*5,170	*3,170	*3,170				*2,610	*2,610	7.7 m	
-15.0 ft lb	*8,770	*8,770	*12,350	*12,350	*10,840	*10,840						*5,520	*5,520	25.0 ft	
Boom : 7.0 m (23'0") Arm : 3.05 m HD (10'0") Shoe : 900 mm (28") CWT : 6 900 kg (15,212lb)	10.5 m kg												*8,640	*8,640	5.3 m
	35.0 ft lb												*19,790	*19,790	16.5 ft
	9.0 m kg					*9,400	*9,400						*6,910	*6,910	7.2 m
	30.0 ft lb					*20,730	*20,730						*15,470	*15,470	23.2 ft
	7.5 m kg					*9,070	*9,070	*8,390	6,730				*6,180	5,320	8.4 m
	25.0 ft lb					*20,090	*20,090	*18,350	14,410				*13,730	11,950	27.4 ft
	6.0 m kg			*9,370	*9,370	*9,990	9,490	*8,540	6,570	*7,480	4,730		*5,830	4,440	9.3 m
	20.0 ft lb					*21,800	20,460	*18,570	14,140	*14,600	10,080		*12,900	9,890	30.2 ft
	4.5 m kg					*10,900	8,870	*8,860	6,270	7,400	4,630		*5,700	3,940	9.8 m
	15.0 ft lb			*31,430	29,730	*23,580	19,160	*19,220	13,520	15,900	9,940		*12,560	8,730	32.0 ft
	3.0 m kg					*11,590	8,190	*9,150	5,920	7,210	4,450		*5,730	3,670	10.1 m
	10.0 ft lb					*25,080	17,700	*19,830	12,770	15,510	9,580		*12,610	8,100	33.0 ft
	1.5 m kg					*11,770	7,630	*9,210	5,590	7,010	4,270		5,880	3,560	10.1 m
	5.0 ft lb					*25,520	16,480	19,880	12,070	15,110	9,210		12,960	7,860	33.1 ft
	0 m kg					*11,250	7,300	*8,870	5,370	6,870	4,140		*5,710	3,610	9.9 m
	0 ft lb					*24,420	15,750	*19,200	11,580	14,810	8,930		*12,590	7,970	32.5 ft
	-1.5 m kg			*12,000	11,010	*10,040	7,170	*8,000	5,250	*6,030	4,090		*5,100	3,840	9.5 m
	-5.0 ft lb			*26,310	23,670	*21,790	15,460	*17,250	11,340	*12,730	8,850		*11,230	8,490	31.0 ft
	-3.0 m kg	*8,280	*8,280	*9,390	*9,390	*8,120	7,200	*6,380	5,270				*4,180	*4,180	8.8 m
	-10.0 ft lb	*18,310	*18,310	*20,420	*20,420	*17,510	15,540	*13,570	11,390				*9,140	*9,140	28.6 ft
-4.5 m kg	*4,100	*4,100	*5,800	*5,800	*5,170	*5,170	*3,170	*3,170				*2,610	*2,610	7.7 m	
-15.0 ft lb	*8,770	*8,770	*12,350	*12,350	*10,840	*10,840						*5,520	*5,520	25.0 ft	

Notes: 1. Machine in "Fine Mode-F" (Power Boost) for lifting capacities. 2. The above loads are in compliance with SAE J1,097 and ISO 10,567 Hydraulic Excavator Lifting Capacity Standards. 3. Rated loads do not exceed 87% of hydraulic lifting capacity or 75% of tipping load. 4. Rated loads marked with an asterisk (*) are limited by hydraulic capacity rather than tipping load.

Specifications

LIFTING CAPACITY EC380ELC

Lifting capacity at the arm end without bucket / with bucket cylinder protect

For lifting capacity including bucket, simply subtract actual weight of the direct fit bucket or the bucket with quick coupler from the following values.

	Lifting hook related to ground level	3.0 m, 10 ft		4.5 m, 15 ft		6.0 m, 20 ft		7.5 m, 25 ft		9.0 m, 30 ft		10.5 m, 35 ft		Max. Reach		
		Along UC	Across UC	Along UC	Across UC	Along UC	Across UC	Along UC	Across UC	Along UC	Across UC	Along UC	Across UC	Along UC	Across UC	max.
Boom : 7.0m (23'0") Arm : 3.9m (12'10") Shoe : 600mm (24") CWT : 10,000kg (22,046lb)	10.5 m kg					*10,460	*10,460							*8,060	*8,060	6.8 m
	35.0 ft lb					*22,230	*22,230							*18,180	*18,180	21.6 ft
	9.0 m kg					*10,190	*10,190	*9,780	*9,780					*7,000	*7,000	8.3 m
	30.0 ft lb					*22,650	*22,650	*20,800	*20,800					*15,580	*15,580	26.9 ft
	7.5 m kg					*9,880	*9,880	*10,350	*10,350	*8,610	8,330			*6,480	*6,480	9.4 m
	25.0 ft lb					*21,890	*21,890	*22,700	*22,700	*16,950	*16,950			*14,340	*14,340	30.5 ft
	6.0 m kg			*9,550	*9,550	*10,770	*10,770	*10,770	*10,770	*9,570	8,270			*6,230	*6,230	10.1 m
	20.0 ft lb			*20,900	*20,900	*23,590	*23,590	*23,440	*23,440	*20,880	17,770			*13,750	*13,750	33.0 ft
	4.5 m kg			*17,860	*17,860	*13,740	*13,740	*11,370	10,720	*9,800	8,070	*6,760	6,230	*6,160	*6,160	10.6 m
	15.0 ft lb			*38,510	*38,510	*29,750	*29,750	*24,690	23,130	*21,320	17,380			*13,580	*13,580	34.6 ft
	3.0 m kg					*15,000	14,190	*11,990	10,260	*10,050	7,820	*8,540	6,130	*6,250	5,850	10.8 m
	10.0 ft lb			*44,290	*44,290	*32,460	30,640	*26,000	22,140	*21,810	16,850	*16,450	13,170	*13,760	12,920	35.4 ft
	1.5 m kg					*15,760	13,430	*12,370	9,830	*10,150	7,570	*8,340	6,010	*6,480	5,750	10.8 m
	5.0 ft lb			*32,670	*32,670	*34,140	28,990	*26,820	21,200	*21,980	16,310	*17,770	12,940	*14,290	12,680	35.5 ft
	0 m kg			*13,330	*13,330	*15,680	12,930	*12,300	9,500	*9,920	7,370	*7,720	5,920	*6,900	5,840	10.6 m
	0 ft lb			*31,240	*31,240	*34,010	27,880	*26,640	20,490	*21,430	15,890			*15,230	12,880	34.8 ft
	-1.5 m kg	*7,980	*7,980	*17,500	*17,500	*14,680	12,680	*11,590	9,300	*9,150	7,260			*6,950	6,160	10.2 m
	-5.0 ft lb	*18,180	*18,180	*40,470	*40,470	*31,830	27,330	*25,060	20,070	*19,650	15,660			*15,310	13,600	33.4 ft
	-3.0 m kg	*13,870	*13,870	*15,750	*15,750	*12,720	12,640	*10,050	9,270	*7,430	7,270			*6,130	*6,130	9.5 m
	-10.0 ft lb	*31,500	*31,500	*34,160	*34,160	*27,460	27,250	*21,570	20,000	*15,510	*15,510			*13,450	*13,450	31.1 ft
-4.5 m kg			*11,480	*11,480	*9,540	*9,540	*7,190	*7,190							8.5 m	
-15.0 ft lb			*24,600	*24,600	*20,320	*20,320	*14,950	*14,950							27.8 ft	
Boom : 7.0m (23'0") Arm : 3.9m (12'10") Shoe : 700mm (28") CWT : 10,000kg (22,046lb)	10.5 m kg					*10,460	*10,460							*8,060	*8,060	6.8 m
	35.0 ft lb					*22,230	*22,230							*18,180	*18,180	21.6 ft
	9.0 m kg					*10,190	*10,190	*9,780	*9,780					*7,000	*7,000	8.3 m
	30.0 ft lb					*22,650	*22,650	*20,800	*20,800					*15,580	*15,580	26.9 ft
	7.5 m kg					*9,880	*9,880	*10,350	*10,350	*8,610	8,400			*6,480	*6,480	9.4 m
	25.0 ft lb					*21,890	*21,890	*22,700	*22,700	*16,950	*16,950			*14,340	*14,340	30.5 ft
	6.0 m kg			*9,550	*9,550	*10,770	*10,770	*10,770	*10,770	*9,570	8,340			*6,230	*6,230	10.1 m
	20.0 ft lb			*20,900	*20,900	*23,590	*23,590	*23,440	*23,440	*20,880	17,910			*13,750	*13,750	33.0 ft
	4.5 m kg			*17,860	*17,860	*13,740	*13,740	*11,370	10,810	*9,800	8,140	*6,760	6,280	*6,160	*6,160	10.6 m
	15.0 ft lb			*38,510	*38,510	*29,750	*29,750	*24,690	23,300	*21,320	17,520			*13,580	*13,580	34.6 ft
	3.0 m kg					*15,000	14,300	*11,990	10,340	*10,050	7,880	*8,540	6,180	*6,250	5,910	10.8 m
	10.0 ft lb			*44,290	*44,290	*32,460	30,880	*26,000	22,310	*21,810	16,990	*16,450	13,290	*13,760	13,040	35.4 ft
	1.5 m kg					*15,760	13,540	*12,370	9,910	*10,150	7,630	*8,340	6,060	*6,480	5,800	10.8 m
	5.0 ft lb			*32,670	*32,670	*34,140	29,230	*26,820	21,380	*21,980	16,450	*17,770	13,060	*14,290	12,800	35.5 ft
	0 m kg			*13,330	*13,330	*15,680	13,030	*12,300	9,580	*9,920	7,430	*7,720	5,980	*6,900	5,890	10.6 m
	0 ft lb			*31,240	*31,240	*34,010	28,110	*26,640	20,660	*21,430	16,030			*15,230	13,000	34.8 ft
	-1.5 m kg	*7,980	*7,980	*17,500	*17,500	*14,680	12,780	*11,590	9,390	*9,150	7,320			*6,950	6,220	10.2 m
	-5.0 ft lb	*18,180	*18,180	*40,470	*40,470	*31,830	27,560	*25,060	20,250	*19,650	15,800			*15,310	13,730	33.4 ft
	-3.0 m kg	*13,870	*13,870	*15,750	*15,750	*12,720	*12,720	*10,050	9,350	*7,430	7,340			*6,130	*6,130	9.5 m
	-10.0 ft lb	*31,500	*31,500	*34,160	*34,160	*27,460	*27,460	*21,570	20,170	*15,510	*15,510			*13,450	*13,450	31.1 ft
-4.5 m kg			*11,480	*11,480	*9,540	*9,540	*7,190	*7,190							8.5 m	
-15.0 ft lb			*24,600	*24,600	*20,320	*20,320	*14,950	*14,950							27.8 ft	

Notes: 1. Machine in "Fine Mode-F" (Power Boost) for lifting capacities. 2. The above loads are in compliance with SAE J1,097 and ISO 10,567 Hydraulic Excavator Lifting Capacity Standards. 3. Rated loads do not exceed 87% of hydraulic lifting capacity or 75% of tipping load. 4. Rated loads marked with an asterisk (*) are limited by hydraulic capacity rather than tipping load.

LIFTING CAPACITY EC380ELC

Lifting capacity at the arm end without bucket / with bucket cylinder protect

For lifting capacity including bucket, simply subtract actual weight of the direct fit bucket or the bucket with quick coupler from the following values.

	Lifting hook related to ground level	3.0 m, 10 ft		4.5 m, 15 ft		6.0 m, 20 ft		7.5 m, 25 ft		9.0 m, 30 ft		10.5 m, 35 ft		Max. Reach		
		Along UC	Across UC	Along UC	Across UC	Along UC	Across UC	Along UC	Across UC	Along UC	Across UC	Along UC	Across UC	Along UC	Across UC	max.
Boom : 7.0m (23'0") Arm : 3.9m (12'10") Shoe : 800mm (31") CWT : 10,000kg (22,046lb)	10.5 m kg					*10,460	*10,460							*8,060	*8,060	6.8 m
	35.0 ft lb					*22,230	*22,230							*18,180	*18,180	21.6 ft
	9.0 m kg					*10,190	*10,190	*9,780	*9,780					*7,000	*7,000	8.3 m
	30.0 ft lb					*22,650	*22,650	*20,800	*20,800					*15,580	*15,580	26.9 ft
	7.5 m kg					*9,880	*9,880	*10,350	*10,350	*8,610	8,330			*6,480	*6,480	9.4 m
	25.0 ft lb					*21,890	*21,890	*22,700	*22,700	*16,950	*16,950			*14,340	*14,340	30.5 ft
	6.0 m kg			*9,550	*9,550	*10,770	*10,770	*10,770	*10,770	*9,570	8,270			*6,230	*6,230	10.1 m
	20.0 ft lb			*20,900	*20,900	*23,590	*23,590	*23,440	*23,440	*20,880	17,770			*13,750	*13,750	33.0 ft
	4.5 m kg			*17,860	*17,860	*13,740	*13,740	*11,370	10,720	*9,800	8,070	*6,760	6,230	*6,160	*6,160	10.6 m
	15.0 ft lb			*38,510	*38,510	*29,750	*29,750	*24,690	23,130	*21,320	17,380			*13,580	*13,580	34.6 ft
	3.0 m kg					*15,000	14,190	*11,990	10,260	*10,050	7,820	*8,540	6,130	*6,250	5,850	10.8 m
	10.0 ft lb			*44,290	*44,290	*32,460	30,640	*26,000	22,140	*21,810	16,850	*16,450	13,170	*13,760	12,920	35.4 ft
	1.5 m kg					*15,760	13,430	*12,370	9,830	*10,150	7,570	*8,340	6,010	*6,480	5,750	10.8 m
	5.0 ft lb			*32,670	*32,670	*34,140	28,990	*26,820	21,200	*21,980	16,310	*17,770	12,940	*14,290	12,680	35.5 ft
	0 m kg			*13,330	*13,330	*15,680	12,930	*12,300	9,500	*9,920	7,370	*7,720	5,920	*6,900	5,840	10.6 m
	0 ft lb			*31,240	*31,240	*34,010	27,880	*26,640	20,490	*21,430	15,890			*15,230	12,880	34.8 ft
	-1.5 m kg	*7,980	*7,980	*17,500	*17,500	*14,680	12,680	*11,590	9,300	*9,150	7,260			*6,950	6,160	10.2 m
	-5.0 ft lb	*18,180	*18,180	*40,470	*40,470	*31,830	27,330	*25,060	20,070	*19,650	15,660			*15,310	13,600	33.4 ft
	-3.0 m kg	*13,870	*13,870	*15,750	*15,750	*12,720	12,640	*10,050	9,270	*7,430	7,270			*6,130	*6,130	9.5 m
	-10.0 ft lb	*31,500	*31,500	*34,160	*34,160	*27,460	27,250	*21,570	20,000	*15,510	*15,510			*13,450	*13,450	31.1 ft
-4.5 m kg			*11,480	*11,480	*9,540	*9,540	*7,190	*7,190							8.5 m	
-15.0 ft lb			*24,600	*24,600	*20,320	*20,320	*14,950	*14,950							27.8 ft	
Boom : 7.0m (23'0") Arm : 3.9m (12'10") Shoe : 900mm (35") CWT : 10,000kg (22,046lb)	10.5 m kg					*10,460	*10,460							*8,060	*8,060	6.8 m
	35.0 ft lb					*22,230	*22,230							*18,180	*18,180	21.6 ft
	9.0 m kg					*10,190	*10,190	*9,780	*9,780					*7,000	*7,000	8.3 m
	30.0 ft lb					*22,650	*22,650	*20,800	*20,800					*15,580	*15,580	26.9 ft
	7.5 m kg					*9,880	*9,880	*10,350	*10,350	*8,610	8,400			*6,480	*6,480	9.4 m
	25.0 ft lb					*21,890	*21,890	*22,700	*22,700	*16,950	*16,950			*14,340	*14,340	30.5 ft
	6.0 m kg			*9,550	*9,550	*10,770	*10,770	*10,770	*10,770	*9,570	8,340			*6,230	*6,230	10.1 m
	20.0 ft lb			*20,900	*20,900	*23,590	*23,590	*23,440	*23,440	*20,880	17,910			*13,750	*13,750	33.0 ft
	4.5 m kg			*17,860	*17,860	*13,740	*13,740	*11,370	10,810	*9,800	8,140	*6,760	6,280	*6,160	*6,160	10.6 m
	15.0 ft lb			*38,510	*38,510	*29,750	*29,750	*24,690	23,300	*21,320	17,520			*13,580	*13,580	34.6 ft
	3.0 m kg					*15,000	14,300	*11,990	10,340	*10,050	7,880	*8,540	6,180	*6,250	5,910	10.8 m
	10.0 ft lb			*44,290	*44,290	*32,460	30,880	*26,000	22,310	*21,810	16,990	*16,450	13,290	*13,760	13,040	35.4 ft
	1.5 m kg					*15,760	13,540	*12,370	9,910	*10,150	7,630	*8,340	6,060	*6,480	5,800	10.8 m
	5.0 ft lb			*32,670	*32,670	*34,140	29,230	*26,820	21,380	*21,980	16,450	*17,770	13,060	*14,290	12,800	35.5 ft
	0 m kg			*13,330	*13,330	*15,680	13,030	*12,300	9,580	*9,920	7,430	*7,720	5,980	*6,900	5,890	10.6 m
	0 ft lb			*31,240	*31,240	*34,010	28,110	*26,640	20,660	*21,430	16,030			*15,230	13,000	34.8 ft
	-1.5 m kg	*7,980	*7,980	*17,500	*17,500	*14,680	12,780	*11,590	9,390	*9,150	7,320			*6,950	6,220	10.2 m
	-5.0 ft lb	*18,180	*18,180	*40,470	*40,470	*31,830	27,560	*25,060	20,250	*19,650	15,800			*15,310	13,730	33.4 ft
	-3.0 m kg	*13,870	*13,870	*15,750	*15,750	*12,720	12,720	*10,050	9,350	*7,430	7,340			*6,130	*6,130	9.5 m
	-10.0 ft lb	*31,500	*31,500	*34,160	*34,160	*27,460	*27,460	*21,570	20,170	*15,510	*15,510			*13,450	*13,450	31.1 ft
-4.5 m kg			*11,480	*11,480	*9,540	*9,540	*7,190	*7,190							8.5 m	
-15.0 ft lb			*24,600	*24,600	*20,320	*20,320	*14,950	*14,950							27.8 ft	

Notes: 1. Machine in "Fine Mode-F" (Power Boost) for lifting capacities. 2. The above loads are in compliance with SAE J1,097 and ISO 10,567 Hydraulic Excavator Lifting Capacity Standards. 3. Rated loads do not exceed 87% of hydraulic lifting capacity or 75% of tipping load. 4. Rated loads marked with an asterisk (*) are limited by hydraulic capacity rather than tipping load.

Equipment

STANDARD EQUIPMENT			
	EC300E	EC380E	
Engine			
Turbocharged, 4 stroke diesel engine with water cooling, direct injection and charged air cooler that meets Tier 4f requirements	•	•	
Air filter with indicator	•	•	
Air intake heater	•	•	
Cyclone pre-cleaner	•	•	
Electric engine shut-off	•	•	
Fuel filter and water separator	•	•	
Alternator, 80 A	•	•	
Electric / Electronic control system			
Travel alarm	•	•	
Advanced mode control system	•	•	
Self-diagnostic system	•	•	
Machine status indication	•	•	
Engine speed sensing power control	•	•	
Automatic idling system	•	•	
One-touch power boost	•	•	
Safety stop/start function	•	•	
Adjustable LCD color monitor	•	•	
Master electrical disconnect switch	•	•	
Engine restart prevention circuit	•	•	
LED lights:	•	•	
Frame-mounted 2	•	•	
Boom-mounted 2	•	–	
Boom-mounted 4	–	•	
Cab-mounted 2	•	•	
On counterweight	•	•	
Batteries, 2 x 12 V / 170 Ah	•	–	
Batteries, 2 x 12 V / 200 Ah	–	•	
Start motor, 24 V / 5.5 kW	•	–	
Start motor, 24 V / 7 kW	–	•	
Frame			
Access way with handrail	•	•	
Tool storage area	•	•	
Punched metal anti-slip plates	•	•	
Undercarriage			
Undercover (heavy-duty)	•	•	
Hydraulic track adjusters	•	•	
Greased and sealed track link	•	•	
Track Guard	•	•	

STANDARD EQUIPMENT			
	EC300E	EC380E	
Hydraulic system			
Hose rupture valve: boom	•	•	
Overload warning device	•	•	
Automatic sensing hydraulic system	•	•	
2-pump flow bucket circuit	–	•	
Summation system	•	•	
Boom priority	•	•	
Arm priority	•	•	
Swing priority	•	•	
ECO mode fuel saving technology	•	–	
Boom, arm and bucket regeneration valves	•	•	
Swing anti-rebound valves	•	•	
Boom and arm holding valves	•	•	
Multi-stage filtering system	•	•	
Cylinder cushioning	•	•	
Cylinder contamination seals	•	•	
Auxiliary hydraulic valve	•	•	
Automatic two-speed travel motors	•	•	
Hydraulic oil, ISO VG 46	•	•	
Work tool management system (up to 20 programmable memories)	–	•	
Attachment management system (up to 32 programmable memories)	•	–	
Cab and interior			
High visibility cabin	•	•	
ROPS (ISO12117-2) certified cab	•	•	
Falling object guard (FOG)	•	•	
Silicon oil and rubber mounts with spring	•	•	
Travel pedals and hand levers	•	•	
Adjustable operator seat and joystick control console	•	•	
Control joysticks with 3 switches + 1 proportional	•	•	
Heater & air-conditioner, automatic	•	•	
Flexible antenna	•	•	
AM/FM stereo with MP3, USB and bluetooth input	•	•	
Hydraulic safety lock lever	•	•	
Cab, all-weather sound suppressed, includes:	•	•	
Cup holders	•	•	
Door locks	•	•	
Tinted glass	•	•	
Floor mat	•	•	
Horn	•	•	
Large storage area	•	•	
Seat belt	•	•	
Safety glass	•	•	
Sun screens, front, roof, rear	•	•	
Rain shield	•	•	
Washer and wiper on windshield and roof window	•	•	
Rear view camera	•	•	
Master key	•	•	
Track shoes			
800 mm (32") with triple grousers	•	•	
Digging equipment			
7.0 m (23'0") straight boom	•	•	
Arm: 3.9 m (12'10") Heavy-Duty	–	•	
Arm: 3.05 m (10'0") Heavy-Duty	•	–	
Manual centralized lubrication	•	•	

OPTIONAL EQUIPMENT		
	EC300E	EC380E
Engine		
Block heater: 120 V, 240 V	•	•
Oil bath pre-cleaner	•	•
Diesel coolant heater, 10 kW	•	•
Water separator with heater	•	•
Auto engine shutdown	•	•
Electric		
Travel alarm	•	•
Anti-theft system	•	•
Rotating warning beacon	•	•
Undercarriage		
Full track guard	•	•
Hydraulic system		
Hose rupture valve: arm	•	•
Boom float function with HRV	•	•
Hammer & shear	•	•
1 and 2 pump flow	•	•
Variable flow and pressure pre-setting	•	•
Additional return filter	•	•
Slope & rotator	•	•
Grapple	•	•
Oil leak (drain) line	•	•
Quick coupler piping	•	•
Volvo hydraulic quick coupler S2	•	–
Volvo hydraulic quick coupler S3	–	•
Volvo hydraulic quick coupler U30 / U35	•	–
Volvo hydraulic quick coupler SQ70 55	•	–
Volvo hydraulic quick coupler SQ70	•	–
Hydraulic oil, ISO VG 32	–	•
Hydraulic oil, ISO VG 46	–	•
Hydraulic oil, ISO VG 68	–	•
Hydraulic oil, biodegradable 46	•	•
Hydraulic oil, longlife oil 32	•	•
Hydraulic oil, longlife oil 46	•	•
Hydraulic oil, longlife oil 68	•	•
Counterweight		
10,000 kg (22,046 lb)	–	•
6,900 kg (15,212 lb)	•	–

OPTIONAL EQUIPMENT		
	EC300E	EC380E
Cab and interior		
Fabric seat with heater	•	•
Fabric seat with heater and air suspension	•	•
Deluxe seat	•	•
Pilot control pattern change	•	•
Falling object guard, FOG (fixed type or hinge type)	•	•
Frame-mounted	•	•
Side view camera	•	•
Smoker kit (ashtray and lighter)	•	•
Specific key	•	•
Track shoes		
Track shoes 600/700/900 mm (24"/28"/36") with triple grousers	•	•
Track shoes 600 mm (24") HD with triple grousers and HD links	–	•
Track shoes 600 mm (24") HD with triple grousers	•	–
Track shoes 600 mm (24") with double grousers	•	•
Track shoes 700 mm (28") with double grousers	•	–
Service		
Tool kit, daily maintenance	•	•
Tool kit, full scale	•	•
Automatic lubrication system	–	•
Air compressor	•	•

V O L V O