

V O L V O



Volvo Wheeled Pavers 2.5-9 m 129 kW

P6870D ABG

Volvo Construction Equipment



Welcome to our world

Welcome to a world of industry leading machinery. A world where imagination, hard work and technological innovation will lead the way towards developing a future which is cleaner, smarter, and more connected. A world supported by the enduring values of the Volvo Group. A world of stability, sustainability and innovation. A world which we put our customers at the heart of.

Welcome to the world of Volvo Construction Equipment – we think you're going to like it here.

The road to success

Our range of road machinery combines the heritage of the Ingersoll Rand and ABG brands with the engineering excellence of Volvo. The result is a line-up of Volvo pavers and compactors which achieve an unrivalled level of quality, in both paving and compaction applications.

Building on our proud history, we continue to innovate our products to offer customers the best solutions for their operation. Our Compact Assist and Pave Assist products are just two examples of how we are developing intelligent solutions to ensure our machines deliver world-class performance and results long into the future.



Solutions for you









Our industry leading machines are just the start of your relationship with Volvo. As your partner, we have developed an extensive range of additional solutions to help you improve uptime, boost productivity and reduce costs.

Designed for your business

Structured across nine blocks, our portfolio of products and services are designed to complement your machine's performance and boost your profitability. Simply put, we offer some of the best guarantees, warranties and technological solutions in the industry today.

There when you need us

Whether you're buying new or used, our global network of dealers and technicians offer around-the-clock support, including machine monitoring and world-class parts availability. It's the basis of everything offered by Volvo Services, so you can be confident we've got you covered right from the start.

 <p>Fuel Efficiency Services</p>	 <p>Productivity Services</p>	 <p>Safety Services</p>
 <p>Financial Services</p>	 <p>Uptime Services</p>	 <p>Rental Services</p>
 <p>Volvo Attachments</p>	 <p>Genuine Volvo Parts</p>	 <p>New Life Services</p>

BUILDING TOMORROW

Versatile performer

Experience the ultimate in paving versatility with the P6870D ABG. The highly maneuverable paver combines a compact design with outstanding power and traction, helping you to achieve outstanding results across a wide range of paving applications.

Pave with confidence

A unique hydraulic self-levelling suspension system provides three-point balance for additional machine stability. The suspension further enhances machine traction and smooth paving when working in poor or uneven ground conditions.



Made to maneuver

When working in tight spaces, the unique steering system provides outstanding maneuverability with an inner turning radius of just 2.5m. The smart system provides instant and precise steering, helping to reduce paving time and effort when working in confined jobsites.



Easy mobility

Travel with speed and ease across the work site thanks to a travelling speed of up to 20km/h. When working between sites, the compact dimensions of the P6870D ABG make it easy to transport.



Power to perform

The premium Volvo engine combines high torque and low RPM to deliver superior performance and efficiency. For reduced fuel consumption, the adaptive ECO Mode matches engine output to jobsite requirements.





DRIVING RESULTS

Superior traction and control are assured, whatever the ground or paving conditions, with the Volvo drive system. Available as 6x6 or 6x4, the large rear wheels deliver high drive force, while the load dependent torque control system adjusts power between the front drive wheels to prevent wheel spin.

Paving made easy

Be in complete control of your paver with features designed for simple operation and unrivalled comfort. Combining the next generation Electronic Paver Management system and 360° visibility, the P6870D ABG is the ultimate package to achieve maximum efficiency.

Easy levelling

Introducing a new way of levelling with the integrated system from Volvo, controlled from the large screed panel monitors. Screed operator convenience is further enhanced with quickly assembled control units, thanks to less cables being required, while an extra levelling controller can still be used.



Get straight to work

Simplify machine set up and get straight to work with Settings Manager, which stores customized settings for individual projects, ensuring consistent paving quality from job to job. The integrated feature allows operators to recall saved parameters within EPM3 when working on similar paving jobs. Once paving is underway, fine tuning can be made to optimize performance and productivity.



Pave Assist

Powered by the optional Volvo Co-Pilot, Pave Assist provides a powerful set of digital tools, including Material Manager, Thermal Profiling and Weather View, which are designed to make the operator's life easier, document the paving process and enhance mat quality.



The operator's choice

Operators stay comfortable and alert while at work thanks to low noise levels, footrest and armrest, warm air outlet, USB ports and cup holder. Operator convenience and safety are further enhanced by the hopper lock handle which is now accessed directly from the platform. The home light functionality illuminates the platform for three-minutes when the battery disconnecter is switched on, or when the ignition is switched off.





CONTROL WITH CONFIDENCE

Take control of your operation with the Electronic Paver Management (EPM3) system. Control buttons are consolidated within one system and arranged in a bird's-eye view layout to guide the operator intuitively through individual working functions. Using the jog wheel, operators can quickly select and adjust functions for greater machine control, ease of use and optimum efficiency.

Ultimate screed performance

The P6870D ABG is compatible with a range of high-performance screeds, depending on your requirements and preferences. Featuring the Volvo quick coupling system and special profile solutions, Volvo screeds are built on decades of engineering excellence to deliver the best paving quality.

The screed you need

With a paving width up to 9 meters, the P6870D ABG can be equipped with a range of screeds capable of handling a wide variety of materials. Volvo Variomatic screeds have eight guide tubes, four on each hydraulic extension, which along with the optional screed tensioning device contribute to a consistent and uniformly compacted smooth surface



Fast extension changes

Change screed extensions efficiently and safely and with no special tools required, thanks to the Volvo unique quick coupling system. Assemble a 6.5-meter screed including channel plate, guide plate and auger extension in just 55 minutes.



Easy adjustments

Make manual screed end gate adjustment a thing of the past with the optional hydraulic end gate control, integrated into the screed panel. The result is reduced effort for the screed operator and a guaranteed clean side finish, while also keeping operators safely away from traffic.



Durable by design

You can rely on the specially-designed Volvo tamper bars to perform when it comes to achieving material target density, featuring fully hardened for outstanding durability.





MAKE IT SPECIAL

The VB79 screed offers greater potential when needing to pave special crown profiles in the road surface, such as specific draining requirements. The extendable screed features two additional articulated sections which are adjustable upwards or downwards by 10% (5.7°), creating the possibility to pave irregular profiles with greater ease, less material use and at lower cost.

Keep on paving

With quick and easy maintenance as well as smart systems like CareTrack and the Service Interval Manager, it's easy to keep your hardworking P6870D ABG paver up and running and performing its best.

State-of-the-art servicing

Maximize uptime with quick and safe servicing. Central lubrication points and essential checkpoints are easily located on top of the platform, while the fuel tank, emulsion tank and AdBlue filler neck can be accessed from the ground level. For further convenience, Fleet Managers can unlock service hatches and switch on ignitions across an entire fleet with a single key.



Care Kits

Ensure optimum part performance and lifetime with Care Kits, eliminating the guess work of which parts need replacing by having them all on hand in a single package. Replacing only major or visibly worn parts and not those around them can put stress on the replaced parts. Save time, lower costs, and receive the latest technical improvements with just one kit.



Non-stop productivity

Enjoy round the clock productivity with the 13t hopper and a fuel tank capacity which provides 10 hours continuous paving. Keep your fuel safe and avoid unwanted downtime with the fuel theft prevention system. Keep everything in view when working day or night with our range of lighting kits.



Stay in the know

Stay informed of servicing requirements and maximize machine uptime with the Service Interval Manager. A dedicated menu on the EPM3 control panel proactively alerts the operator to required or scheduled maintenance, which is recorded on the system and retained in the service history record.





EASY MACHINE MONITORING

With the optional CareTrack telematics system you can stay ahead of unscheduled downtime and ensure your machine is being operated efficiently. Remotely receive reports on machine location, usage, productivity, fuel consumption and health to help identify improvement areas and optimize your operation.

Ultimate paving versatility

Superior traction

- Choice of drive concept: 6x6 or 6x4
- Large wheels for high drive force
- Load dependent torque control prevents wheel spin
- Hydraulic self-leveling suspension system with three-point balance

Versatile performer

- 2.5m inner turning radius
- 20km/h travel speed
- 13t capacity hopper
- Volvo engine: high torque at low RPM, adaptive ECO Mode

Paving made easy

- Intuitive Electronic Paver Manager system
- Integrated levelling equipment
- Hopper lock from the platform
- Pave Assist, powered by Volvo Co-Pilot (Option)



State-of-the-art servicing

- Ground level access to fuel tank, emulsion tank and AdBlue filler neck
- Central lubrication point, accessed from the platform
- CareTrack: easy machine monitoring
- Care Kits

Every angle in view

- Flat engine hood
- Glazed areas at the side of the platform
- Near-field mirrors
- Home light functionality
- Volvo Smart View (Option)

The operator's choice

- Quiet operation
- All-weather roof with sliding extensions
- Footrests, armrests, extendable seats
- Warm air outlet, cup holder, USB ports

Industry-leading screed technology

- Range of screeds to pave up to 9 meters
- VB79 for all profiles, including special crown
- Quick coupling system
- Fully-hardened tamper bars

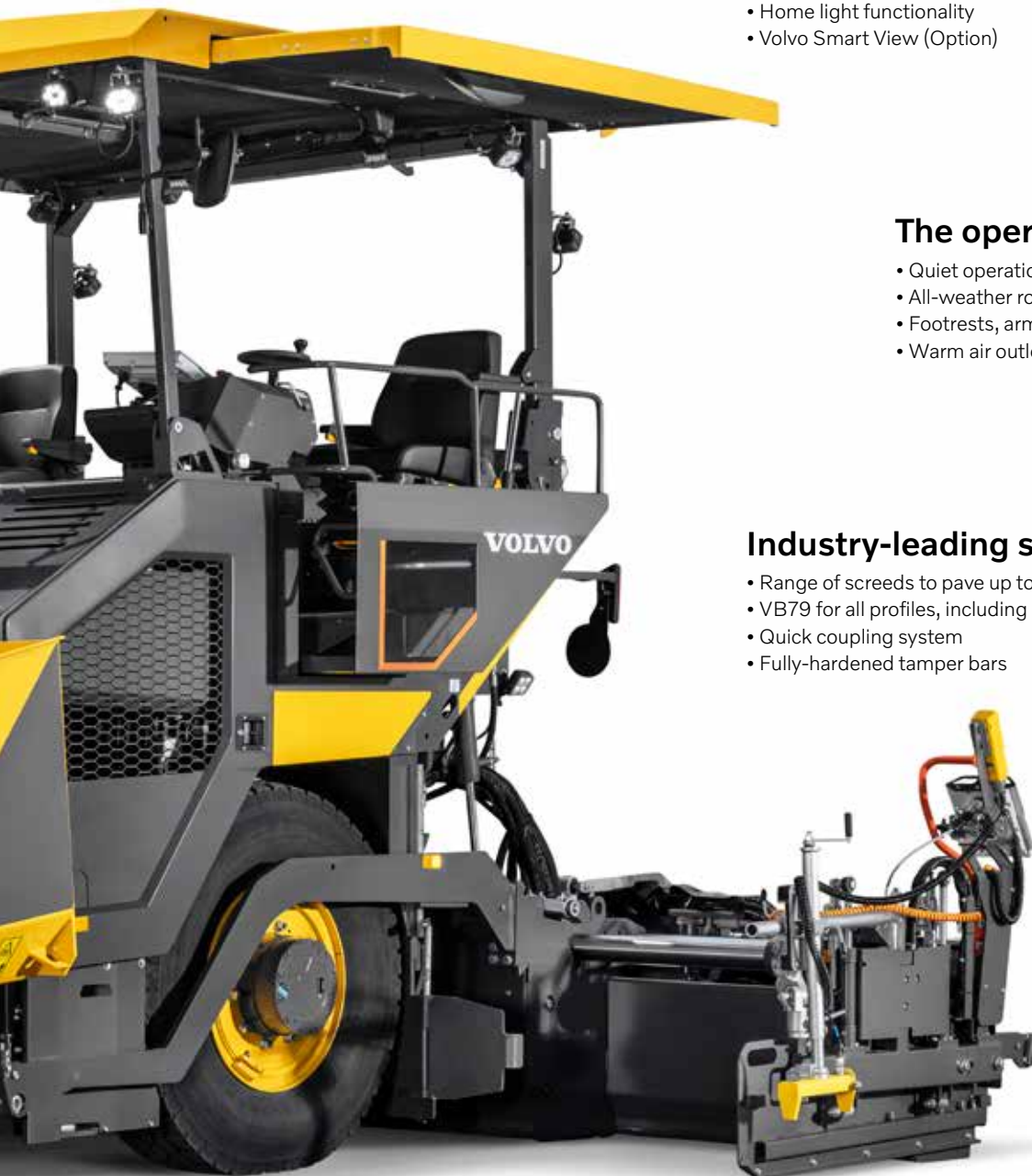

Volvo P6870D ABG in detail

Engine	
Manufacturer	Volvo
Model	D6J
Fuel	Diesel
Output	kW 129
	hp 175.4
at engine speed	r/min 2 000
Coolant	Liquid
Fuel tank capacity	l 200
Exhaust emission	EU Stage V

Electrical system	
Battery voltage	V 24

Paving	
Output (theoretical)*	t/h 700
Mat thickness (max.)	mm 300

Speed	
Paving (max.)	m/min 40
Transport (max.)	km/h 20

Propulsion	
Drive units rear	number 2
Drive units front	number 4

Wheel/Tires	
-------------	--

Rear wheels	
Type	Pneumatic tires
Number	number 2
Dimension	385/95R25

Front steering wheels	
Type	Elastic tires
Number	4
Diameter	mm 580
Width	mm 340

Conveyor	
Hopper capacity	t 13
Number of conveyors	2
Conveyor speed (max.)	m/min 21.5

Auger	
Number of augers	2
Speed (max.)	1/min 90
Diameter	mm 360

Dimensions	
Length with Vario Screed (Walkway up)	mm 6 152
Length	mm 6 402
Width	mm 2 548
Height	mm 3 837
Height (transport)	mm 2 970

Weight**	
Tractor unit	kg 14 300

Max. allowable gradeability***	
Tractor unit + screed	% 25

Sound Level	
Driver's ear, according to ISO 11201	
L _{PA}	dB 84
Guaranteed sound power level according to ISO 6395 / Directive 2000/14/EC	
L _{WA}	dB 104

Vibration	
Hand-Arm vibration according to ISO 5349:2001	m/s ² <2.50
Whole Body vibration according to ISO 2631:1997	m/s ² <0.50

Notes	
*The actual paving output depends upon mat thickness, paving width and paving speed, and will vary according to conditions prevailing on your jobsite. We can assist you in calculating the paving output for a specific project.	
**Approximative weight, without options. Tires filled with water, fuel tank half-full, 75 kg operator and weather roof included.	
***Applies to screed VB 78 2.5-5.0 m. When using extensions the maximum allowable gradeability will be reduced.	

OPERATING WEIGHTS ¹ OF SCREEDS							
Working width	5.0 m	6.0 m	6.5 m	7.5 m	8.0 m	8.5 m	9.0 m
VB781	kg 3 600	-	5 222	5 802	6 342	-	6 923
VB791	kg 4 050	-	5 672	6 252	-	-	-
VB881	kg -	4 050	-	5 772	-	6 352	6 892
VB891	kg -	4 500	-	6 222	-	-	-

* Including auger extensions, channel plates, end gates, etc...

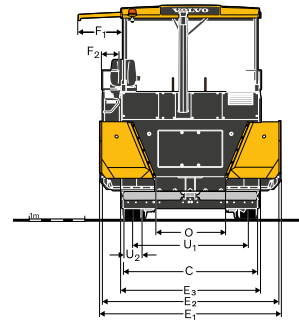
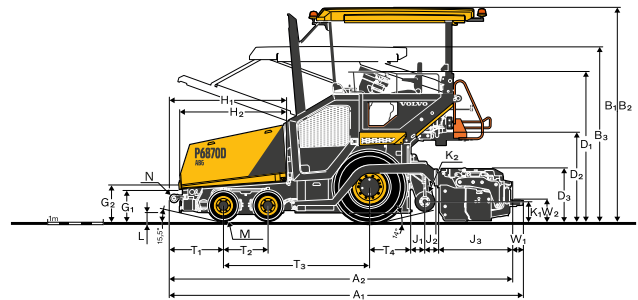

DIMENSIONS			
A ₁	Operating length	mm	6 402
A ₂	Shipping length	mm	6 152
B ₁	Operating height	mm	3 837
B ₂	Height weather roof	mm	3 837
B ₃	Shipping height	mm	2 970
C	Tractor width	mm	2 548
D ₁	Height railing	mm	2 700
D ₂	Deck height	mm	1 605
D ₃	Screed height	mm	938
E ₁	Outer hopper width	mm	3 256
E ₂	Inner hopper width	mm	3 176
E ₃	Width oscillating beam	mm	2 495
F ₁	Extension weather roof	mm	770
F ₂	Seat console extension	mm	317
G ₁	Inner loading height	mm	592
G ₂	Outer loading height	mm	688
H ₁	Hopper length to push roller	mm	2 118
H ₂	Hopper length	mm	1 939
J ₁	Distance rear wall auger centre	mm	275
J ₂	Distance auger centre screed	mm	265
J ₃	Screed depth	mm	1 297
K ₁	Auger height to ground (center)	mm	350-60
K ₂	Diameter auger	mm	360
L	Ground clearance	mm	145
M	Diameter wheel	mm	540
N	Diameter push roller	mm	160
O	Conveyor width	mm	1 270
S ₁	Basic screed width VB78+VB79	m	2.5
	Basic screed width VB88	m	3.0
S ₂	Extended screed width VB78+VB79	m	5.0
	Extended screed width VB88	m	6.0
T ₁	Front wheel/track to push roller	mm	970
T ₂	Distance front wheels	mm	800
T ₃	Track length/wheel base	mm	2 625
T ₄	Track/wheel distance to rear wall	mm	720
U ₁	Wheel/track gauge	mm	2 076
U ₂	Track pad width/wheel width	mm	340
W ₁	Width of walkway	mm	305
W ₂	Height of walkway	mm	434

Equipment

STANDARD EQUIPMENT

Engine
Volvo Diesel engine, EU Stage V
Drive
Electronic drive control
Independent rear wheel drives
Driven front axle 2x4
Hydraulic ride levelers
Load dependent efficient drive system
Active steering
Rear wheels with ballast
Material Management
Heavy push rollers
Proportional conveyor control
Proportional ultrasonic auger control
Four individual hydrostatic drives for conveyors and augers
Reversible direction of auger rotation
Hydraulic auger height adjustment
Electrics and electronics
Electronic Paver Management (EPM 3)
Back-lit controls
ECO mode adaptive
Settings Manager
Service Interval Manager
Steering angle indication
Head of material indication
Adjustable and slidable control station
Two adjustable and revolving screed control panels
Battery master switch
Electric switch cabinet
Back-up alarm
Fuel theft detection
Tool kit
MATRIS support
Structure
Manual folding all-weather roof Glass-fibre Reinforced Plastic (GRP)
Two seats, laterally extendable
Integrated vandalism protection
Near field mirrors at weather roof
Volvo Green Key
Storage compartments under both seats
Cup holder
USB charging sockets
Screed
Split towing arms
Screed lock
Hydraulic crown adjustment VB screeds
24V sockets at screed distribution box
Lights
Operator's platform lighting
Home light function
Lamp levelling scale LED
Environmental
Sound insulation for engine compartment and operator station

OPTIONAL EQUIPMENT

Drive
Driven front axle 4x4
Material Management
Heavy duty auger
Soft Dock
Smart Dock
Individually operating hopper wings
Hydraulically operated front apron
Protective half shells for auger shaft
Auger extensions and additional auger bearings
Heavy duty conveyor cover
Reversible conveyor
Central lubrication
Electrics and electronics
Integrated levelling
Four 230V power sockets
Lateral emergency stop
Traction isolator switch
CareTrack - GSM installation
CareTrack - Satellite installation
Pave Assist (Volvo Co-Pilot system)
Volvo Smart View camera system
Levelling equipment
Transport case for EPM 3 control panels
Structure
StVZO-Kit 11,5t for Germany
StVZO-Kit 12t for Austria
Homologation 12t for Switzerland
Homologation for Italy
Electrohydraulic powered weather roof
Deluxe seats with heating
Front windscreen incl. wiper and washer system
Tarpaulin side curtains for weather roof
Custom colours
Front ballast weight
Screed
Screed assist
Screed tensioning device
Screed spacer blocks
Hydraulic height adjustment of extendable screed
Special profiles VB79, VB89
Hydraulically adjustable Power-Float screed end gates
Heatable screed end gate
Lights
Basic Kit Halogen
Basic Kit LED
Work Plus Kit LED
Full Night Kit LED
Warning beacons LED
Two balloon lights LED
Road travel lighting left-hand traffic
Road travel lighting right-hand traffic
Environmental
Extractor for bituminous fumes
Emulsion spraying system incl. hose reel
High performance spray cleaning unit
Biodegradable hydraulic oil

SELECTION OF VOLVO OPTIONAL EQUIPMENT

Fume extractors



Hydraulic end-gates



Smart Dock



Levelling equipment – compatible with major 3D systems



Lighting kits



Powered weather roof



Not all products are available in all markets. Under our policy of continuous improvement, we reserve the right to change specifications and design without prior notice. The illustrations do not necessarily show the standard version of the machine.

V O L V O