

V O L V O



Volvo Articulated Haulers  
Imperial: 45.2 ton(us) / 90,389lb / 479HP  
Metric: 41t / 41,000kg / 357kW

**A45G FS**

Volvo Construction Equipment





## Being the first. Keeping the lead.

Since introducing Gravel Charlie, the world's first series manufactured articulated hauler, Volvo has consistently led the way when it comes to pioneering technology which delivers unrivalled levels of sustainable productivity and performance.

Today we offer the most comprehensive range of articulated haulers in the industry, with common technology throughout, ensuring optimum results whatever size class you operate. Combined with a range of complementary services and solutions, you can count on Volvo Articulated Haulers to deliver the lowest possible cost per tonne.

As part of our enduring focus on environmental care we are committed to Science Based Targets to achieve net-zero value chain emissions by 2040. From product planning through to end-of-life, our focus continues to be on minimizing our global footprint and driving transformation in our industry.

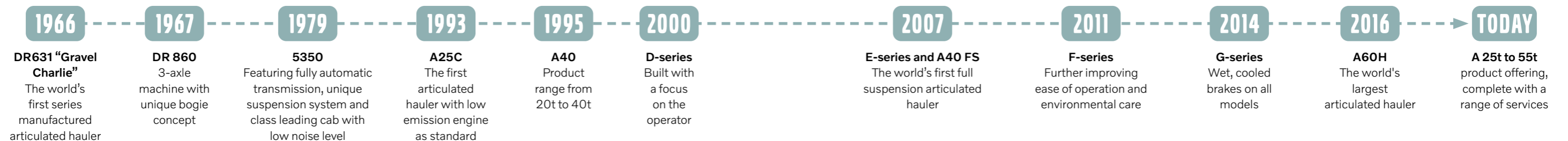
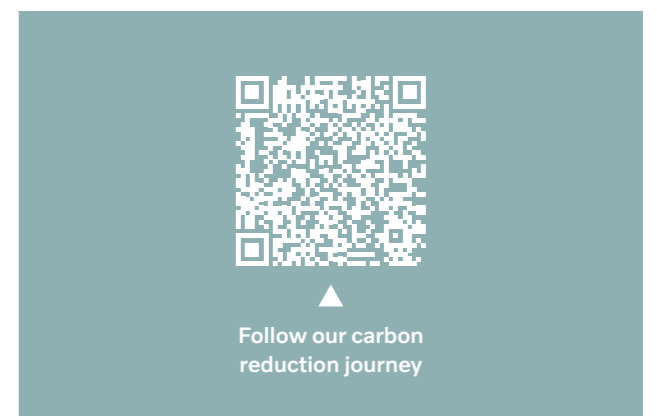



# Keep on moving

Effective maintenance can have a big influence on your total cost of ownership. Volvo Articulated Haulers are designed to be easy to service, helping you to maximize your uptime and keep maintenance costs to a minimum.

## Reduce oil volume by half

When measured over the lifetime of the machine, Volvo Articulated Haulers require less than half the fluid volume compared to competition, benefitting both the environment and your operating costs.



## 1,000hr engine service intervals

Volvo Engine Oil and High Performance Filters offer 1000 hour engine service intervals. The result is 50% less oil and filters – reducing maintenance requirements as well as your environmental impact.



## Easy to service

Servicing your machine is quick and easy thanks to industry leading service access and essential maintenance points accessible from the ground. The front grill swings down, opening a service platform with anti-slip steps and the electric hood opens to 90 degrees, allowing full access to the engine compartment.



## Service alerts

Fluid levels are constantly monitored with timely service alerts displayed on the dashboard, helping you stay on top of your maintenance requirements.



  
Reduce your maintenance costs with Volvo Articulated Haulers.



# NO DAILY OR WEEKLY GREASING

With Volvo Articulated Haulers greasing is only required every 250 hours – the best in the industry – delivering maximum uptime.



# Haul Assist

Gain access to a set of tools designed to help you get the most out of your Volvo Articulated Hauler and boost your profitability.

## Proactive tire management

Optimize tire life with the support of the Tire Pressure Monitoring System, which allows the operator to monitor tire pressure and temperature from the comfort of the cab.



## A complete site overview

Monitor the whereabouts of all your machines, vehicles and visitors in real-time with Map, a connected tool which provides accurate positioning to help monitor on-site traffic and navigate the site more efficiently.



## Go into detail

Reports can be generated automatically on a daily and weekly basis, or manually at any time, including the geo-tracking of moved material which is enabled by Map.



## Support you can count on

As a fully integrated and factory-fitted Volvo system, all the components, hardware and software of Haul Assist are supported by your Volvo dealer to keep your operation running smoothly. What's more, you will benefit from over-the-air updates, easy upgrades and remote support.



# TAKE CONTROL OF YOUR PRODUCTIVITY

On-Board Weighing provides real-time payload information which can help to eliminate carry-back and overloading; the result is peak productivity, reduced fuel consumption and less machine wear.



# Move more for less

Boost your profits with Volvo Articulated Haulers, designed to deliver high productivity at the lowest cost per tonne.

## Optimized payload

The machine is optimized for efficiency featuring high payload capabilities. Its smart design allows for more capacity while reducing fuel consumption so you can move more for less.



## Volvo dynamic drive

Dynamic and predictive gear selection adapts to operating conditions, for improved comfort and fuel efficiency.



## Simply the best

The machine delivers unbeatable off-road performance in its class with features including proven Volvo drivetrain, automatic drive combinations including 100% differential locks, all-terrain bogie and hydro-mechanical steering.



## Smooth descent

Make your daily job easier with downhill speed control. The function automatically maintains a constant speed when operating on downward gradients and is the perfect alternative to the retarder pedal for a more efficient and comfortable shift.



 Volvo Articulated Haulers deliver the highest profitability.



# INTELLIGENT EFFICIENCY

Experience superb fuel efficiency without compromising on power and performance thanks to the world-renowned Volvo drivetrain, including Terrain Memory. The intelligent function identifies and remembers slippery road segments to ensure optimized traction control – the result is excellent off-road mobility.



# Comfort at speed

Rough roads? Just relax and step on the gas. The A45G FS features unique technology which delivers superior productivity, travel speed and cycle times when compared to other haulers.

## Unique suspension

The unique front suspension is equipped with a set of accumulators and adapts to both payload and ground conditions, delivering unbeatable operator comfort. The rear suspension features two high pressure accumulators for loaded operations and two low pressure accumulators for unloaded operations. The cross flow between the hydraulic cylinders stabilizes both trailer and tractor, allowing for higher average speeds over poor ground structures.



## Active leveling sensors

Six level sensors actively monitor the frame movement in relation to the axles and signal the hydraulic system to adjust the suspension, optimizing stability during travel.



# Put to the test

This example shows how replacing conventional suspension haulers (A45G) with full suspension haulers (A45G FS) can have a large effect on your business. It's based on a fleet of 16 articulated haulers, with a total haul cycle of 3.1 kilometers (1.9 miles).



## Total fleet size -18%

By using Full Suspension haulers, you can reduce your fleet size to move the same amount of material.

## Average cycle time -20%

Due to the ability of the Full Suspension machine to drive faster over challenging terrain, cycle times are significantly reduced.

## Productivity +25%

Faster cycle times result in an increase of hauler production per operating hour.

## Cost of ownership -13%

With fewer machines, delivering faster cycle times, the fleet total cost of ownership is reduced.

## Cost per tonne -13%

A side-by-side study of an A45G compared to an A45G FS showed the A45G FS delivered a lower cost per tonne.



▲  
Watch The Race between the full suspension and standard suspension Volvo haulers!



# Control in comfort

Featuring superior comfort, ease of operation and safety, the industry-leading cab appeals to operators and helps maintain productivity all day, every day.

## Total control

Volvo Articulated Haulers are packed with features to help operators get the most from the machine. Intelligent functions such as cruise control, downhill speed control and hill assist help control the hauler with ease and efficiency, for enhanced safety and productivity in all conditions.



## Ease of operation

The ergonomic, comfortable and easy-to-understand controls are designed to suit all operators. Additional automatic functions such as OptiShift – which enables fast and smooth directional changes – further enhance ease of operation.



## Operator comfort

Feel comfortable and spend more time in the Volvo Articulated Haulers. The centrally positioned operator, superior steering, excellent suspension, low noise levels, climate control, space and visibility reduce operator fatigue for more effective operations.



## Safety first

Whether its operators, trainers, technicians or site workers – safety on site is of fundamental importance. In the Volvo Articulated Haulers superior visibility and efficient lighting combine with features such as the brake test and dump support, helping to keep everyone working around the machine safe.



Volvo Articulated Haulers are the operator's number one choice.

# OPERATOR'S CHOICE

A happy operator is a more productive operator and when many other machines are onsite, most operators prefer the Volvo. Even in the most adverse conditions, its comfortable cab and ease of operation keep operators alert and performing their best.



# The ultimate Hauler

## Only from Volvo

- Industry-leading Volvo engine and driveline: high performance, high fuel efficiency
- Terrain Memory function: optimized engagement of the traction control for excellent off-road mobility
- Volvo dynamic drive
- Automatic drive combinations including 100% differential locks, all-terrain bogie and hydromechanical steering
- OptiShift: fast and smooth directional changes

## The operator's choice

- Ease of operation: ergonomic and easy-to-understand controls
- Centrally positioned operator for best-in-class visibility
- Cruise control, hill assist, dump support system, load and dump brake
- The downhill speed control function automatically maintains a constant speed when operating on downward gradients
- Built-in brake test: schedule and perform a stationary brake test, guided by the machine display

## Solutions for you

- Easy machine monitoring: CareTrack, ActiveCare Direct
- Lifetime Frame and Structure Warranty
- 24hr parts delivery guarantee
- Genuine Volvo Parts
- Volvo Site Simulation: get recommendations on the best fleet configuration and site set-up
- Operator Training Program: unlock the full potential of your machine
- Uptime Services: control your maintenance costs

## Proven full suspension concept

- Reduce total fleet size by 18%
- Reduce average cycle time by 20%
- Increase productivity by 25%
- Reduce cost per tonne and cost of ownership by 13%
- Unique suspension contributing to a smooth and productive ride
- Active leveling sensors deliver optimized stability

## Haul Assist

- On-Board Weighing: real-time payload monitoring
- Tire Pressure Monitoring System
- Map: real-time positioning of on-site traffic
- Productivity Reports, including the geo-tracking of moved material
- Over-the-air updates, easy upgrades, remote support

## Service and maintenance

- 250-hour greasing interval
- Half the fluid volume compared to the competition
- 1,000hr engine service intervals
- Service reminders and fluid level monitoring
- Industry-leading service access and ground-accessible service points





# Configured for success

Ensuring your fleet is configured in the correct way can yield huge benefits to your operation including more productivity, enhanced performance and less costs.

Here are some tips to help tailor your new Volvo Articulated Hauler according to the application, site conditions and type of transported material, as well as matching to the appropriate loading unit. For more detailed information, talk to your Volvo dealer!

## Body options

Question	Answer	Solution
<b>Dealing with height restrictions?</b> Operating in restricted height conditions e.g. silos or underground	No Yes	Select standard body Select low profile body
<b>Hauling abrasive material?</b> Granite, silicate etc	No Yes	<i>Go to next question</i> Select wear plates / rock liners for extended service life
<b>What material density?</b> Gravel is ~1.4 sh tn/yd <sup>3</sup>	> 1.3 sh tn/yd <sup>3</sup> (gravel, blasted rock) 1.0 - 1.3 sh tn/yd <sup>3</sup> (dry earth, shale) < 0.85 sh tn/yd <sup>3</sup> (coal, fly ash etc)	<i>Go to next question</i> Select side extensions to increase body volume Select light material kit to increase body volume
<b>Front spill protection needed?</b> Getting loaded by large excavator	No Yes	<i>Go to next question</i> Select front spillguard
<b>Extra load retention needed?</b> Risk of dropping material e.g. when climbing steep inclines	No Yes, but not hauling boulders Yes, hauling boulders	<i>Go to next question</i> Select tailgate – overhung type – to reduce spillage Select tailgate – underhung type – to reduce spillage
<b>Hauling sticky material?</b> Risk of carry-back	No Yes	<i>Go to next question</i> Select body exhaust heating

Exceeding gross machine weight is not permitted. Payload should be reduced by the weight of the optional equipment.

## Tires

Question	Answer	Solution
<b>Operating on abrasive haulroad?</b> Risk of tire cuts or extensive wear	No Yes	E3 tires are optimized for soft ground, offering the best traction and high average speed Select E4 tires for the best cut resistance, comfort and tread life
<b>Extra flotation needed?</b> Risk of sinkage in soft ground	No Yes	Select standard profile tires Select low profile tires, featuring lower ground pressure for improved flotation, stability and comfort



## Optimal pass-matching

Volvo Excavator	EC380	EC480	EC530	EC550	EC750	EC950
	Number of passes					
A45G FS	11	8	7	6	5	4

Excavator overcapacity, 3 buckets or below
Well matched, 4-6 buckets (≈ 90 seconds loading time)
Excavator undercapacity, 7 buckets or more
Excavator undersized for optimum match

Volvo Wheel Loader	L150	L180	L220	L260	L350
	Number of passes				
A45G FS	6	5	5	4	3

Loader overcapacity, 2 buckets or below
Well matched, 2-3 buckets (≈ 90 seconds loading time)
Loader undercapacity, 4 buckets or more
Loader undersized for optimum match. Reach might also be an issue



## Hauler chassis solutions

With Special Application Solutions and different chassis options you can tailor Volvo Articulated Haulers to your specific needs.





# Volvo A45G FS in detail

Engine		
V-ACT, 16 liter, 6-cylinder straight VGT (Variable Geometry Turbocharged) diesel engine with 4 valves per cylinder, overhead camshaft and electronically controlled unit injectors. It has wet replaceable cylinder liners and replaceable valve guides and valve seats.		
The engine has cooled EGR (Exhaust Gas Recirculation) and exhaust after treatment with EAT-Muffler (Exhaust After treatment) including DOC (Diesel Oxidation Catalyst), DPF (Diesel Particulate Filter) and SCR (Selective Catalytic Reduction) with an electronically controlled UDS (Urea Dosing System).		
After treatment system features passive DPF regeneration with an AHI (After treatment Hydro carbon Injection) device as back up.		
Engine model	Volvo	D16J
Max power - SAE J1995 Gross	kW (hp)	357 (479)
at engine speed	r/min (r/s)	1,800 (30)
Flywheel power - ISO 9249, SAE J1349 Net	kW (hp)	354 (475)
at engine speed	r/min (r/s)	1,800 (30)
Max torque - SAE J1995 Gross	Nm (ft lbf)	2,576 (1,900)
Max torque - ISO 9249, SAE J1349 Net	Nm (ft lbf)	2,551 (1,882)
at engine speed	r/min (r/s)	1,050 (17.5)
Displacement	l (in <sup>3</sup> )	16.1 (982)
Electrical System		
All cables, sockets and pins are identified. Cables are enclosed in plastic conduits and secured to main frame. Halogen lights. Prewired for options. Connectors meet IP67 standard for water-proofing as necessary.		
Voltage	V	24
Battery	V	2x12
Battery capacity	Ah	2x225
Alternator	kW/A	3.396/120
Starter motor	kW	9
Drivetrain		
Torque converter with built-in lock-up function.		
<b>Transmission:</b> Fully automatic Volvo PowerTronic planetary transmission with nine forward gears and three reverse gears. The transmission has the ability to skip gears for fast and accurate gear selection.		
<b>Dropbox:</b> Volvo-developed, in-line design with high ground clearance and 100% longitudinal "dog clutch" type differential lock.		
<b>Axles:</b> Heavy duty, purpose built Volvo design with fully floating axle shafts, planetary type hub reductions and 100% dog clutch type diff-lock. Automatic traction control system (ATC).		
Torque converter		2.1:1
Transmission	Volvo	PT 2529
Dropbox	Volvo	IL2 ATC
Axles	Volvo	ARB H40
Brake system		
Fully hydraulic, wet multiple disc brakes with enclosed, forced oil-cooled multiple discs on all wheels. Two circuit brake system. Complies with ISO 3450 at total machine weight.		
<b>Circuit division:</b> One circuit for front axle and one for bogie axles.		
<b>Parking brake:</b> Spring-applied disc brake acting on the trailer unit propeller shaft. When the parking brake is applied, the longitudinal differential locked.		
<b>Retarder:</b> Service brake retarder function and Volvo Engine Brake (VEB).		
Steering System		
Hydro-mechanical articulated steering, self compensating design. Two double-acting steering cylinders.		
<b>Steering angle:</b> 3,4 steering wheel turns lock-to-lock, ±45°.		
Steering system, including secondary steering fulfills ISO 5010.		
Chassis		
<b>Frames:</b> box type, heavy duty. High strength steel, robot welded.		
<b>Rotating hitch:</b> 100% maintenance free, fully sealed, with permanently greased tapered roller bearings.		

Cab		
Mounted on rubber pads. Ergonomically designed. Easy entry and exit. Wide angle forward view.		
Operator centrally positioned above the front axle. Adjustable operators seat with retractable seat belt.		
Tilt/telescopic steering wheel. Ergonomically positioned controls. Filtered air. Climate control system.		
<b>Operator communication system:</b> Contronics.		
Large color display, user-friendly and easy-to-understand information, all vital machine functions are constantly monitored.		
Instructor seat with seat belt.		
<b>Safety:</b> ROPS/FOPS standards approved according to ISO3471, SAE J1040 / ISO3449, SAE J231.		
Sound level in cab (ISO 6396) - L <sub>pA</sub>	dB	72
External sound level (ISO 6395) - L <sub>WA</sub>	dB	112
Internal sound level with sound kit: 70 dB(A)		
External sound level with sound kit: 110 dB(A)		
Hydraulic system		
<b>Pumps:</b> Four variable displacement piston pumps driven by the flywheel PTO.		
Two load-sensing used for steering and tipping and two electrical controlled used for fan, brake cooling and brake power supply.		
One ground-dependent piston pump for secondary steering mounted on the dropbox.		
Two return oil filters with magnetic cores provide effective oil filtration.		
System max working pressure	MPa (psi)	26 (3,771)
Dumping System		
Patented Load and Dump Brake.		
<b>Dumping Cylinders:</b> two single stage double acting cylinders.		
Tipping angle	°	70
Tipping time with load	s	12
Lowering time	s	10
Body		
Plate thickness		
Front	mm (in)	8 (0.31)
Sides	mm (in)	11 (0.43)
Bottom	mm (in)	14 (0.55)
Chute	mm (in)	16 (0.63)
Material		
HB450 steel		
Yield strength	N/mm <sup>2</sup> (psi)	1,150 (166,793)
Tensile strength	N/mm <sup>2</sup> (psi)	1,350 (195,801)
Load Capacity		
Standard Body		
Load capacity	kg (sh tn)	41,000 (45.2)
Body, struck	m <sup>3</sup> (yd <sup>3</sup> )	19.7 (25.8)
Body, heaped 2:1	m <sup>3</sup> (yd <sup>3</sup> )	25.1 (32.85)
With overhung tailgate		
Body, struck	m <sup>3</sup> (yd <sup>3</sup> )	20.2 (26.4)
Body, heaped 2:1	m <sup>3</sup> (yd <sup>3</sup> )	26.2 (34.3)
Suspension		
Unique, full hydraulic, on all wheels with automatic leveling and stabilizer. Part of the machine's hydraulic system, uses the same hydraulic oil.		
Hydraulic cylinders (struts), front/rear		2/4
Accumulators, oil-nitrogen, high pressure, front		2
Accumulators, oil-nitrogen, high/low pressure, rear		2/2
Levelling sensors		2+2+2

# Specifications

REFILL CAPACITIES				
Crankcase	l	gal	55	14.5
Fuel tank	l	gal	480	126.8
Cooling system	l	gal	49	12.9
Brake cooling system	l	gal	188	49.7
Transmission	l	gal	43	11.4
Dropbox	l	gal	9	2.4
Axles, front/bogie	l	gal	26/52	6.9/13.7
Hydraulic tank	l	gal	210	55.5
DEF	l	gal	39	10.3

OPERATING WEIGHT UNLOADED				
Tires 29.5R25*				
Front	kg	lb	17,000	37,479
Rear	kg	lb	14,900	32,849
Total	kg	lb	31,900	70,327
Payload	kg	lb	41,000	90,389

Operating weight includes all fluids and operator  
 \*) A45G FS with tires 875/65R25, add 300 kg (660 lb)/axle

TOTAL WEIGHT				
Tires 29.5R25*				
Front	kg	lb	21,150	46,628
Rear	kg	lb	51,750	114,089
Total	kg	lb	72,900	160,717

\*) A45G FS with tires 875/65R25, add 300 kg (660 lb)/axle

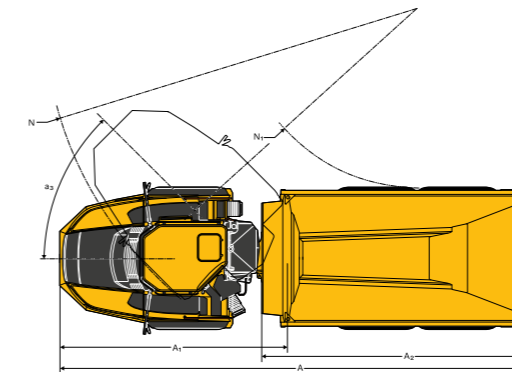

SPEED				
Forward				
1	km/h	mph	5.8	3.6
2	km/h	mph	8.5	5.3
3	km/h	mph	10.4	6.5
4	km/h	mph	15	9.3
5	km/h	mph	21.6	13.4
6	km/h	mph	27.3	17.0
7	km/h	mph	36.1	22.4
8	km/h	mph	47.8	29.7
9	km/h	mph	57	35.4
Reverse				
1	km/h	mph	6.5	4.0
2	km/h	mph	9.4	5.8
3	km/h	mph	18	11.2

GROUND PRESSURE					
Tires	29.5R25		875/65R25		
Unloaded					
Front	kPa	psi	114	16.5	100
Rear	kPa	psi	48	7.0	43
Loaded					
Front	kPa	psi	143	20.7	125
Rear	kPa	psi	174	25.2	152

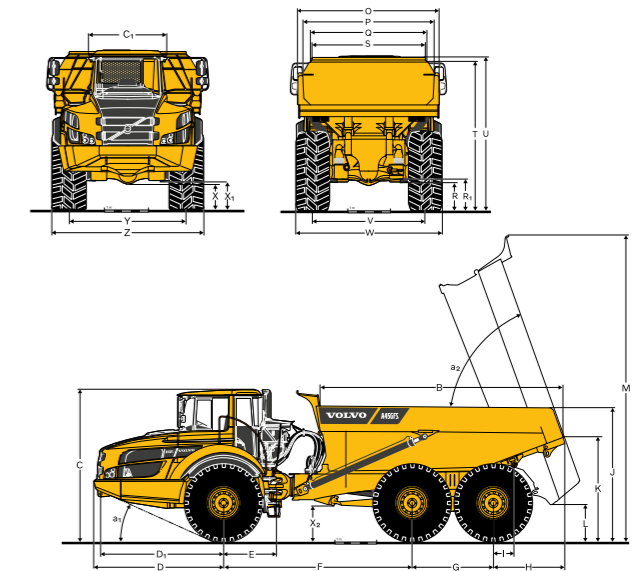

DIMENSIONS				
Pos	Unit	A45G FS		
A	mm ft in	11 263		36'11"
A <sub>1</sub>	mm ft in	5 476		18'
A <sub>2</sub>	mm ft in	6 404		21'0"
B	mm ft in	5 844		19'2"
C	mm ft in	3 599		11'10"
C <sub>1</sub>	mm ft in	1 772		5'10"
D	mm ft in	3 100		10'2"
D <sub>1</sub>	mm ft in	2 942		9'8"
E	mm ft in	1 277		4'2"
F	mm ft in	4 518		14'10"
G	mm ft in	1 940		6'4"
H	mm ft in	1 706		5'7"
I	mm ft in	495		1'7"
J	mm ft in	3 200		10'6"
K	mm ft in	2 435		8'
L	mm ft in	822		2'8"
M	mm ft in	7 265		23'10"
N	mm ft in	8 957		29'5"
N <sub>1</sub>	mm ft in	4 327		14'2"
O	mm ft in	3 430		11'3"

DIMENSIONS				
Pos	Unit	A45G FS		
P	mm ft in	3 118		10'3"
Q	mm ft in	2 820		9'3"
R	mm ft in	613		2'0"
R <sub>1</sub>	mm ft in	640		2'1"
S	mm ft in	2 651		8'8"
T	mm ft in	3 427		11'3"
U	mm ft in	3 546		11'8"
V	mm ft in	2 636		8'8"
W	mm ft in	3 403		11'2"
X	mm ft in	553		1'10"
X <sub>1</sub>	mm ft in	640		2'1"
X <sub>2</sub>	mm ft in	788		2'7"
Y	mm ft in	2 636		8'8"
Z	mm ft in	3 403		12'
a <sub>1</sub>	°		25	
a <sub>2</sub>	°		70	
a <sub>3</sub>	°		45	

A45G FS: Unloaded machine with 29.5R25 tires.



# Equipment

## STANDARD EQUIPMENT

<b>Engine</b>
Direct injected, electronically controlled, turbocharged, intercooled
Grouped oil filters
Preheater for easier cold starts
VEB (exhaust retarder EPG + compression brake)
<b>Tires</b>
29.5R25
<b>Drivetrain</b>
6x4 and 6x6 automatically engaged drive modes
Dog clutch type 100% diff-locks in all axles
Full automatic transmission
Dropbox with longitudinal diff-lock
Torque converter with automatic lock-up
<b>Electrical System</b>
120 A alternator
Battery disconnect switch
Extra 24 V socket for lunch cooler
Lights:
Back-up light
Brake lights
Cab lighting
Direction indicators
Headlights
Instrument lighting
Parking lights
Rear lights
<b>Brake system</b>
Hill assist
Load & Dump Brake
Retarder pedal
Parking brake on propeller shaft
Two circuit, fully hydraulic, wet discs on all axles
<b>Body</b>
Body prepared for exhaust heating and optional equipment
<b>Safety</b>
Anti-slip steps and platforms
Dump body lock
Handrails on steps and platforms
Hazard lights
Horn
Protective grill for cab rear window
Rear-view mirrors
Retractable 3-inch safety belt
ROPS/ FOPS - certified cab
Secondary steering
Steering joint lock
Windshield washers
Windshield wipers with interval function
Dump support system

## STANDARD EQUIPMENT

<b>Comfort</b>
ACC control panel
Ashtray
Cab heater with filtered fresh air and defroster
Can holder /storage tray
Instructor seat with seat belt
Overhead console for radio
Sliding window
Space for lunch cooler
Storage box
Sun visor
Tilt/telescopic steering wheel
Tinted glass
<b>Operator information interface</b>
Gauges:
Brake pressure
Fuel
Speedometer
Tachometer
Wet disc brakes cooling oil temperature
<b>Warning lights grouped and easy to read</b>
Central warning (3 levels) for all vital functions
<b>Central positioned information display</b>
Automatic pre-start checks
Clock
Hour meter
Operational information, easy-to-navigate menu
Troubleshooting diagnostics
<b>Exterior</b>
Front mudguard wideners and rear mudflaps
<b>Service and maintenance</b>
Electrical engine hood
Drainage hose
Machine Tracking Information System MATRIS
Service platform integrated in the front grill
Tool box

## OPTIONAL EQUIPMENT

<b>Engine</b>
Air filter, heavy duty, EON
Engine heater, 240 V
Engine heater, diesel (Eberspächer)
Engine auto shutdown
Engine shutdown timer
External emergency engine stop
Fuel filter, extra
High engine idle speed
<b>Tires</b>
875/65R25

## OPTIONAL EQUIPMENT

<b>Electrical System</b>
Headlights, LED
Warning beacon, LED
Working lights, halogen
Working lights, LED
Entrance light
Anti-theft system (pin code)
Rear view camera
Reverse alarm
CAN-BUS interface, extra
<b>Cab</b>
Noise reduction kit (fulfils 2000/14/EC)
Anchorage, operator's manual
Cab heating/ventilation timer
Cable kit, for cab heater 240 V
HEPA cab air filter
Bluetooth radio kit
Rear view mirrors, adjustable, el.heated
Seat belt XXL, non-retractable
Sun blinds, side windows
Universal key
Air suspended, heated, fully adjustable seat
Armrest for operator seat
Headrest for operator seat
Low profile cab

## OPTIONAL EQUIPMENT

<b>Body</b>
Body exhaust heating
Front spillguard, extra
Side extension, 200 mm / 7.9 in
Side extension, light material
Tailgate, overhung, linkage-operated
Tailgate, overhung, wire-operated
Tailgate, underhung
Wear plates, 450 HB
Underground body
<b>Safety</b>
Fire suppression system
Warning triangle
First aid kit and fire extinguisher
Fire extinguisher
Wheel chocks
<b>Service and maintenance</b>
Lube system, standard machine
Lube system, tailgate
Lubrication hose, ground level greasing
Tool kit
<b>Others</b>
Siberian kit -40°C
Arctic oil kit
CareTrack
Fast fuelling system
Jump start connector, NATO -type
Frame extension
Haul Assist - On-Board Weighing
Haul Assist - Tire Pressure Monitoring System

## SELECTION OF VOLVO OPTIONAL EQUIPMENT

Fire suppression system



Fast fuelling



Heavy duty air filter



LED lighting



Entrance light



Wear plates











Not all products are available in all markets. Under our policy of continuous improvement, we reserve the right to change specifications and design without prior notice. The illustrations do not necessarily show the standard version of the machine.



# Solutions for you

Our industry leading machines are just the start of your relationship with Volvo. As your partner, we have developed an extensive range of additional solutions to help you improve uptime, boost productivity and reduce costs.

Our portfolio of products and services is designed to complement your machine's performance and boost your profitability. Simply put, we offer some of the best guarantees, warranties and technological solutions in the industry today. Below are just some examples. Talk to your dealer to find out and discuss the right fit for you!

 Fuel Efficiency Services	 Productivity Services	 Safety Services
 Financial Services	 Uptime Services	 Rental Services
 Volvo Attachments	 Genuine Volvo Parts	 New life Services



## Get the most from your machine

While reliable and efficient machines of course play a vital role in reducing costs, enhancing safety and maximizing productivity, it is ultimately the performance of the operator that really makes the difference. We offer a range of training initiatives to help operators unlock the full capability of their Volvo Articulated Hauler.

## Connected to Uptime

Maximize machine uptime and reduce repair costs with the CareTrack telematic system. Choose to keep track of your machine yourself or let us take care of it with ActiveCare Direct. Our Volvo Uptime Center will provide 24/7 machine monitoring, supplying weekly reports and notifying you should preventive maintenance action be required.

## Control your maintenance costs

Stay on track with planned servicing and keep your asset covered with our range of flexible maintenance and repair agreements.

## Optimize site efficiency

Using Volvo Site Simulation, we can help you make on-site logistics more efficient and lower your cost per tonne. Get recommendations on the best fleet configuration and site set-up to maximize profitability.

## 24h parts delivery guarantee

Maintain productivity and machine uptime with our range of readily available parts, all backed by Volvo warranty – with 24-hour parts delivery guarantee. Only by using Genuine Volvo Parts, can you protect your investment, extend machine life and guarantee long lasting performance.

## Lifetime Frame and Structure Warranty

Quality has long been a hallmark of the Volvo brand. Decades of experience, both in the field and in the laboratory, are today delivering unsurpassed frame and structure durability. We believe in the quality of our products – so much so that Volvo machines come with a Lifetime Frame and Structure Warranty, covering the frame, articulation joint.



**V O L V O**