







Alexander DD-85
Alexander DD-95

							
	Kg	Kg / cm	Hz	kN	mm	kW	lit.
Alexander DD-85	4375	4375	26.0 / 26.0	40 / 50	78 / 65	0.65 / 0.35	60
Alexander DD-95	4825	4825	28.7 / 28.7	40 / 50	82 / 67	0.60 / 0.32	60

Maschinen können mit Sonderzubehör abgebildet sein. Technische Änderungen vorbehalten.
 Machines may be illustrated with extras. Specifications are subject to alteration without prior notice.
 Les machines représentées peuvent comporter des équipements optionnels. Sous réserve de modifications techniques.
 Las máquinas pueden aparecer representadas con extras opcionales. Nos reservamos el derecho de realizar modificaciones técnicas sin previo aviso.



Experience the power of Ingersoll Rand construction and road building equipment, industry-leading support and service. Whatever your job, Ingersoll Rand has the solution from pavers and compactors, portable air compressors, light towers and generators, earthmoving equipment, material handlers, concrete equipment to attachments. Running a successful business takes more than powerful equipment. That's why Ingersoll Rand partners with an experienced global dealer network to stand beside you every step of the way.

www.ingersollrand.com

ABG Allgemeine Baumaschinen-Gesellschaft mbH
 Kuhbrückenstrasse 18 · D-31785 Hameln · Germany
 E-mail ir-abg_info@eu.irco.com · www.ir-abg.com
 tel. +49 (0) 5151-209 0 · fax +49 (0) 5151-209 204

© 2006 Ingersoll-Rand Form #09 - 0406 CPN 80689391



Alexander DD-85 / DD-95



Moving The World Forward

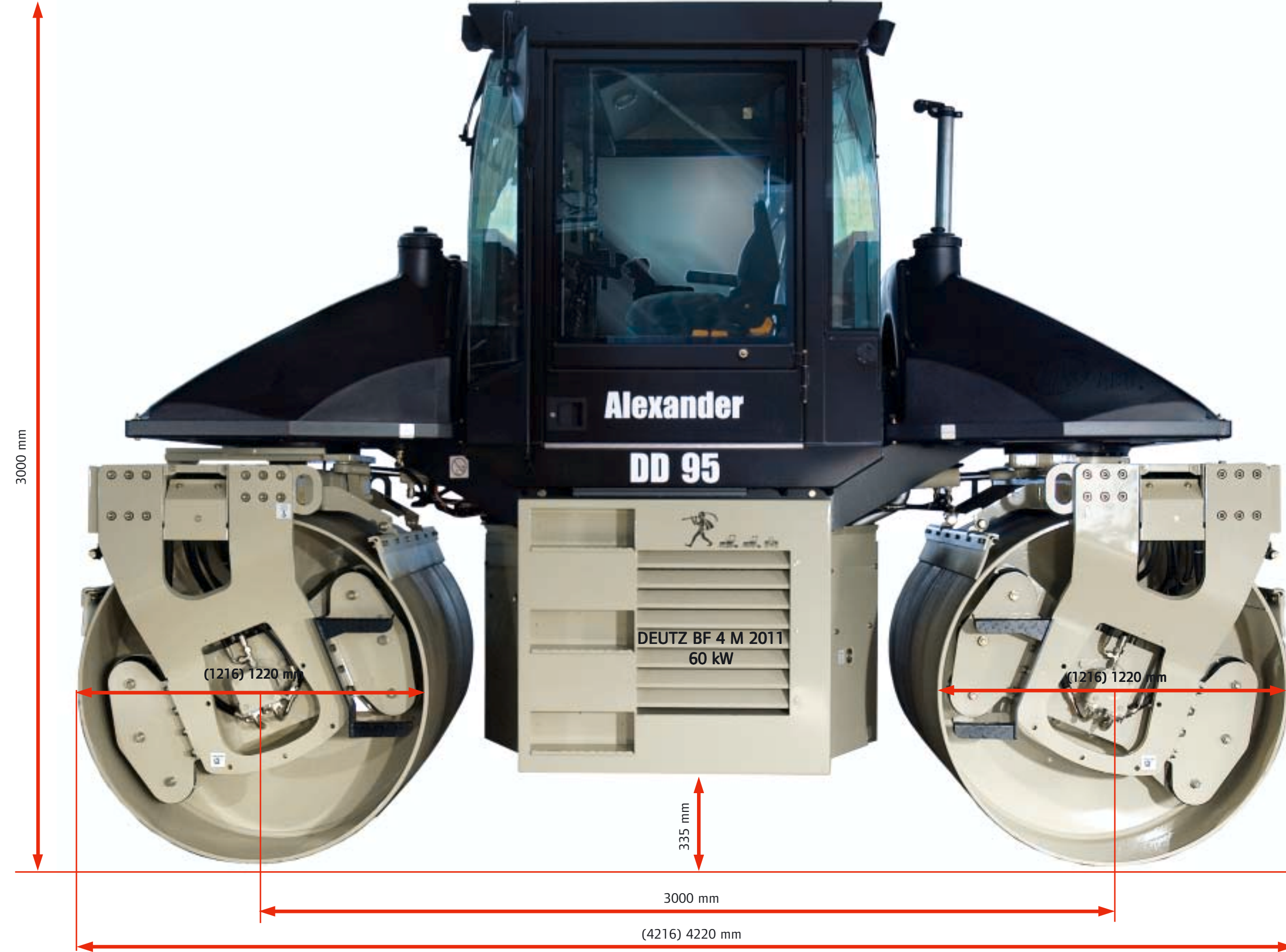

 Alexander DD-85 8750 kg
Alexander DD-95 9650 kg

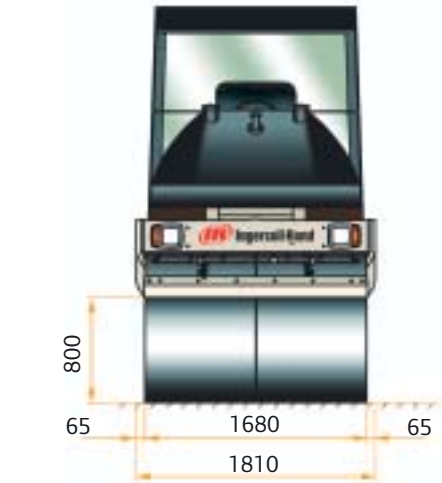

() = Alexander DD-85

