

# VOLVO EXCAVATOR

## EC160B LC EC160B NLC

### MONOBLOCK/2-PIECE BOOM

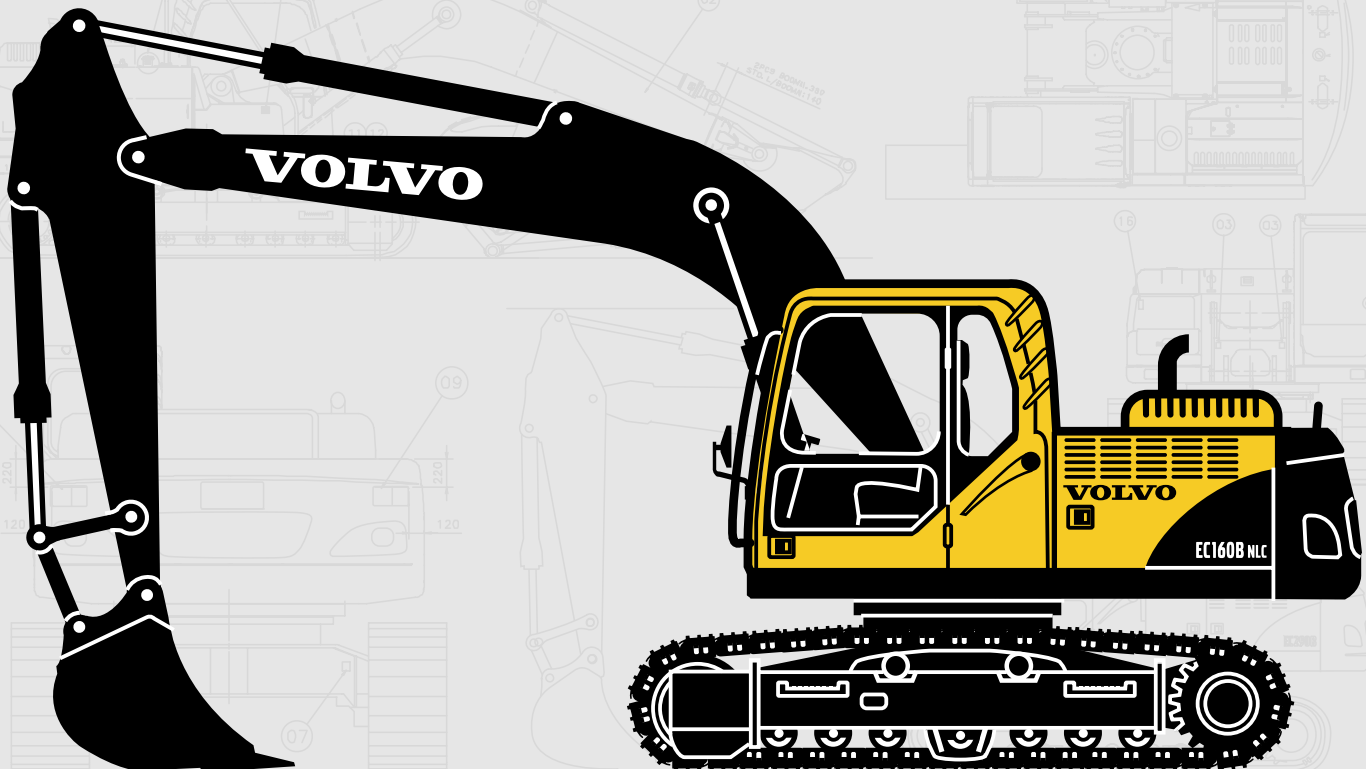

- **Engine power, gross:**  
90 kW (121 hp)
- **Operating weight:**  
LC: 16,6 ~ 18,8 t  
NLC: 16,5 ~ 18,7 t
- **Buckets (SAE):**  
775 ~ 1 225 l
- Turbocharged VOLVO diesel engine with direct injection and charged air cooler meets EU Stage II requirements
- Contronics, Volvo's advanced mode selection system and electronically controlled system
- 2 variable displacement axial piston pumps. Independent and simultaneous movements of the digging equipment are controlled by "Automatic Sensing Work Mode".
- Cab
  - Ergonomic environment for easier operator use
  - Low sound level
  - Filtered air
  - Hydraulic dampening mounts
- Strong digging equipment, produced by robotic welding
- High lifting, breakout and tearout forces for tough digging conditions
- Undercarriage
  - LC: Longer undercarriage for excellent stability
  - NLC: Narrow width for easier transportation
- Auxiliary hydraulic valve is standard
- Prepared for a number of optional items

# VOLVO



## ENGINE

The engine is a turbocharged, 4-stroke diesel engine with water cooling, direct injection and a charged air cooler that easily meets EU Stage II requirements.

The engine has been developed especially for excavator use, providing good fuel economy, low noise levels and a long service life.

**Air Filter:** 3-stage

**Automatic Idling System:** Reduces engine speed to idle when the levers and pedals are not activated resulting in less fuel consumption and low cab noise levels.

### Low-Emission Engine:

Make	VOLVO
Model	D6D EHE2
Power output at	32 r/s (1 900 rpm)
Net (ISO 9249/ DIN 6271)	81 kW (110 ps / 109 hp)
Gross (SAE J1995)	90 kW (122 ps / 121 hp)
Max. torque	542 N·m at 1 450 rpm
No. of cylinders	6
Displacement	5,7 l
Bore	98 mm
Stroke	126 mm



## SLEW SYSTEM

The slew system uses 2 axial piston motors, driving 2 planetary gearboxes for maximum torque. An automatic holding brake and anti-rebound valves are standard.

Max. slew speed ..... 11,9 rpm



## DRIVE

Each track is powered by an automatic two-speed shift travel motor. The track brakes are multi-disc, spring-applied and hydraulic released. The travel motor, brake and planetary gears are well protected within the track frame.

Max. tractive effort ..... 145 kN  
 Max. travel speed ..... 3,0 / 5,6 km/h  
 Gradeability ..... 35° (70%)



## ELECTRICAL SYSTEM

High capacity electrical system that is well-protected. Waterproof double-lock harness plugs are used to secure corrosion free connections. The main relays and solenoid valves are shielded to prevent damage. The master switch is standard.

**Contronics**, provides advanced monitoring of machine functions and important diagnostic information.

Voltage	24 V
Batteries	2 x 12 V
Battery capacity	150 Ah
Alternator	28 V / 80 A



## UNDERCARRIAGE

The undercarriage has a robust X-shaped frame, greased and sealed track chains are standard.

No. of track shoes ..... 2 x 44  
 Link pitch ..... 190 mm  
 Shoe width, triple grouser ..... 500 / 600 / 700 /  
 800 / 900 mm  
 No. of bottom rollers ..... 2 x 7  
 No. of top rollers ..... 2 x 2



## SERVICE REFILL CAPACITIES

Fuel tank	260 l
Hydraulic system, total	245 l
Hydraulic tank	120 l
Engine oil	25 l
Engine coolant	22 l
Slew reduction unit	2,6 l
Travel reduction unit	2 x 5,8 l



## HYDRAULIC SYSTEM

The hydraulic system, also known as the "Automatic Sensing Work Mode", is designed for high-productivity, high-digging capacity, high-maneuvering precision and good fuel economy. The summation system, boom, arm and slew priority along with boom and arm regeneration provide optimum performance.

The following important functions are included in the system:

**Summation system:** Combines the flow of both hydraulic pumps to ensure quick cycle times and high productivity.

**Boom priority:** Gives priority to the boom operation for faster raising when loading or performing deep excavations.

**Arm priority:** Gives priority to the arm operation for faster cycle times in leveling and for increased bucket filling when digging.

**Slew priority:** Gives priority to slew functions for faster simultaneous operations.

**Regeneration system:** Prevents cavitation and provides flow to other movements during simultaneous operations for maximum productivity.

**Power boost:** All digging and lifting forces are increased.

**Holding valves:** Boom and arm holding valves prevent the digging equipment from creeping.

**Power Max:** All function speeds are increased.

### Main pump:

Type ..... 2 x variable displacement axial piston pumps  
Maximum flow ... 2 x 145 l/min

### Pilot pump:

Type ..... Gear pump  
Maximum flow ... 1 x 19 l/min

### Hydraulic motors:

Travel ..... Variable displacement axial piston motor  
with mechanical brake  
Slew ..... Fixed displacement axial piston motor with  
mechanical brake

### Relief valve setting:

Implement ..... 32,4 / 34,3 Mpa  
Travel circuit ..... 34,3 Mpa  
Slew circuit ..... 26,5 Mpa  
Pilot circuit ..... 3,9 Mpa

### Hydraulic cylinders:

Boom ..... 2  
Bore x Stroke .....  $\varnothing 115 \times 1\ 165$  mm  
1st boom of 2-piece boom ..... 2  
Bore x Stroke .....  $\varnothing 115 \times 1\ 165$  mm  
2nd boom of 2-piece boom ..... 1  
Bore x Stroke .....  $\varnothing 160 \times 950$  mm  
Arm ..... 1  
Bore x Stroke .....  $\varnothing 120 \times 1\ 345$  mm  
Bucket ..... 1  
Bore x Stroke .....  $\varnothing 105 \times 1\ 000$  mm



## CAB

The operator's cab has easy access via a wide door opening. The cab is supported on hydraulic dampening mounts to reduce shock and vibration levels. These along with sound absorbing lining provide low noise levels. The cab has excellent all-round visibility. The front windshield can easily slide up into the ceiling and the lower front glass can be removed and stored in the side door.

### Integrated air conditioning and heating system:

The pressurized and filtered cab air is supplied by an automatically controlled fan. The air is distributed throughout the cab from 13 vents.

**Ergonomic operator's seat:** The adjustable seat and joystick console move independently to accommodate the operator.

The seat has nine different adjustments plus a seat belt to for the operator's comfort and safety.

### Sound Level:

Sound level in cab  
according to ISO 6396 ..... LpA 72 dB(A)  
External sound level  
according to ISO 6395  
and EU Directive 2000/14/EC ..... LwA 101 dB(A)



## GROUND PRESSURE

- **LC undercarriage with 5,2 m monoblock boom, 2,6 m arm, 570 l (470 kg) bucket and 2 850 kg counterweight.**

Description	Shoe width	Operating weight	Ground pressure	Overall width
Triple grouser	500 mm	16 580 kg	47,0 kPa	2 700 mm
	600 mm	16 800 kg	39,7 kPa	2 800 mm
	700 mm	17 010 kg	34,4 kPa	2 900 mm
	800 mm	17 230 kg	30,5 kPa	3 000 mm
	900 mm	17 670 kg	27,8 kPa	3 200 mm

- **LC undercarriage dozer blade with 5,2 m monoblock boom, 2,6 m arm, 570 l (470 kg) bucket and 2 850 kg counterweight.**

Description	Shoe width	Operating weight	Ground pressure	Overall width
Triple grouser	500 mm	17 710 kg	50,2 kPa	2 800 mm
	600 mm	17 930 kg	42,4 kPa	2 800 mm
	700 mm	18 140 kg	36,7 kPa	2 900 mm
	800 mm	18 360 kg	32,5 kPa	3 000 mm
	900 mm	18 800 kg	29,6 kPa	3 200 mm

- **NLC undercarriage with 5,2 m monoblock boom, 2,6 m arm, 570 l (470 kg) bucket and 2 850 kg counterweight.**

Description	Shoe width	Operating weight	Ground pressure	Overall width
Triple grouser	500 mm	16 480 kg	46,7 kPa	2 490 mm
	600 mm	16 700 kg	39,5 kPa	2 590 mm
	700 mm	16 910 kg	34,2 kPa	2 690 mm
	800 mm	17 130 kg	30,4 kPa	2 790 mm
	900 mm	17 570 kg	27,7 kPa	2 990 mm

- **NLC undercarriage dozer blade with 5,2 m monoblock boom, 2,6 m arm, 570 l (470 kg) bucket and 2 850 kg counterweight.**

Description	Shoe width	Operating weight	Ground pressure	Overall width
Triple grouser	500 mm	17 610 kg	49,9 kPa	2 590 mm*
	600 mm	17 830 kg	42,1 kPa	2 590 mm
	700 mm	18 040 kg	36,5 kPa	2 690 mm
	800 mm	18 260 kg	32,4 kPa	2 790 mm
	900 mm	18 700 kg	29,5 kPa	2 990 mm

\*Overall width = 2 490 mm, but with dozer the width = 2 590 mm

## MAX. PERMITTED BUCKETS

Note: 1. Bucket size based on ISO 7451, heaped material with a 1:1 angle of repose.  
2. "Max permitted sizes" are for reference only and are not necessarily available from the factory.

- Max. permitted sizes for direct fit buckets:  
LC undercarriage with counterweight 2 850 kg

Description	Unit	5,2 m Boom		
		2,3 m Arm	2,6 m Arm	3,0 m Arm
GP bucket 1,5 t/m <sup>3</sup>	l	1 225	1 150	1 050
GP bucket 1,8 t/m <sup>3</sup>	l	1 050	1 000	925

- Max. permitted sizes for S6 quick fit buckets:  
LC undercarriage with counterweight 2 850 kg

Description	Unit	5,2 m Boom		
		2,3 m Arm	2,6 m Arm	3,0 m Arm
GP bucket 1,5 t/m <sup>3</sup>	l	1 175	1 100	1025
GP bucket 1,8 t/m <sup>3</sup>	l	1 025	950	875

- Max. permitted sizes for S1 quick fit buckets:  
LC undercarriage with counterweight 2 850 kg

Description	Unit	5,2 m Boom		
		2,3 m Arm	2,6 m Arm	3,0 m Arm
GP bucket 1,5 t/m <sup>3</sup>	l	1 150	1 075	1 000
GP bucket 1,8 t/m <sup>3</sup>	l	1 000	950	875

- Max. permitted sizes for direct fit buckets:  
NLC undercarriage with counterweight 2 850 kg

Description	Unit	5,2 m Boom		
		2,3 m Arm	2,6 m Arm	3,0 m Arm
GP bucket 1,5 t/m <sup>3</sup>	l	1 075	1 025	925
GP bucket 1,8 t/m <sup>3</sup>	l	950	850	775

- Max. permitted sizes for S6 quick fit buckets:  
NLC undercarriage with counterweight 2 850 kg

Description	Unit	5,2 m Boom		
		2,3 m Arm	2,6 m Arm	3,0 m Arm
GP bucket 1,5 t/m <sup>3</sup>	l	1 050	975	900
GP bucket 1,8 t/m <sup>3</sup>	l	1 025	875	825

- Max. permitted sizes for S1 quick fit buckets:  
NLC undercarriage with counterweight 2 850 kg

Description	Unit	5,2 m Boom		
		2,3 m Arm	2,6 m Arm	3,0 m Arm
GP bucket 1,5 t/m <sup>3</sup>	l	1 025	875	825
GP bucket 1,8 t/m <sup>3</sup>	l	950	825	775

## DIMENSIONS

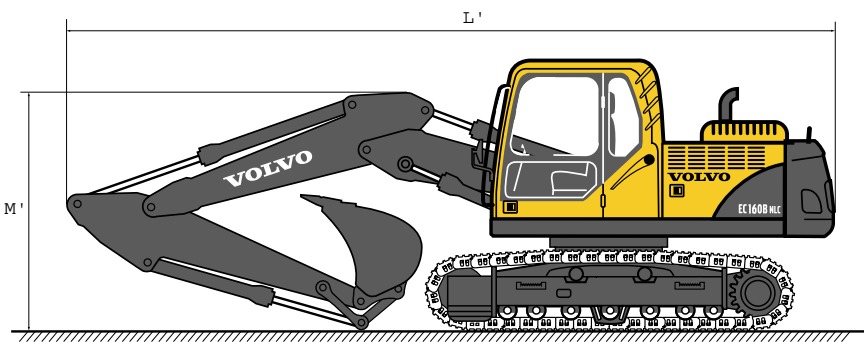
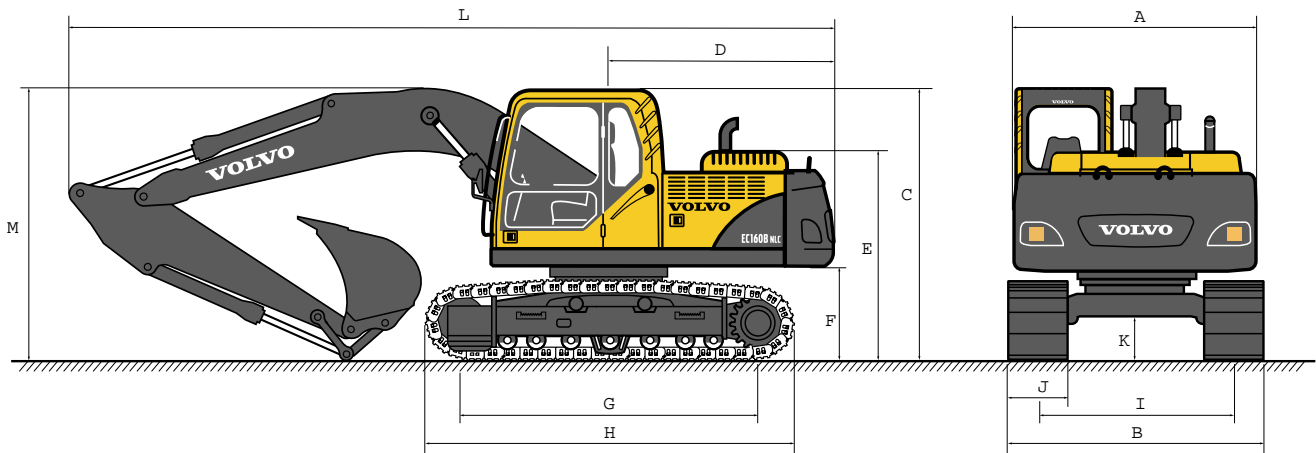

• LC

Description	Unit	5,2 m Boom		
		2,3 m Arm	2,6 m Arm	3,0 m Arm
A. Overall width of superstructure	mm	2 450	2 450	2 450
B. Overall width	mm	2 800	2 800	2 800
C. Overall height of cab	mm	2 900	2 900	2 900
D. Tail slew radius	mm	2 450	2 450	2 450
E. Overall height of engine hood	mm	2 190	2 190	2 190
F. Counterweight clearance *	mm	1 010	1 010	1 010
G. Tumbler length	mm	3 180	3 180	3 180
H. Track length	mm	3 980	3 980	3 980
I. Track gauge	mm	2 200	2 200	2 200
J. Shoe width	mm	600	600	600
K. Min. ground clearance *	mm	460	460	460
L. Overall length	mm	8 780	8 670	8 710
L'. Overall length	mm	8 600	8 520	8 520
M. Overall height of boom	mm	2 980	2 900	3 020
M'. Overall height of boom	mm	2 770	2 770	2 930

\* Without shoe grouser

# DIMENSIONS

## • NLC

Description	Unit	5,2 m Boom		
		2,3 m Arm	2,6 m Arm	3,0 m Arm
A. Overall width of superstructure	mm	2 450	2 450	2 450
B. Overall width	mm	2 490	2 490	2 490
C. Overall height of cab	mm	2 900	2 900	2 900
D. Tail slew radius	mm	2 450	2 450	2 450
E. Overall height of engine hood	mm	2 190	2 190	2 190
F. Counterweight clearance *	mm	1 010	1 010	1 010
G. Tumbler length	mm	3 180	3 180	3 180
H. Track length	mm	3 980	3 980	3 980
I. Track gauge	mm	1 990	1 990	1 990
J. Shoe width	mm	500	500	500
K. Min. ground clearance *	mm	460	460	460
L. Overall length	mm	8 780	8 670	8 710
L'. Overall length	mm	8 600	8 520	8 520
M. Overall height of boom	mm	2 980	2 900	3 020
M'. Overall height of boom	mm	2 770	2 770	2 930

\* Without shoe grouser

## • Boom

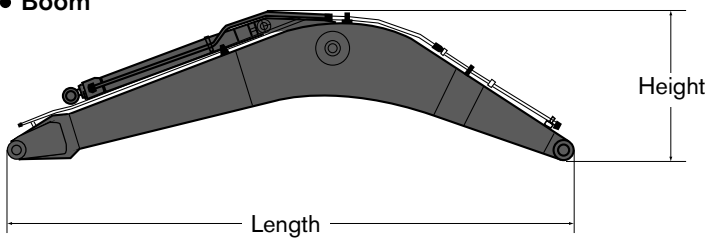

Description	5,2 m	5,0 m 2-piece
Length	5 400 mm	5 200 mm
Height	1 640 mm	1 270 mm
Width	565 mm	565 mm
Weight	1 350 kg	1 600 kg

\* Includes cylinder, pin and piping

## • Arm

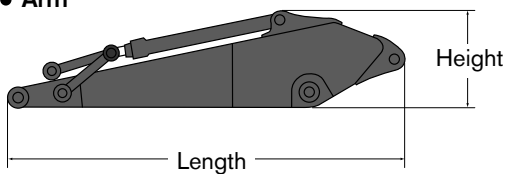

Description	2,3 m	2,6 m	3,0 m
Length	3 240 mm	3 500 mm	3 900 mm
Height	855 mm	855 mm	845 mm
Width	395 mm	395 mm	395 mm
Weight	760 kg	775 kg	840 kg

\* Includes cylinder, piping and linkage

## • Front dozer blade

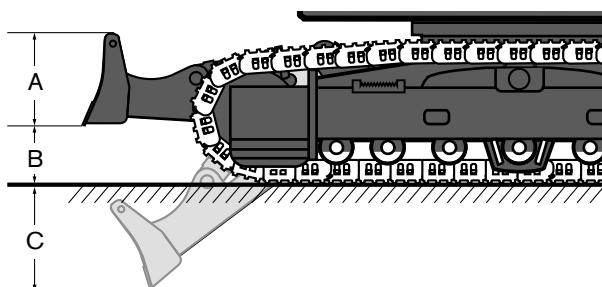

Description	Measurement	
	LC	NLC
A. Height	516 mm	516 mm
Width	2 800 mm	2 590 mm
Weight	600 kg	575 kg
B. Lift height	710 mm	710 mm
C. Digging depth	607 mm	607 mm

## WORKING RANGES & DIGGING FORCES

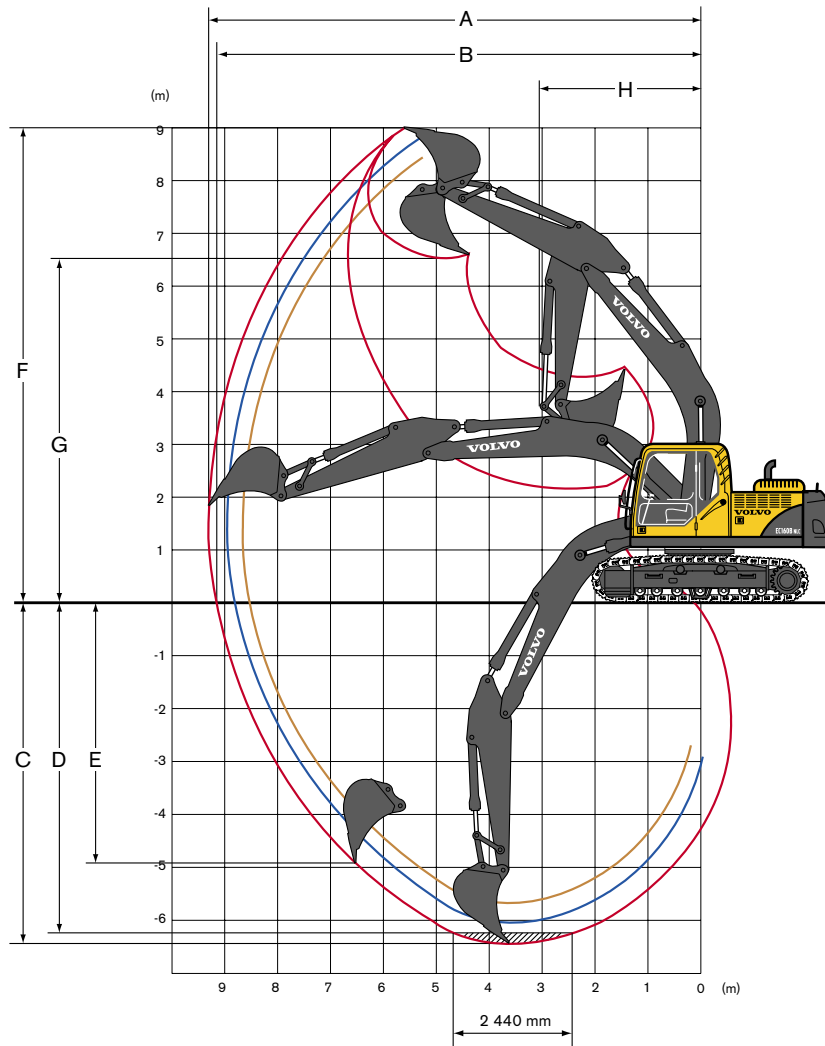

### • 5,2 m monoblock boom with direct fit GP bucket

Description	Unit	5,2 m Boom		
		2,3 m Arm	2,6 m Arm	3,0 m Arm
A. Max. digging reach	mm	8 650	8 970	9 340
B. Max. digging reach on ground	mm	8 490	8 810	9 180
C. Max. digging depth	mm	5 740	6 040	6 440
D. Max. digging depth (2,44 m level)	mm	5 430	5 770	6 200
E. Max. vertical wall digging depth	mm	4 070	4 540	4 960
F. Max. cutting height	mm	8 530	8 790	9 000
G. Max. dumping height	mm	6 110	6 340	6 540
H. Min. front slew radius	mm	3 070	3 070	3 070

### • Digging forces with direct fit bucket

Description	Unit	5,2 m Boom		
		2,3 m Arm	2,6 m Arm	3,0 m Arm
Bucket radius	mm	1 315	1 315	1 315
Breakout force – bucket (Normal / Power boost)	SAE kN	99,2 / 105,2	99,2 / 105,2	99,2 / 105,2
Breakout force – bucket (Normal / Power boost)	ISO kN	111,3 / 118,1	111,3 / 118,1	111,3 / 118,1
Tearout force – arm (Normal / Power boost)	SAE kN	84,9 / 90,1	75,5 / 80,0	68,4 / 72,6
Tearout force – arm (Normal / Power boost)	ISO kN	87,3 / 92,6	77,4 / 82,1	69,9 / 74,1
Rotation angle, bucket	deg	174	174	174



## WORKING RANGES & DIGGING FORCES

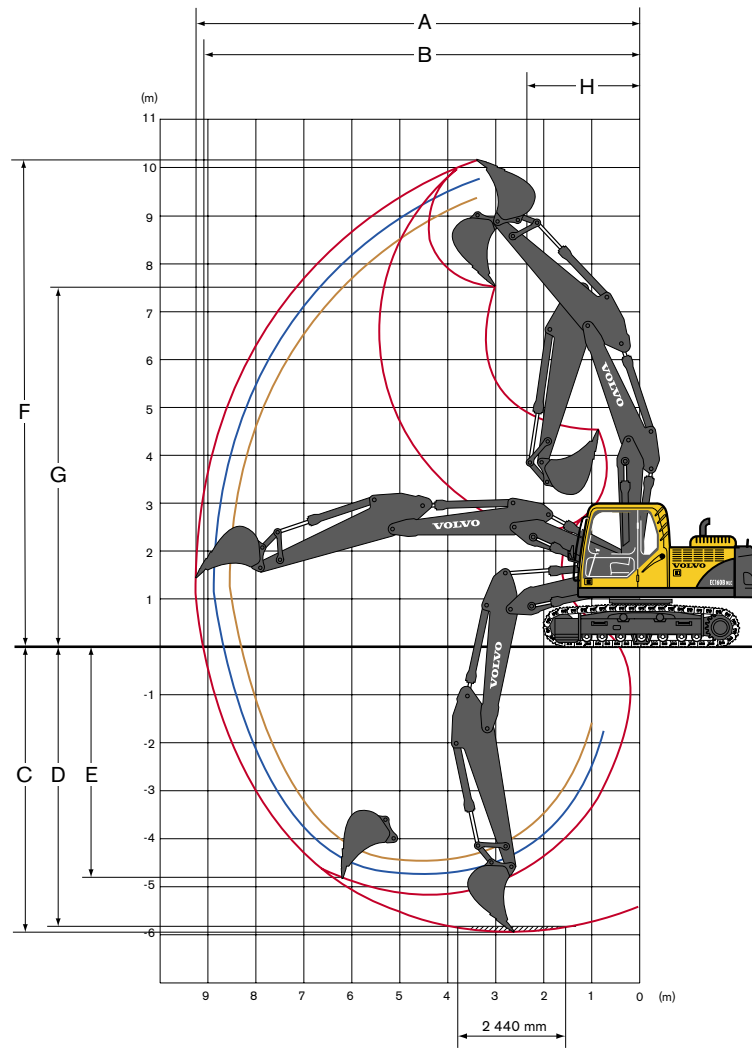

### • 5,0 m 2-piece boom with direct fit bucket

Description	Unit	5,0 m 2-piece boom		
		2,3 m Arm	2,6 m Arm	3,0 m Arm
A. Max. digging reach	mm	8 550	8 870	9 240
B. Max. digging reach on ground	mm	8 380	8 700	9 090
C. Max. digging depth	mm	5 210	5 530	5 930
D. Max. digging depth (2,44 m level)	mm	5 090	5 410	5 810
E. Max. vertical wall digging depth	mm	4 070	4 430	4 830
F. Max. cutting height	mm	9 510	9 820	10 120
G. Max. dumping height	mm	6 920	7 210	7 520
H. Min. front slew radius	mm	2 290	2 250	2 350















### • Digging forces with direct fit bucket

Description	Unit	5,0 m 2-piece boom		
		2,3 m Arm	2,6 m Arm	3,0 m Arm
Bucket radius	mm	1 315	1 315	1 315
Breakout force – bucket (Normal / Power boost)	SAE kN	99,2 / 105,2	99,2 / 105,2	99,2 / 105,2
Breakout force – bucket (Normal / Power boost)	ISO kN	111,3 / 118,1	111,3 / 118,1	111,3 / 118,1
Tearout force – arm (Normal / Power boost)	SAE kN	84,9 / 90,1	75,5 / 80,0	68,4 / 72,6
Tearout force – arm (Normal / Power boost)	ISO kN	87,3 / 92,6	77,4 / 82,1	69,9 / 74,1
Rotation angle, bucket	deg	174	174	174

## LIFTING CAPACITY (At the arm and without bucket)

Note: For lifting capacity including bucket, simply subtract actual weight of the direct fit bucket or the bucket with quick fit from the following values.

### EC160B LC















 Across undercarriage  Along undercarriage	Lifting hook related to ground level	1,5 m		3,0 m		4,5 m		6,0 m		7,5 m		Max. reach			
														Max. mm	
with 600 mm shoe 2 850 kg CWT monoblock boom 5,2 m + arm 2,3 m	6,0 m kg												*4 210	3 680	5 880
	4,5 m kg					*4 670	*4 670	*4 380	3 500				4 110	2 890	6 760
	3,0 m kg					*6 170	5 130	4 830	3 360				3 640	2 540	7 220
	1,5 m kg					7 240	4 800	4 680	3 210				3 470	2 410	7 340
	0 m kg					7 030	4 610	4 560	3 100				3 560	2 450	7 140
	-1,5 m kg			*9 840	8 660	6 980	4 570	4 520	3 070				3 970	2 710	6 590
	-3,0 m kg			*12 170	8 810	7 050	4 640						5 080	3 440	5 590
	-4,5 m kg														
with 600 mm shoe 2 850 kg CWT monoblock boom 5,2 m + arm 2,6 m	6,0 m kg							*3 900	3 600				*3 830	3 340	6 270
	4,5 m kg					*4 300	*4 300	*4 120	3 540				*3 760	2 690	7 100
	3,0 m kg			*9 120	*9 120	*5 810	5 200	*4 770	3 390	3 440	2 400		3 410	2 380	7 540
	1,5 m kg					7 280	4 840	4 690	3 230	3 370	2 340		3 270	2 270	7 650
	0 m kg			*5 100	*5 100	7 040	4 620	4 560	3 110				3 340	2 300	7 460
	-1,5 m kg	*5 250	*5 250	*9 000	8 600	6 960	4 550	4 500	3 050				3 670	2 520	6 940
	-3,0 m kg	*9 380	*9 380	*12 590	8 740	7 010	4 600						4 560	3 100	6 000
	-4,5 m kg			*10 100	9 040								*6 960	5 040	4 350
with 600 mm shoe 2 850 kg CWT monoblock boom 5,2 m + arm 3,0 m	6,0 m kg							*3 450	*3 450				*3 240	3 000	6 720
	4,5 m kg							*3 750	3 560				*3 180	2 460	7 500
	3,0 m kg			*7 710	*7 710	*5 270	5 260	*4 430	3 400	3 440	2 400		3 160	2 200	7 910
	1,5 m kg			*5 140	*5 140	*6 970	4 870	4 700	3 230	3 360	2 320		3 030	2 090	8 020
	0 m kg			*5 570	*5 570	7 030	4 610	4 540	3 080	3 280	2 250		3 080	2 110	7 840
	-1,5 m kg	*4 800	*4 800	*8 430	*8 430	6 910	4 500	4 460	3 010				3 350	2 290	7 350
	-3,0 m kg	*8 160	*8 160	*13 000	8 590	6 930	4 520	4 470	3 020				4 030	2 740	6 470
	-4,5 m kg			*11 010	8 850	7 100	4 670						6 060	4 050	4 990

- Notes:
- Machine in "Fine Mode-F" (Power Boost), for lifting capacities.
  - The above loads are in compliance with SAE J1097 and ISO 10567 Hydraulic Excavator Lifting Capacity Standards.
  - Rated loads do not exceed 87% of hydraulic lifting capacity or 75% of tipping load.
  - Rated loads marked with an asterisk (\*) are limited by hydraulic capacity rather than tipping load.

## LIFTING CAPACITY (At the arm and without bucket)

Note: For lifting capacity including bucket, simply subtract actual weight of the direct fit bucket or the bucket with quick fit from the following values.

### EC160B LC















 Across undercarriage  Along undercarriage	Lifting hook related to ground level	1,5 m		3,0 m		4,5 m		6,0 m		7,5 m		Max. reach		
														Max. mm
with 600 mm shoe 2 850 kg CWT 2-piece boom 5,0 m + arm 2,3 m	7,5 m kg											*5 560	*5 560	4 120
	6,0 m kg					*6 450	5 680					*4 800	3 760	5 740
	4,5 m kg			*7 860	*7 860	*6 990	5 480	4 970	3 450			4 190	2 910	6 640
	3,0 m kg					7 630	5 100	4 820	3 310			3 690	2 540	7 110
	1,5 m kg					7 220	4 740	4 650	3 160			3 520	2 410	7 230
	0 m kg					6 990	4 540	4 530	3 050			3 620	2 460	7 030
	-1,5 m kg			*10 050	8 550	6 950	4 510	4 510	3 030			4 060	2 750	6 470
	-3,0 m kg					*5 350	4 610					*4 090	3 610	5 380
with 600 mm shoe 2 850 kg CWT 2-piece boom 5,0 m + arm 2,6 m	7,5 m kg					*4 790	*4 790					*4 350	*4 350	4 670
	6,0 m kg					*5 550	*5 550	*4 290	3 540			*3 790	3 390	6 140
	4,5 m kg			*5 870	*5 870	*6 360	5 550	5 020	3 500			*3 650	2 700	6 980
	3,0 m kg			*11 810	9 780	7 710	5 170	4 850	3 350			3 450	2 380	7 430
	1,5 m kg					7 270	4 790	4 670	3 170	3 340	2 280	3 300	2 260	7 550
	0 m kg			*5 630	*5 630	7 010	4 550	4 530	3 050			3 380	2 300	7 355
	-1,5 m kg			*9 670	8 490	6 930	4 490	4 490	3 010			3 750	2 540	6 830
	-3,0 m kg					*5 940	4 560					*3 950	3 190	5 860
with 600 mm shoe 2 850 kg CWT 2-piece boom 5,0 m + arm 3,0 m	7,5 m kg					*4 650	*4 650					*3 600	*3 600	5 270
	6,0 m kg					*4 680	*4 680	*4 340	3 600			*3 200	3 030	6 600
	4,5 m kg					*5 140	*5 140	5 060	3 530			*3 080	2 460	7 390
	3,0 m kg			*10 820	10 110	*7 350	5 250	4 880	3 370	3 410	2 350	*3 130	2 190	7 810
	1,5 m kg			*6 320	*6 320	7 330	4 830	4 680	3 180	3 330	2 270	3 050	2 080	7 930
	0 m kg			*6 050	*6 050	7 000	4 540	4 510	3 030	3 260	2 210	3 110	2 110	7 740
	-1,5 m kg			*9 010	8 370	6 880	4 430	4 440	2 960			3 410	2 300	7 240
	-3,0 m kg			*8 880	8 520	*6 560	4 470	4 480	3 000			*3 940	2 800	6 350

- Notes:
1. Machine in "Fine Mode-F" (Power Boost), for lifting capacities.
  2. The above loads are in compliance with SAE J1097 and ISO 10567 Hydraulic Excavator Lifting Capacity Standards.
  3. Rated loads do not exceed 87% of hydraulic lifting capacity or 75% of tipping load.
  4. Rated loads marked with an asterisk (\*) are limited by hydraulic capacity rather than tipping load.

## LIFTING CAPACITY (At the arm and without bucket)

Note: For lifting capacity including bucket, simply subtract actual weight of the direct fit bucket or the bucket with quick fit from the following values.

### EC160B NLC















 Across undercarriage  Along undercarriage	Lifting hook related to ground level	1,5 m		3,0 m		4,5 m		6,0 m		7,5 m		Max. reach			
														Max. mm	
with 500 mm shoe 2 850 kg CWT monoblock boom 5,2 m + arm 2,3 m	6,0 m kg												*4 210	3 270	5 880
	4,5 m kg					*4 670	*4 670	*4 380	3 110				4 070	2 560	6 760
	3,0 m kg					*6 170	4 520	4 780	2 970				3 590	2 240	7 220
	1,5 m kg					7 150	4 190	4 620	2 820				3 430	2 110	7 340
	0 m kg					6 940	4 010	4 500	2 720				3 510	2 150	7 140
	-1,5 m kg			*9 840	7 370	6 890	3 970	4 460	2 680				3 910	2 380	6 590
	-3,0 m kg			*12 170	7 510	6 970	4 030						5 020	3 010	5 590
	-4,5 m kg														
with 500 mm shoe 2 850 kg CWT monoblock boom 5,2 m + arm 2,6 m	6,0 m kg							*3 900	3 210				*3 830	2 970	6 270
	4,5 m kg					*4 300	*4 300	*4 120	3 140				*3 760	2 380	7 100
	3,0 m kg			*9 120	8 350	*5 810	4 580	*4 770	3 000	3 400	2 120		3 370	2 100	7 540
	1,5 m kg					7 200	4 230	4 640	2 840	3 330	2 050		3 230	1 990	7 650
	0 m kg			*5 100	*5 100	6 950	4 020	4 500	2 720				3 290	2 010	7 460
	-1,5 m kg	*5 250	*5 250	*9 000	7 310	6 870	3 950	4 450	2 670				3 630	2 200	6 940
	-3,0 m kg	*9 380	*9 380	*12 590	7 440	6 920	4 000						4 500	2 720	6 000
	-4,5 m kg			*10 100	7 720								*6 960	4 400	4 350
with 500 mm shoe 2 850 kg CWT monoblock boom 5,2 m + arm 3,0 m	6,0 m kg							*3 450	3 250				*3 240	2 660	6 720
	4,5 m kg							*3 750	3 170				*3 180	2 170	7 500
	3,0 m kg			*7 710	*7 710	*5 270	4 640	*4 430	3 010	3 400	2 120		3 120	1 930	7 910
	1,5 m kg			*5 140	*5 140	*6 970	4 260	4 640	2 840	3 310	2 040		2 990	1 830	8 020
	0 m kg			*5 570	*5 570	6 940	4 010	4 480	2 700	3 240	1 970		3 040	1 850	7 840
	-1,5 m kg	*4 800	*4 800	*8 430	7 210	6 820	3 900	4 400	2 620				3 310	2 000	7 350
	-3,0 m kg	*8 160	*8 160	*13 000	7 300	6 840	3 920	4 420	2 640				3 980	2 400	6 470
	-4,5 m kg			*11 010	7 550	7 010	4 060						5 980	3 530	4 990

- Notes:
- Machine in "Fine Mode-F" (Power Boost), for lifting capacities.
  - The above loads are in compliance with SAE J1097 and ISO 10567 Hydraulic Excavator Lifting Capacity Standards.
  - Rated loads do not exceed 87% of hydraulic lifting capacity or 75% of tipping load.
  - Rated loads marked with an asterisk (\*) are limited by hydraulic capacity rather than tipping load.

## LIFTING CAPACITY (At the arm and without bucket)

Note: For lifting capacity including bucket, simply subtract actual weight of the direct fit bucket or the bucket with quick fit from the following values.

### EC160B NLC















 Across undercarriage  Along undercarriage	Lifting hook related to ground level	1,5 m		3,0 m		4,5 m		6,0 m		7,5 m		Max. reach			
														Max. mm	
with 500 mm shoe 2 850 kg CWT 2-piece boom 5,0 m + arm 2,3 m	7,5 m kg												*5 560	*5 560	4 120
	6,0 m kg					*6 450	5 030						*4 800	3 330	5 740
	4,5 m kg			*7 860	*7 860	*6 990	4 840	4 910	3 050				4 140	2 560	6 640
	3,0 m kg					7 550	4 480	4 760	2 920				3 640	2 230	7 110
	1,5 m kg					7 130	4 120	4 590	2 760				3 470	2 100	7 230
	0 m kg					6 900	3 930	4 470	2 660				3 570	2 140	7 030
	-1,5 m kg			*10 050	7 240	6 860	3 900	4 450	2 640				4 010	2 400	6 470
	-3,0 m kg					*5 350	4 000						*4 090	3 150	5 380
with 500 mm shoe 2 850 kg CWT 2-piece boom 5,0 m + arm 2,6 m	7,5 m kg					*4 790	*4 790						*4 350	*4 350	4 670
	6,0 m kg					*5 550	5 110	*4 290	3 140				*3 790	3 000	6 140
	4,5 m kg			*5 870	*5 870	*6 360	4 910	4 960	3 090				*3 650	2 380	6 980
	3,0 m kg			*11 810	8 410	7 630	4 540	4 800	2 950				3 410	2 090	7 430
	1,5 m kg					7 190	4 170	4 610	2 780	3 290	1 990		3 260	1 970	7 550
	0 m kg			*5 630	*5 630	6 920	3 940	4 470	2 660				3 340	2 010	7 355
	-1,5 m kg			*9 670	7 180	6 840	3 880	4 430	2 620				3 710	2 220	6 830
	-3,0 m kg					*5 940	3 950						*3 950	2 780	5 860
with 500 mm shoe 2 850 kg CWT 2-piece boom 5,0 m + arm 3,0 m	7,5 m kg					*4 650	*4 650						*3 600	*3 600	5 270
	6,0 m kg					*4 680	*4 680	*4 340	3 200				*3 200	2 680	6 600
	4,5 m kg					*5 140	4 990	5 000	3 130				*3 080	2 160	7 390
	3,0 m kg			*10 820	8 710	*7 350	4 620	4 820	2 970	3 370	2 060		*3 130	1 910	7 810
	1,5 m kg			*6 320	*6 320	7 240	4 200	4 620	2 780	3 280	1 980		3 010	1 810	7 930
	0 m kg			*6 050	*6 050	6 910	3 930	4 460	2 630	3 220	1 920		3 070	1 830	7 740
	-1,5 m kg			*9 010	7 070	6 790	3 820	4 380	2 570				3 360	2 000	7 240
	-3,0 m kg			*8 880	7 210	*6 560	3 860	4 430	2 610				*3 940	2 430	6 350

- Notes:
1. Machine in "Fine Mode-F" (Power Boost), for lifting capacities.
  2. The above loads are in compliance with SAE J1097 and ISO 10567 Hydraulic Excavator Lifting Capacity Standards.
  3. Rated loads do not exceed 87% of hydraulic lifting capacity or 75% of tipping load.
  4. Rated loads marked with an asterisk (\*) are limited by hydraulic capacity rather than tipping load.

## LIFTING CAPACITY (At the arm and without bucket)

Note: For lifting capacity including bucket, simply subtract actual weight of the direct fit bucket or the bucket with quick fit from the following values.

### EC160B NLC















 Across undercarriage  Along undercarriage	Lifting hook related to ground level	1,5 m		3,0 m		4,5 m		6,0 m		7,5 m		Max. reach			
														Max. mm	
with 600 mm shoe 2 850 kg CWT monoblock boom 5,2 m + arm 2,3 m	6,0 m kg												*4 210	3 310	5 880
	4,5 m kg					*4 670	*4 670	*4 380	3 150				4 120	2 590	6 760
	3,0 m kg					*6 170	4 570	4 850	3 010				3 640	2 270	7 220
	1,5 m kg					7 240	4 240	4 680	2 860				3 480	2 140	7 340
	0 m kg					7 030	4 060	4 560	2 750				3 560	2 180	7 140
	-1,5 m kg			*9 840	7 460	6 980	4 020	4 530	2 720				3 970	2 410	6 590
	-3,0 m kg			*12 170	7 600	7 060	4 090						5 090	3 050	5 590
	-4,5 m kg														
with 600 mm shoe 2 850 kg CWT monoblock boom 5,2 m + arm 2,6 m	6,0 m kg							*3 900	3 240				*3 830	3 010	6 270
	4,5 m kg					*4 300	*4 300	*4 120	3 180				*3 760	2 410	7 100
	3,0 m kg			*9 120	8 450	*5 810	4 630	*4 770	3 030	3 440	2 150		3 420	2 130	7 540
	1,5 m kg					7 290	4 280	4 700	2,870	3 370	2 080		3 270	2 020	7 650
	0 m kg			*5 100	*5 100	7 050	4 070	4 570	2 760				3 340	2 040	7 460
	-1,5 m kg	*5 250	*5 250	*9 000	7 410	6 970	4 010	4 510	2 710				3 680	2 240	6 940
	-3,0 m kg	*9 380	*9 380	*12 590	7 530	7 020	4 050						4 560	2 750	6 000
	-4,5 m kg			*10 100	7 820								*6 960	4 450	4 350
with 600 mm shoe 2 850 kg CWT monoblock boom 5,2 m + arm 3,0 m	6,0 m kg							*3 450	3 280				*3 240	2 700	6 720
	4,5 m kg							*3 750	3 200				*3 180	2 200	7 500
	3,0 m kg			*7 710	*7 710	*5 270	4 690	*4 430	3 050	3 450	2 140		3 160	1 960	7 910
	1,5 m kg			*5 140	*5 140	*6 970	4 310	4 700	2 870	3 360	2 060		3 030	1 860	8 020
	0 m kg			*5 570	*5 570	7 040	4 060	4 550	2 730	3 290	2 000		3 080	1 870	7 840
	-1,5 m kg	*4 800	*4 800	*8 430	7 300	6 920	3 960	4 470	2 660				3 350	2 030	7 350
	-3,0 m kg	*8 160	*8 160	*13 000	7 390	6 930	3 970	4 480	2 670				4 040	2 430	6 470
	-4,5 m kg			*11 010	7 640	7 100	4 110						6 060	3 580	4 990

- Notes:
- Machine in "Fine Mode-F" (Power Boost), for lifting capacities.
  - The above loads are in compliance with SAE J1097 and ISO 10567 Hydraulic Excavator Lifting Capacity Standards.
  - Rated loads do not exceed 87% of hydraulic lifting capacity or 75% of tipping load.
  - Rated loads marked with an asterisk (\*) are limited by hydraulic capacity rather than tipping load.

## LIFTING CAPACITY (At the arm and without bucket)

Note: For lifting capacity including bucket, simply subtract actual weight of the direct fit bucket or the bucket with quick fit from the following values.

### EC160B NLC

 Across undercarriage  Along undercarriage	Lifting hook related to ground level	1,5 m		3,0 m		4,5 m		6,0 m		7,5 m		Max. reach		
														Max. mm
with 600 mm shoe 2 850 kg CWT 2-piece boom 5,0 m + arm 2,3 m	7,5 m kg											*5 560	*5 560	4 120
	6,0 m kg					*6 450	5 090					*4 800	3 360	5 740
	4,5 m kg			*7 860	*7 860	*6 990	4 890	4 980	3 090			4 200	2 600	6 640
	3,0 m kg					7 640	4 530	4 820	2 950			3 690	2 260	7 110
	1,5 m kg					7 230	4 170	4 650	2 800			3 520	2 130	7 230
	0 m kg					7 000	3 980	4 530	2 690			3 620	2 170	7 030
	-1,5 m kg			*10 050	7 340	6 960	3 950	4 510	2 670			4 070	2 430	6 470
	-3,0 m kg					*5 350	4 050					*4 090	3 190	5 380
with 600 mm shoe 2 850 kg CWT 2-piece boom 5,0 m + arm 2,6 m	7,5 m kg					*4 790	*4 790					*4 350	*4 350	4 670
	6,0 m kg					*5 550	5 160	*4 290	3 170			*3 790	3 040	6 140
	4,5 m kg			*5 870	*5 870	*6 360	4 960	5 020	3 130			*3 650	2 410	6 980
	3,0 m kg			*11 870	8 500	7 720	4 600	4 860	2 980			3 460	2 110	7 430
	1,5 m kg					7 280	4 220	4 670	2 820	3 340	2 020	3 310	2 000	7 550
	0 m kg			*5 630	*5 630	7 010	3 990	4 540	2 690			3 390	2 040	7 355
	-1,5 m kg			*9 670	7 280	6 940	3 930	4 490	2 650			3 760	2 250	6 830
	-3,0 m kg					*5 940	4 000					*3 950	2 820	5 860
with 600 mm shoe 2 850 kg CWT 2-piece boom 5,0 m + arm 3,0 m	7,5 m kg					*4 650	*4 650					*3 600	*3 600	5 270
	6,0 m kg					*4 680	*4 680	*4 340	3 230			*3 200	2 710	6 600
	4,5 m kg					*5 140	5 040	5 070	3 160			*3 080	2 190	7 390
	3,0 m kg			*10 820	8 800	*7 350	4 670	4 890	3 000	3 420	2 090	*3 130	1 940	7 810
	1,5 m kg			*6 320	*6 320	7 330	4 260	4 680	2 820	3 330	2 010	3 060	1 840	7 930
	0 m kg			*6 050	*6 050	7 010	3 980	4 520	2 670	3 260	1 950	3 120	1 860	7 740
	-1,5 m kg			*9 010	7 160	6 880	3 880	4 440	2 600			3 410	2 030	7 240
	-3,0 m kg			*8 880	7 300	*6 560	3 910	4 490	2 640			*3 940	2 470	6 350

- Notes:
1. Machine in "Fine Mode-F" (Power Boost), for lifting capacities.
  2. The above loads are in compliance with SAE J1097 and ISO 10567 Hydraulic Excavator Lifting Capacity Standards.
  3. Rated loads do not exceed 87% of hydraulic lifting capacity or 75% of tipping load.
  4. Rated loads marked with an asterisk (\*) are limited by hydraulic capacity rather than tipping load.

## STANDARD EQUIPMENT

### Engine

Turbocharged, 4 stroke diesel engine with water cooling, direct injection and charged air cooler that meets EU Stage II requirements  
3-stage air filter with indicator  
Air intake heater  
Electric engine shut-off  
Fuel filter and water separator  
Fuel filler pump: 50 l/min with automatic shut-off  
Coolant filter  
Alternator, 80 A

### Electric / Electronic control system

Contronics:  
- Advanced mode control system  
- Self-diagnostic system  
Machine status indication  
Engine speed sensing power control  
"Power Max" mode system  
Automatic idling system  
One-touch power boost

Safety stop/start function  
Overload warning device  
Adjustable monitor  
Master switch  
Engine restart prevention circuit  
High capacity halogen lights:  
- Frame mounted 2  
- Boom mounted 2  
Batteries, 2 x 12 V / 150 Ah  
Start motor, 24 V / 4,8 kW

### Hydraulic system

Automatic hydraulic system:  
- Summation system  
- Boom priority  
- Arm priority  
- Slew priority  
Boom and arm regeneration valves  
Slew anti-rebound valves  
Boom and arm holding valves  
Multi-stage filtering system  
Cylinder cushioning  
Cylinder contamination seals  
Hose rupture valve: boom  
Auxiliary hydraulic valve

Straight travel circuit  
Automatic two-speed travel motors  
Hydraulic oil, ISO VG 46

### Superstructure

Access way with handrail  
Tool storage area  
Punched metal anti-slip plates  
Counterweight, 2 850 kg  
Undercover (heavy duty 4,5 mm)

### Cab and interior

Heater & air-conditioner, automatic  
Hydraulic dampening cab mounts  
Adjustable operator seat and joystick control console  
Flexible antenna  
Hydraulic safety lock lever  
Control joystick, with 5 switches each  
Cab, all-weather sound suppressed, includes:  
- Ashtray  
- Cup holder  
- Lighter  
- Door locks

- Tinted glass  
- Floor mat  
- Horn  
- Large storage area  
- Pull-up type front window  
- Removable lower windshield  
- Seat belt  
- Safety glass  
- Windshield wiper with intermittent feature  
- Rain shield, front  
- Sun shield, front, roof, rear  
- Stereo cassette radio  
Anti-vandalism kit assembly preparation  
Master ignition key

### Undercarriage

Hydraulic track adjusters  
Greased and sealed track chain  
Track guards  
Undercover (heavy duty 10 mm)

### Service

Tool kit, daily maintenance

## ALTERNATIVE EQUIPMENT

### Cab and interior

Seat:  
- Fabric seat  
- Fabric seat, with heater  
- Fabric seat, with heater and air suspension

### Track shoes

500 / 600 / 700 / 800 / 900 mm  
track shoes with triple grousers

### Digging equipment

Boom: 5,2 m monoblock  
5,0 m 2-piece  
Arm: 2,3 / 2,6 / 3,0 m

### Undercarriage

LC (Long crawler)  
NLC (Narrow long crawler)

## OPTIONAL EQUIPMENT (Standard in certain markets)

### Engine

Block heater, 120V / 240 V  
Diesel coolant heater  
Tropical cooling kit

### Electric

Extra lamps:  
- Cab-mounted 3, (front 2, rear 1)  
- Counterweight-mounted 1  
Rotating warning beacon  
Travel alarm

### Hydraulic system

Hose rupture valve: dipper arm  
Hydraulic piping  
- Hammer & shears:  
1 pump flow  
2 pump flow  
Additional return filter  
Pump flow control for hammer & shears  
Extra piping for slope & rotator  
- Slope & rotator  
- Grapple  
- Oil leak (drain) line  
- Quick fit piping  
Volvo hydraulic quick-fit, S1, S6 size  
Hydraulic oil, ISO VG 32  
Hydraulic oil, ISO VG 68  
Hydraulic oil, biodegradable 32  
Hydraulic oil, biodegradable 46  
Boom floating function

### Cab and interior

Falling object guard (FOG)  
Cab mounted falling object protective structures (FOPS)  
Safety net for front window  
Lower wiper  
Anti-vandalism kit

### Undercarriage

1 additional track guard each side

### Service

Tool kit, full scale  
Spare parts

All products are not available in all markets. Under our policy of continuous improvement, we reserve the right to change specifications and designs without prior notice. The illustrations do not necessarily show the standard version of the machine.

# VOLVO

Construction Equipment  
www.volvo.com

Ref. No. 21 D 100 0548  
Printed in Sweden 2005.12-1,0  
Volvo, Eskilstuna

English  
EXB