

VOLVO WHEELED EXCAVATOR

# EW210C

19.9 - 22.2 t, 173 hp



**MORE CARE. BUILT IN.**



# VOLVO – A PARTNER TO TRUST.

Trust means knowing your equipment will excel no matter the job, the hour or the conditions. Volvo EW210C wheeled excavators will earn your trust. Dig more, lift more and do more with Volvo's most powerful wheeled excavators. All with the stability you'd expect from a crawler excavator. With that kind of pedigree, the EW210C will rewrite the book on wheeled excavator performance.

Highly mobile. Powerful. Solid. Fuel efficient. Comfortable. The Volvo EW210C is more than a machine. It's a fleet of one.

#### **Volvo: your global, local partner**

Since 1927, Volvo has earned trust for providing solutions with true value. Built on core values of quality, safety and environmental care, Volvo equipment is a leader in construction and transportation. Its extensive lineup of construction machines is complemented by Volvo buses, trucks, aero engines and marine power systems. As the world's largest producer of 9- to 18-liter diesel engines, Volvo delivers class-leading fuel efficiency. That heritage is born anew in the C-Series family of excavators. One shift in the cab of a Volvo excavator and you'll understand why so many count on Volvo as their trusted partner.

#### **A task force from one machine**

Other machines may try to claim the crown, but Volvo C-Series wheeled excavators are arguably the most capable construction machines at work anywhere. So what is an excavator doing making such claims? Watch and see. The EW210C is one machine, but it performs the work of a task force. Digging trenches. Lifting heavy pipe. Craning

concrete traffic barriers. Hammering impacted rock. Setting up trench boxes. Grading. Sawing concrete bridge decks. Pulling storm debris from under bridges.

All that power and ability is anchored by heavy-duty axles to create an exceptionally stable excavator that moves between job sites at up to 30 km/h.

#### **Cab puts the operator in command**

The EW210C's roomy Volvo Care Cab has excellent visibility, high-volume climate control, a see-through roof hatch and repositionable steering column. The responsive controls allow the operator to infinitely adjust hydraulic flow and pressure for attachments without leaving the seat. Fluid levels can be monitored right from the cab.

With such power, mobility, ease of use, comfort and adaptability, the EW210C truly has the power of more. More tools. More tasks. More control. More work done — on less fuel. At the end of the day it adds up to the one thing all contractors want — more profit.





• Power and stability for lifting, craning and carrying.



• Volvo Care Cab delivers commanding visibility.



• All-round excavator and tool-carrier performance.



• Volvo is a sure sign of innovation and quality.



• Extra-duty components deliver reliable, long life.



• Efficient, intelligent Volvo V-ACT engine.

- Rugged, mobile tool carrier efficiently handles the work of several machines.
- Adjust attachment hydraulic flow and pressure right from the cab.
- Cab comfort, clear visibility enhance productivity.
- V-ACT engine has high torque at low revs and superior fuel efficiency.

# A CAB THIS GOOD COULD ONLY COME FROM VOLVO.

Why is the new Volvo C-Series Care Cab so roomy, comfortable and secure? Simple. Volvo knows the excavator operator is that important.

We made the EW210C cab roomy, expanded the cab glass, built in a transparent, openable roof hatch option and made everything from the seat to the steering column easy to customize for just the right fit. We make it easy to do more — in comfort.

## No better place to work

One shift at the controls of the EW210C and an operator will never want to run anything but a Volvo. Operator input is a big part of Volvo cab design, so it's no surprise the EW210C Care Cab is loaded with productivity-enhancing features. It's not only good for the operator, it's a competitive edge for the owner. Productivity and profit start in the cab.

It's easier than ever to be productive — right from the operator's seat. Daily checks of engine oil, coolant, hydraulic oil and filters can be done via the easy-to-read electronic control monitor. No more climbing on the excavator for daily checks.

The optional Volvo CareTrack system works with the machine's diagnostics to track geographic location, usage, fuel consumption, service reminders and more. Using GPS technology, CareTrack makes the information available remotely via computer. CareTrack also offers theft protection by allowing you to limit geographic areas or hours of the day the machine can be operated.

Switching attachments is fast and convenient. The operator can adjust hydraulic flow and pressure settings

from the cab — a major time saver when doing tool-carrier work. Volvo hydraulics provide smooth, comfortable control with low effort from the joysticks. And the ride is smooth, whether roading at full speed or operating in creep mode.

## Visibly superior

Volvo is already known for industry leading cab visibility. Now we've made it even better with more cab glass and a transparent roof hatch that opens via a gas strut. Visibility has been dramatically improved by moving the windshield-wiper motor to the left and the wiper cleans a wider area. The steering column pivots back and forth, so it won't obstruct view to the front. With the two-piece boom retracted, visibility out the right side is clear and unobstructed for travel.

An optional rear-view camera is integrated into the in-cab monitor for extra safety. Digging, lifting or craning, the operator has the cleanest lines of sight, for added confidence and better productivity.

We've relocated the cooling system fan, so the pressurized cab is even quieter. A new viscous-mount suspension cushions the platform from vibration, so long shifts won't mean big fatigue. An improved seat enhances comfort — and significantly reduces whole-body vibration.



• Extra leg and foot room boosts operator comfort.

- Deluxe air-suspension seat (option) with adjustable height, tilt, recline and forward-back settings to easily suit any size operator.
- Joystick consoles adjust up, down, forward and back.
- Forward-reverse switch on right joystick provides superior control, lessens leg fatigue compared with F/R pedal.
- Wider cab with more leg room and foot space.
- Electronic control console allows daily fluid and filter checks right from the cab.
- Generous cab glass enhances industry-leading visibility.
- Transparent, openable roof hatch offers clean sight lines for overhead operations.
- Retractable steering column pivots toward the operator for clean field of view.
- Removable lower front window stows easily in cab door pocket.
- Optional rear camera provides added safety and increased operator confidence.
- New viscous-mount suspension dampens shock and vibration.
- 14-vent climate-control keeps cab air comfortable in any weather.



• Steering column pivots for visibility and comfort.



• Machine controls are all within easy reach.



• Overhead visibility through transparent roof.



# FLEET PRODUCTION — FROM ONE MACHINE.

Every contractor looks for a competitive edge, which is why Volvo built so many into its line of wheeled excavators. The EW210C is a superior tool carrier that performs the work of several machines — at lower cost and higher profit.

With so many options, from buckets and hammers to grapples and clamps, the EW210C is more than a machine. It's a force.

## **One machine, many solutions**

The Volvo EW210C is a true tool commander, engineered with even more power and impressive stability to handle the work of several machines. With a multitude of available attachments and the ability to customize hydraulic flow and pressure right from the cab, the EW210C has the power and quality of a whole fleet — built in.

The stout, solid undercarriage anchors the machine for digging, lifting and precision operations. With robust, wide-spread outriggers and parallel blade, the EW210C can lift as much as a 24-ton crawler excavator. And it won't tear up roadway pavement or mar other sensitive surfaces like crawler tracks.

Versatility starts with the EW210C's boom. The available two-piece boom delivers incredible agility, allowing the excavator to work in tight spaces or perform parallel digging. Geometry of the two-piece boom makes the EW210C perfectly suited for a huge range of tasks, from craning concrete pipes to placing utility poles. The standard monoboom delivers solid performance for digging and lifting applications.

## **Work tools for any task**

Tool-carrier performance of the EW210C is limited only by the needs of the customer. Add a quick fit and tilting, rotating attachment to take machine performance to a smart level. Long reach and fine creep control make this an excellent ditching machine.

Smooth, load-sensing hydraulics deliver the control for asphalt cutting or grading around obstructions. Stability and power help the machine excel at lifting and placing pipes, moving construction materials, or setting concrete traffic barriers. Superior hydraulics can power hammers, grapples, brush cutters and many other attachments.

You can easily arm the EW210C with ditching or trenching buckets, rippers, compactors, augers, mowers, pulverizers — and more.

All of this performance is made more effective by the EW210C's smooth travel at speeds up to 30 km/h. So whether the work is across the job site or across town, the EW210C takes the power where you need it most.





• Power, stability and reach for serious trenching.



• Robust hydraulics for pick-and-place operations.



• Reach and power for dredging and ditching.



• Lift and carry ability rivals that of a 24-ton crawler.



• Optional two-piece boom adds versatility.

- With a range of attachments, do more with one machine.
- Operate off road or on pavement without damaging sensitive surfaces.
- Quick fit makes swapping attachments quick and easy.
- Stabilizer blade and outriggers enhance stability for digging or lifting.
- Extra-duty axles enhance machine stability.
- Comfortable ride whether at full speed or in creep mode.

# VOLVO POWER IS THE HEART OF PERFORMANCE.

To truly understand the advantage of operating a machine with a Volvo power system, you have to experience it. One shift at the controls of the EW210C and you'll know it. It shows in power out of the trench. It shows in the fine control placing pipes or pallets of material. It shows in high torque at low RPMs. It shows in world-class fuel economy. Most importantly, it shows in productivity — and profit.



• Tested, and proven, on job sites all over the world.

## Superior power — with purpose

As the world's leading manufacturer of mid-size diesel engines, Volvo knows power. When it comes to the displacement, torque and hydraulic flow to drive the EW210C, Volvo delivers real multi-function performance.

What gives Volvo power a competitive edge on the job site? Superior components are perfectly integrated with Volvo technology to get the most from every stroke, cycle and shift.

Electronic engine controls optimize hydraulic flow based on engine speed and the demands of the job. Operators have engine modes to match the widest range of tasks. Volvo delivers total power

control, so you're assured of maximum output at any speed.

The advanced Volvo V-ACT engine meets Tier 3/Stage IIIA emissions requirements, so it's easy on the environment. You'll squeeze more from every drop of fuel with V-ACT, which uses new fuel-injection and air-management systems to produce clean combustion and low emissions.

## Robust, harmonized hydraulics

The quieter main pump delivers robust oil flow to hydraulic, travel and swing functions for smooth and responsive performance — especially on combined tool-carrier operations. A higher torque swing motor means faster cycle times when working on slopes or placing loads.

Based on the proven Volvo wheel loader engine and specifically designed for the demands of excavation, the EW210C has more components and parts found in other Volvo equipment. That means better parts availability, lower operating costs and better uptime.

Volvo takes the power even further with VCADS Pro and MATRIS — computerized tools to analyze and manage fuel usage, machine function and utilization. Volvo CareTrack brings the power of satellites to track and manage one machine — or an entire fleet.

## VOLVO'S ENGINE LEADERSHIP SPANS LAND, SEA, SKY AND SPACE

As the world's largest manufacturer of 9-to 18-liter diesel engines, Volvo has unmatched expertise designing power systems that move the world. Volvo engines for Volvo Construction Equipment,

Volvo Aero, Volvo Buses, Volvo Penta and Volvo Trucks define productivity and fuel economy. Our performance has been honed on land, over the sea, across the sky and into space. Leading research and

development keeps all Volvo Group products at the forefront of productivity. So when we say Volvo engines are tested — and proven — you can believe it. Trust in it. It's the real advantage of Volvo Power.







• Custom performance with easy mode control.

• Hydraulics optimize flow based on job demands.

• Improved access behind the cab.



• Engines are built for multi-task performance.

#### High-torque V-ACT engine

- Precision, high-pressure fuel injection system.
- Larger capacity turbocharger.
- Innovative exhaust recirculation.
- High torque at low RPMs.
- Industry-leading fuel economy.

#### Electronic engine control

- Real-time sensors feed data to the engine-management system.
- System optimizes combustion based on sensor feedback.
- Maximum available power directed to hydraulics.

#### Hydraulics with harmony

- Maximum available hydraulic power matched to engine speed.
- Volvo hydraulics ensure the flow is directed to where it's needed.

#### Telematics, machine management

- Volvo CareTrack telematics system harnesses satellites for remote monitoring.
- Track location, operation data, error codes, alarms and more.
- Diagnostics, machine history available from MATRIS and VCADS Pro systems.

# A CLOSE-UP VIEW OF ROLLING COMMAND: INNOVATION NEVER LOOKED SO GOOD.

## MORE SAFETY

- **Safety** is a **core value** at Volvo and it shows in our machines.
- **New design Volvo Care Cab** with operator protective structure.
- **Optional rear camera** provides the operator with more confidence.
- Superstructure above the engine is flat for **excellent rear visibility**.
- **Punched-plate anti-slip steps and walkways** for sure grip.
- **Longer cabin footstep** resists damage and is easily replaced.
- **Low noise levels** in the cab and outside the machine.
- **In-cab switch shuts down engine in an emergency**.
- **Clear, openable roof hatch** for clear views of overhead obstructions.
- **Indicator on quick fit** shows if attachments are locked in place.
- **Fuel-efficient, low-emissions engine** is easy on the environment.
- **Lead-free exterior paint**.
- **Volvo excavators are 95% recyclable**.

## MORE SOLUTIONS

- **Auxiliary hydraulics** power a range of attachments:
  - Grapples
  - Slope buckets
  - Brush cutters
  - Compactors
  - Augers
  - Pile drivers
  - Pulverizers
  - Hammers
  - Tilting, rotating attachments
- **One-touch customization** of attachment hydraulic pressure and flow, activated from joystick button in the cab.
- **Full hammer/shear control** from the cab, including flow control, pressure adjustment and ability to store and recall unlimited attachment presets from the keypad in the cab.
- **Volvo quick fit**.
- Available **tilting & rotating attachment** provides 360-degree attachment rotation, extreme agility.
- Available **two-piece boom** enhances work on cramped sites, aids visibility when roading.





## MORE CAB COMFORT

- **Roomier Volvo Care Cab** with customizable controls and backlit switches.
- **More cab glass** delivers enhanced best-in-class visibility.
- **Pivoting, ergonomic steering column** ensures clean lines of sight.
- **Convenient forward-reverse travel switch** on right joystick.
- **Operator shielded from vibration** by viscous-mounted platform.
- **High-capacity heating and cooling** for comfort in any weather.

## MORE PROFIT

- **World-class Volvo engine** with industry-leading fuel economy.
- **New low-emissions Volvo V-ACT engine.**
- **Proven hydraulics:** optimum power where it's needed.
- **Harmonized power** with oil regeneration and priority features for faster cycles and more productivity per shift.

## MORE QUALITY

- **Specially designed outriggers and stabilizer blade** provide **wide stance** for excellent stability.
- **Extra-duty axles** enhance **stability and durability** for lifting and digging operations.
- **Stabilizer blade** has wide footprint so it **won't damage pavement.**
- **Purpose-built undercarriage** designed for the **most demanding conditions.**
- **Extra-duty boom and arm.**
- **Long wheel base** for stability and smooth ride.

## MORE UPTIME

- **Access walkway behind the cab** provides superior service access.
- **Daily checks done from the cab** using the control monitor.
- **Long-life hydraulic oil** with 5,000-hour change interval.
- Convenient **centralized remote greasing** points.
- **Electronic control unit** monitors and troubleshoots all functions.
- **Easy-to-change cab air filter is located outside the cab.**
- **Cooling system is easier to clean.**
- **Satellite-based CareTrack system** monitors and troubleshoots machine operation, location, error codes and more.

# CUSTOMIZABLE MACHINE OPTIONS GIVE YOU THE POWER TO DO MORE.

Volvo C-Series wheeled excavators have productivity and profit built in, but the story doesn't stop there. Volvo offers a wealth of machine options — from hydraulic kits, work lights, and operator seats to a rear-view camera and cold-weather starting system. Volvo delivers more protection, more comfort, more convenience, more strength — and more options.

## **Electronic climate control**

High-capacity heating, cooling and ventilation with electronic climate control keeps the cab comfortable no matter the weather. A heater with manual control is included standard.

## **Anti-theft system**

A security code must be entered on the instrument panel in order to start the engine. The code can be changed by VCADS-Pro. For repeated starts, the system can be set not to require the code for predetermined time periods.

## **Cab protection with FOG, FOPS**

Falling Object Guard (FOG) and Falling Object Protection Structure (FOPS) provide safety and confidence in tough applications like demolition or quarrying. The front of the FOG tilts on gas struts for easy window cleaning.

## **Hydraulic quick fit**

Expand your excavator's capabilities with a hydraulic quick fit for fast, easy change out of buckets and attachments — right from the cab.

## **Tilting, rotating attachments solution**

A tilting, rotating attachment solution provides incredible versatility, allowing you to rotate 360 degrees and tilt bucket or attachment 40 degrees.

## **Hydraulic kits**

Get the most from hammers, crushers and tilting/rotating attachments with a wide selection of hydraulic kits. Optimize flow and power based on boom and arm

lengths. Available in one- and two-pump-flow configurations to suit job needs.

## **Ergonomic operator seats**

A variety of ergonomic, high-performance seats include advanced air-suspension models for extreme comfort. All seats are fully adjustable to fit any size operator.

## **Wrist-control joysticks**

Volvo's low-effort, wrist-control joysticks deliver smooth and even performance that lessens operator fatigue and increases productivity. Wrist control joysticks with proportional-control switches are also available.

## **Engine coolant heater**

The diesel-driven engine coolant heater eases start-ups in cold weather while simultaneously warming the cab. Heating times are adjustable, and the system can be pre-set to engage automatically.

## **Work lights, rotating beacon**

Increase visibility with rear-facing halogen lights on the counterweight, at cab roof and front-facing lights on both sides of the boom. A rotating amber beacon makes the machine more visible on the job site, and when moving the machine on the road.

## **Rear-view camera**

The in-cab LCD monitor provides clear rear views for reverse travel and slewing operations, giving the operator confidence and boosting job-site safety.

## **Twin or single tires**

Choose from single or twin tires to match terrain and job-site conditions.





**Electronic climate control**



**Anti-theft system**



**FOG, FOPS cab protection**



**Volvo quick fit**



**Tilting/rotating attachments solution**



**Hydraulic kits**



**Suspension seats**

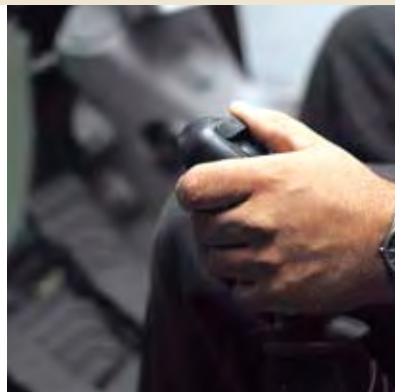

**Proportional-control joysticks**



**Diesel coolant heater with timer**

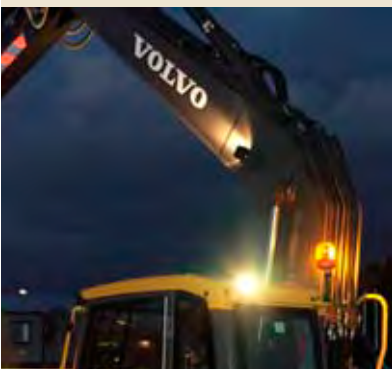

**Extra halogen lamps, beacon**



**Rearview camera**



**Twin tires or single tires**

# SPECIFICATIONS

## Engine

The next-generation Volvo diesel engine uses Volvo Advanced Combustion Technology (V-ACT) to deliver lower emissions and maintain superior performance and fuel efficiency. The EU Stage IIIa compliant engine uses precise, high-pressure fuel injectors, turbo charger, air to air intercooler and electronic engine controls to optimize machine performance.

<b>Engine</b>	Volvo D6E EEE3
<b>Power out at</b>	31,6 r/s (1 900 rpm)
<b>Gross (SAE J1995)</b>	127 kW (173 metric hp)
<b>Net (ISO 9249, DIN 6271)</b>	120 kW (163 metric hp)
<b>Max. torque at 1400 rpm</b>	730 Nm
<b>No. of cylinders</b>	6
<b>Displacement</b>	5,7 l
<b>Bore</b>	98 mm
<b>Stroke</b>	126 mm

## Electrical system

High-capacity electrical system that is well protected. Waterproof double-lock harness plugs are used to secure corrosion-free connections. The main relays and solenoid valves are shielded to prevent damage. The master switch is standard.

<b>Voltage</b>	24 V
<b>Battery</b>	2 x 12 V
<b>Battery capacity</b>	2 x 140 Ah
<b>Alternator</b>	28 V / 80 A
<b>Alternator rating</b>	2 240 W

## Cab

New-design Volvo Care Cab with operator protective structure, large and roomy interior, more leg room and foot space. One way travel pedal with rocker switch control (F-N-R) on the right joystick. One-touch release for digging brake pedal. Audio system with remote control. 3 cup holders, 3 outlets, independently adjustable joystick consoles.

Excellent all-round visibility provided by maximized cab class, transparent roof hatch, 2-piece sliding door window and long-stroke, easy to adjust and narrow steering column. The liftable front windshield can easily be stored in the inside roof space and clipped in position. The removable lower front glass can be stored in the side door pocket. Interior lighting consists of one reading light and one light with timer.

The pressurized and filtered cab air is supplied by a 14-vent climate-control providing fast defrosting and high cooling and heating performance. Viscous/spring mounted suspension cushions protect the operator from vibrations. Deluxe air-suspension seat with adjustable seat suspension, height, tilt, recline and forward-backward settings.

Adjustable, easy to read 6.4" LCD color monitor provides real time information of machine functions

and important diagnostic information and is switchable to rear view camera monitor (option).

Sound level:

<b>In cab, acc. to ISO 6396</b>	70 LpA dB(A)
<b>External, acc. to ISO 6395</b>	103 LwA dB(A)
<b>(Directive 2000/14/EC)</b>	

## Undercarriage

**Drive train:** One big variable axial-piston motor on the two-step Power Shift gearbox gives power to front and rear axles, both with hub reductions.

**Framework:** All-welded robust torsion box frame

**Wheels:** Alternative single and twin wheels available.

**Front axle:** Robust excavator axle with automatic or operator controlled front axle oscillation lock. Oscillating  $\pm 9^\circ$  (with mudguards  $\pm 7^\circ$ ).

<b>Twin wheels</b>	10,00–20
<b>Max. tractive force (net)</b>	115,4 kN
<b>Travel speed:</b>	
<b>on road</b>	20,0/25,0/30,0 km/h
<b>off road</b>	5,0/6,4/7,4 km/h
<b>creep</b>	3,2 km/h
<b>Min. turning radius</b>	8,15 m

## Brakes

**Service brakes:** servo-hydraulically manoeuvred self-adjusting wet multidiscs with two separate brake circuits.

**Parking brake:** negative wet disc in gear housing, spring applied and pressure released.

**Digging brake:** service brake with mechanical lock system.

**Security system:** The 2-circuit travel brakes are supplied with two accumulators in the event of failure in the service brake system.

## Total machine weights

Machine with 2,45 m dipper arm, quick fit S1, 630 kg/830 l bucket.

<b>Dozer blade front and outriggers rear</b>	21 160* kg / 21 860** kg / 21 260*** kg
<b>Dozer blade rear excl. outriggers</b>	19 900* kg / 20 600** kg / 20 000*** kg
<b>Front and rear outriggers</b>	21 500* kg / 22 200** kg / 21 600*** kg

\*Machine with 5,6 m monoblock boom;

CWT 4 500 kg (axle load <12 t)

\*\*Machine with 5,5 m 2-piece boom;

CWT 4 500 kg (axle load >12 t)

\*\*\*Machine with 5,5 m 2-piece boom;

CWT 3 900 kg (axle load <12 t)

## Service refill capacities

<b>Fuel tank</b>	335 l
<b>Hydraulic system, total</b>	330 l
<b>Hydraulic tank</b>	165 l
<b>Engine oil</b>	25 l
<b>Engine coolant</b>	27 l
<b>Transmission</b>	2,5 l
<b>Axle differential:</b>	
<b>Front axle</b>	9,5 l
<b>Rear axle</b>	14,5 l
<b>Final drive, wet disc type</b>	4 x 2,5 l

## Hydraulic system

Closed-centre load sensing hydraulic system with pressure compensated valves. Load independence of movements. Flow sharing feature, combined with a high flow electronically controlled pump (power regulation). The system gives superior manoeuvrability and fast movements, for optimal working result and economy.

The following working modes are included in the system:

**Parking mode (P):** Parking position for optimal safety.

**Travel mode (T):** Engine speed is controlled by travel pedal stroke for low fuel consumption and noise.

**Working mode (W):** Full working flow with adjustable engine rpm for normal working and best speed utilisation.

**Customer mode (C):** Operator can set proper oil flow in accordance with job conditions.

**Power Boost:** All digging and lifting forces are increased.

Hydraulic pumps:

<b>Max. flows:</b>	
<b>Main pump</b> (type low noise axial piston pump)	399 l/min
<b>Brake + steering pump</b> (type low noise gear pump)	36,1 l/min
<b>Servo pump</b> (type low noise gear pump)	14,0 l/min
<b>Hydraulic oil cooling fan + pilot pump</b> (type gear pump)	46,0 l/min
<b>Max. pressure:</b>	
<b>Implements</b>	32,5/36 MPa
<b>Travel system</b>	36 MPa
<b>Pilot System</b>	3,5 MPa

## Slew system

The superstructure is slewed by the means of an axial piston motor with a planetary reduction gear without oil service.

Automatic slew holding brake and anti-rebound valve are standard.

<b>Max. slew speed</b>	9,0 rpm
<b>Max. slew torque</b>	76,6 kNm

## Dimensions

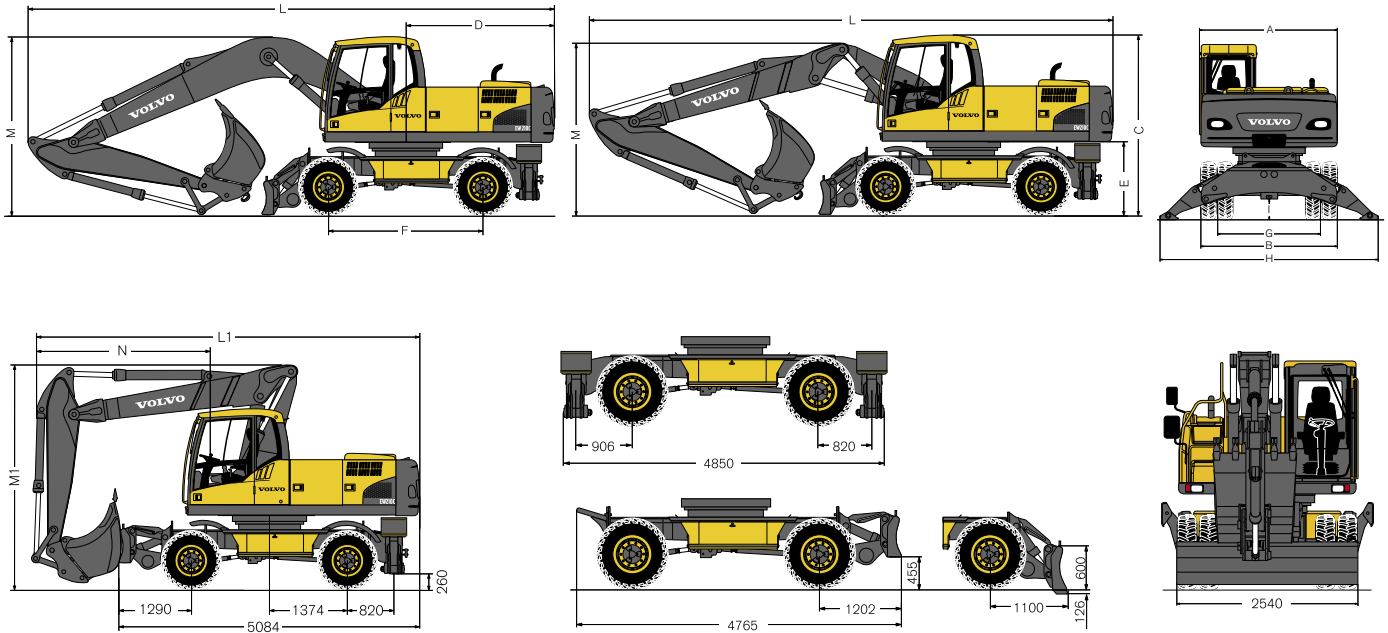

Description	Unit	5,6 m	5,5 m
		Monoblock boom	2-piece boom
A. Overall width of superstructure	mm	2 490	2 490
B. Overall width	mm	2 510	2 510
C. Overall height of cab	mm	3 170	3 170
D. Tail slew radius	mm	2 650	2 650
E. Counterweight clearance	mm	1 290	1 290
F. Wheel base	mm	2 750	2 750
G. Tread	mm	1 912	1 912
H. Outrigger width (front or rear)	mm	3 995	3 995
I. Min. ground clearance	mm	380	380

Description	Unit	5,6 m Monoblock boom				5,5 m 2-piece boom			
		2,45 m	2,6 m	2,9 m	3,2 m	2,45 m	2,6 m	2,9 m	3,2 m
L. Overall length	mm	9 355	9 375	9 370	9 350*	9 280	9 285	9 360	9 135*
M. Overall height of boom	mm	3 075	3 180	3 450	3 650*	3 035	3 065	3 045	3 480*
L1. Overall length	mm					6 835	6 720	6 735	6 900*
M1. Overall height of boom	mm					4 000	4 000	4 000	4 000*
N. Front overhang	mm					3 130	3 015	3 030	3 160*

\* grab arm, without clam shell bucket

## Working ranges & digging forces

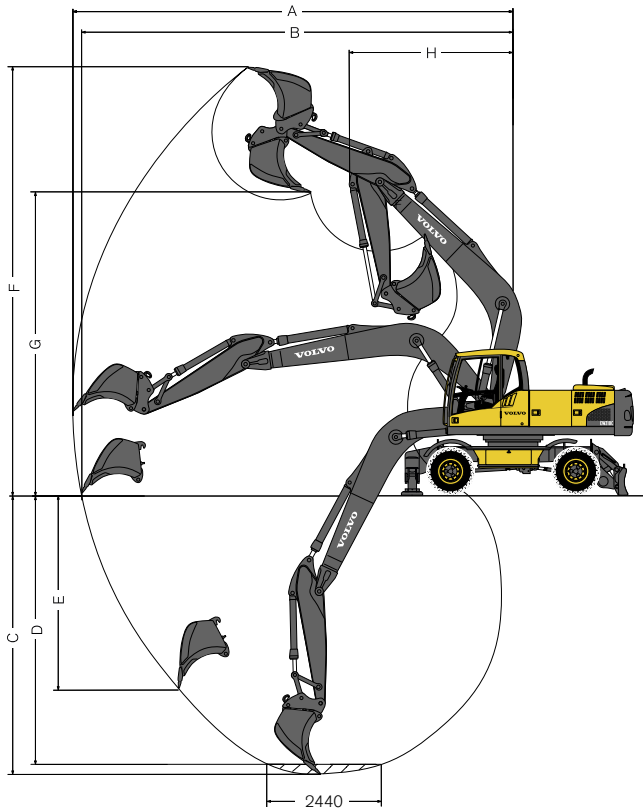

Monoblock boom 5,6 m  
and dipper arm 2,45 m, 2,6 m, 2,90 m

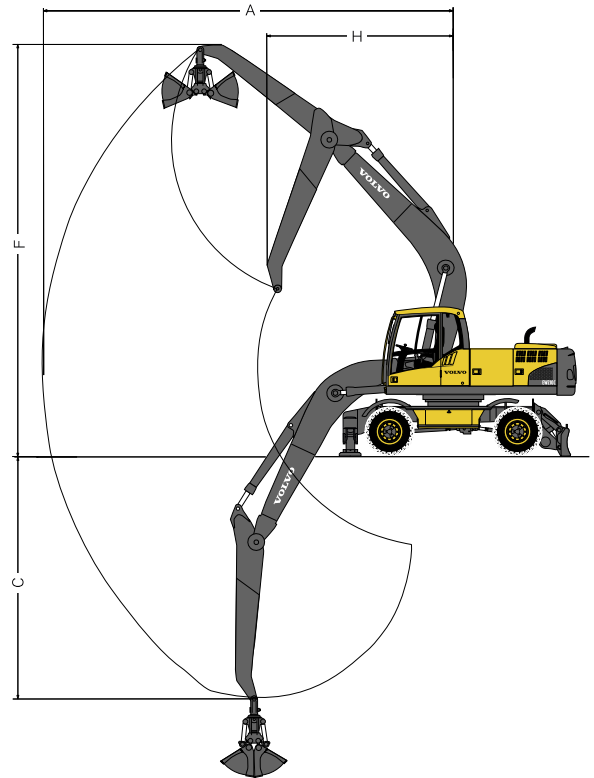

Monoblock boom 5,6 m  
and grab arm 3,2 m

Description	Unit	Monoblock boom			
		2,45 m arm	2,6 m arm	2,90 m arm	3,2 m Grab arm
A. Max. digging reach	mm	9 640	9 770	10 050	8 860
B. Max. digging reach on ground	mm	9 450	9 590	9 870	
C. Max. digging depth	mm	6 180	6 330	6 630	5 350
D. Max. digging depth (2 440 mm level)	mm	5 970	6 130	6 440	
E. Max. vertical wall digging depth	mm	4 390	4 530	4 810	
F. Max. cutting height	mm	9 370	9 440	9 590	8 630
G. Max. dumping height	mm	6 570	6 640	6 780	
H. Min. front slew radius	mm	3 590	3 580	3 560	4 090
<b>Digging forces with direct fit bucket</b>					
Bucket radius	mm	1 399	1 399	1 399	
Breakout force - bucket	(SAE/ISO) kN	124,2/142,7	124,2/142,7	124,2/142,7	
Tearout force	(SAE/ISO) kN	113,9/117,7	109,6/ 113,1	101,8/ 104,8	
Rotation angle, bucket	°	180°	180°	180°	
<b>Max. recommended sizes for direct fit buckets</b>					
GP-Bucket (1,5 t/m <sup>3</sup> )	l	1 125	1 100	1 050	
GP-Bucket (1,8 t/m <sup>3</sup> )	l	1 000	975	925	
<b>Max. recommended sizes for quick fit buckets</b>					
SQF GP-Bucket (1,5 t/m <sup>3</sup> )	l	1 025	1 000	950	
SQF GP-Bucket (1,8 t/m <sup>3</sup> )	l	900	875	825	
UQF GP-Bucket (1,5 t/m <sup>3</sup> )	l	1000	975	925	
UQF GP-Bucket (1,8 t/m <sup>3</sup> )	l	900	875	825	

Note: 1. Bucket size based on SAE-J296, heaped material with a 1:1 angle of repose.  
2. "Max recommended sizes" are for reference only and are not necessarily available from the factory.



## Working ranges & digging forces

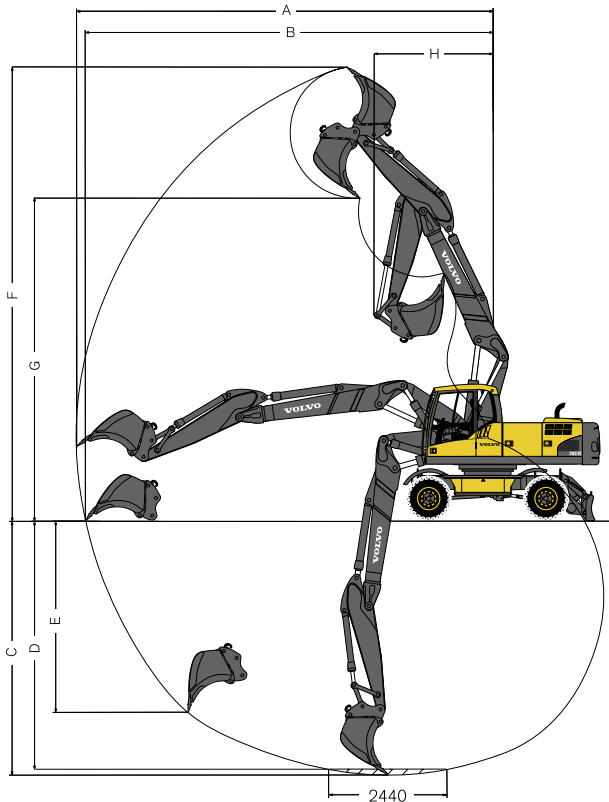

2-piece boom 5,5 m  
and dipper arm 2,45 m, 2,6 m, 2,90 m

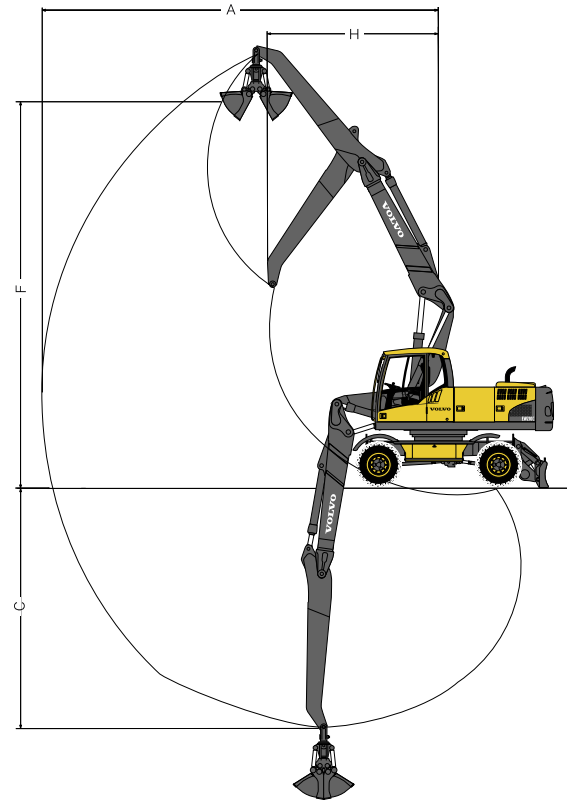

2-piece boom 5,5 m  
and grab arm 3,2 m

Description	Unit	2-piece boom			
		2,45 m arm	2,6 m arm	2,90 m arm	3,2 m Grab arm
A. Max. digging reach	mm	9 640	9 780	10 060	8 850
B. Max. digging reach on ground	mm	9 450	9 590	9 880	
C. Max. digging depth	mm	6 050	6 200	6 500	5 240
D. Max. digging depth (2 440 mm level)	mm	5 920	6 100	6 405	
E. Max. vertical wall digging depth	mm	4 580	4 720	5 000	
F. Max. cutting height	mm	10 670	10 790	11 020	9 870
G. Max. dumping height	mm	7 530	7 640	7 870	
H. Min. front slew radius	mm	2 630	2 675	2 770	3 590

Digging forces with direct fit bucket					
Bucket radius		mm	1 399	1 399	1 399
Breakout force - bucket	(SAE/ISO)	kN	124,2 / 142,7	124,2 / 142,7	124,2 / 142,7
Tearout force	(SAE/ISO)	kN	113,9 / 117,7	109,6 / 113,1	101,8 / 104,8
Rotation angle, bucket		°	180°	180°	180°

Max. recommended sizes for direct fit buckets					
GP-Bucket (1,5 t/m <sup>3</sup> )	(CWT 3 900 kg/4 500 kg)	l	1 000 / 1 100	950 / 1 075	900 / 1 025
GP-Bucket (1,8 t/m <sup>3</sup> )	(CWT 3 900 kg/4 500 kg)	l	875 / 975	850 / 950	800 / 900

Max. recommended sizes for quick fit buckets					
SQF GP-Bucket (1,5 t/m <sup>3</sup> )	(CWT 3 900 kg/4 500 kg)	l	900 / 1 000	875 / 975	825 / 925
SQF GP-Bucket (1,8 t/m <sup>3</sup> )	(CWT 3 900 kg/4 500 kg)	l	775 / 900	750 / 875	725 / 825
UQF GP-Bucket (1,5 t/m <sup>3</sup> )	(CWT 3 900 kg/4 500 kg)	l	875 / 1 000	850 / 975	800 / 900
UQF GP-Bucket (1,8 t/m <sup>3</sup> )	(CWT 3 900 kg/4 500 kg)	l	775 / 875	750 / 850	700 / 800

Note: 1. Bucket size based on SAE-J296, heaped material with a 1:1 angle of repose.  
2. "Max recommended sizes" are for reference only and are not necessarily available from the factory.











## Lifting capacity

At the arm end, without bucket and quick fit. Unit: 1000 kg.

For lifting capacity including bucket/quick fit, simply subtract actual weight of those parts from the following values.

Counterweight 4 500 kg.

 Across under-carriage  Along under-carriage	Arm end (bucket pivot) related to ground level	Reach from machine centre (u = support up/d = support down)																								
		1,5 m		3,0 m		4,5 m		6,0 m		7,5 m		Max. reach														
		u	d	u	d	u	d	u	d	u	d	u	d	u	d	u	d	Max. m								
 5,6 m mono-block boom 2,9 m dipper arm Front and rear outriggers	9,0 m																									
	7,5 m								3,8	5,1*	5,1*	5,1*					3,6	4,1*	4,1*	4,1*	6,2					
	6,0 m								3,8	5,4*	5,4*	5,4*					2,7	3,8*	3,8*	3,8*	7,4					
	4,5 m								3,7	6,0*	5,5	6,0*	2,6	5,3	3,9	5,6*	2,3	3,8*	3,4	3,8*	8,1					
	3,0 m							5,2	9,1*	8,1	9,1*	3,4	7,0*	5,3	7,0*	2,5	5,1	3,8	6,0*	2,0	3,9*	3,1	3,9*	8,4		
	1,5 m							4,7	10,9*	7,6	10,9*	3,2	7,0	5,0	7,9*	2,3	5,0	3,7	6,4*	1,9	4,2	3,0	4,2*	8,5		
	0,0 m					6,5*	6,5*	6,5*	6,5*	4,4	10,7	7,3	11,7*	3,0	6,8	4,8	8,5*	2,2	4,9	3,6	6,7*	2,0	4,2	3,1	4,7*	8,3
	-1,5 m	7,6*	7,6*	7,6*	7,6*	7,8	11,1*	11,1*	11,1*	4,3	10,6	7,2	11,6*	3,0	6,7	4,8	8,5*	2,2	4,9	3,5	6,5*	2,1	4,6	3,3	5,7*	7,8
	-3,0 m	12,1*	12,1*	12,1*	12,1*	8,0	15,0*	14,3	15,0*	4,4	10,6*	7,2	10,6*	3,0	6,7	4,8	7,8*					2,5	5,5	4,0	6,3*	6,9
-4,5 m					8,3	11,4*	11,4*	11,4*	4,6	8,2*	7,4	8,2*									3,5	6,3*	5,6	6,3*	5,5	
 5,6 m mono-block boom 3,2 m arm for grab Front and rear outriggers	9,0 m																									
	7,5 m																				3,4	5,6*	4,9	5,6*	6,8	
	6,0 m												4,1	5,4*	5,4*	5,4*	2,9	5,4*	4,2	5,4*	2,7	5,2	3,9	5,2*	7,8	
	4,5 m												4,0	6,0*	5,8	6,0*	2,8	5,5	4,1	5,6*	2,3	4,5	3,4	5,1*	8,5	
	3,0 m								5,5	8,9*	8,4	8,9*	3,7	6,9*	5,5	6,9*	2,7	5,4	4,0	6,0*	2,1	4,2	3,1	5,2*	8,8	
	1,5 m								5,0	10,8*	7,9	10,8*	3,5	7,3	5,3	7,9*	2,6	5,2	3,9	6,5*	2,0	4,1	3,1	5,5*	8,9	
	0,0 m								4,7	10,9	7,5	11,9*	3,3	7,0	5,1	8,6*	2,5	5,1	3,8	6,9*	2,0	4,2	3,1	5,9*	8,7	
	-1,5 m					8,0	9,7*	9,7*	9,7*	4,5	10,8	7,4	11,9*	3,2	6,9	5,0	8,8*	2,4	5,1	3,7	6,9*	2,2	4,5	3,3	6,1*	8,2
	-3,0 m	10,6*	10,6*	10,6*	10,6*	8,1	15,7*	14,4	15,7*	4,6	10,8	7,4	11,1*	3,2	6,9	5,0	8,2*					2,5	5,2	3,8	6,2*	7,4
-4,5 m					8,4	12,6*	12,6*	12,6*	4,7	9,1*	7,6	9,1*	3,3	6,3*	5,1	6,3*					3,3	6,1*	5,1	6,1*	6,1	
 5,6 m mono-block boom 2,45 m dipper arm Rear dozer blade	9,0 m																									
	7,5 m																				3,9	4,2	5,1*	5,1*	5,6	
	6,0 m												3,5	3,8	5,4	5,9*					2,8	3,0	4,3	4,7*	6,9	
	4,5 m								5,2	5,6	7,7*	7,7*	3,4	3,7	5,3	6,4*	2,4	2,5	3,7	5,7*	2,3	2,5	3,6	4,6*	7,6	
	3,0 m								4,7	5,1	7,6	9,7*	3,2	3,4	5,0	7,3*	2,3	2,4	3,6	6,2*	2,0	2,2	3,2	4,8*	8,0	
	1,5 m								4,3	4,7	7,1	11,3	3,0	3,2	4,8	8,1*	2,2	2,3	3,5	6,5	1,9	2,1	3,1	5,2*	8,1	
	0,0 m								4,1	4,5	6,9	11,8*	2,8	3,1	4,6	8,6*	2,1	2,3	3,4	6,4	2,0	2,1	3,2	5,9*	7,9	
	-1,5 m					7,4	8,2	11,9*	11,9*	4,1	4,4	6,9	11,4*	2,8	3,0	4,6	8,4*					2,1	2,3	3,5	6,5*	7,3
	-3,0 m					7,5	8,3	13,7*	13,7*	4,1	4,5	7,0	10,0*	2,8	3,1	4,6	7,3*					2,6	2,8	4,3	6,7*	6,4
-4,5 m									4,4	4,8	6,9*	6,9*									4,1	4,4	6,3*	6,3*	4,8	
 5,6 m mono-block boom 2,6 m dipper arm Rear dozer blade	9,0 m																									
	7,5 m																				3,7	4,0	4,7*	4,7*	5,8	
	6,0 m												3,6	3,8	5,4	5,7*					2,7	2,9	4,1	4,4*	7,0	
	4,5 m								5,3	5,7	7,4*	7,4*	3,4	3,7	5,3	6,3*	2,4	2,6	3,7	5,8*	2,2	2,4	3,5	4,3*	7,8	
	3,0 m								4,8	5,2	7,7	9,5*	3,2	3,4	5,0	7,2*	2,3	2,5	3,6	6,1*	2,0	2,1	3,2	4,5*	8,1	
	1,5 m								4,3	4,7	7,2	11,2*	3,0	3,2	4,8	8,0*	2,2	2,3	3,5	6,5*	1,9	2,0	3,0	4,8*	8,2	
	0,0 m								4,1	4,5	6,9	11,8*	2,8	3,1	4,6	8,5*	2,1	2,3	3,4	6,4	1,9	2,1	3,1	5,5*	8,0	
	-1,5 m					7,4	8,1	11,6*	11,6*	4,1	4,4	6,9	11,5*	2,8	3,0	4,5	8,4*					2,1	2,3	3,4	6,4*	7,5
	-3,0 m					7,5	8,3	13,8	14,2*	4,1	4,5	6,9	10,2*	2,8	3,0	4,6	7,5*					2,5	2,7	4,1	6,6*	6,6
-4,5 m									4,3	4,7	7,2	7,4*									3,8	4,1	6,2	6,3*	5,0	
 5,6 m mono-block boom 2,9 m dipper arm Rear dozer blade	9,0 m																									
	7,5 m												3,6	3,9	5,1*	5,1*					3,4	3,6	4,1*	4,1*	6,2	
	6,0 m												3,6	3,9	5,4*	5,4*					2,5	2,7	3,8*	3,8*	7,4	
	4,5 m												3,5	3,7	5,3	6,0*	2,4	2,6	3,7	5,6*	2,1	2,3	3,3	3,8*	8,1	
	3,0 m								4,9	5,3	7,8	9,1*	3,2	3,5	5,1	7,0*	2,3	2,5	3,6	6,0*	1,9	2,0	3,0	3,9*	8,4	
	1,5 m								4,4	4,8	7,2	10,9*	3,0	3,2	4,8	7,9*	2,2	2,4	3,5	6,4*	1,8	1,9	2,9	4,2*	8,5	
	0,0 m					6,5*	6,5*	6,5*	6,5*	4,1	4,5	6,9	11,7*	2,8	3,1	4,6	8,5*	2,1	2,3	3,4	6,4	1,8	2,0	2,9	4,7*	8,3
	-1,5 m	7,6*	7,6*	7,6*	7,6*	7,3	8,1	11,1*	11,1*	4,0	4,4	6,9	11,6*	2,7	3,0	4,5	8,5*	2,0	2,2	3,3	6,4	1,9	2,1	3,2	5,7*	7,8
	-3,0 m	12,1*	12,1*	12,1*	12,1*	7,4	8,2	13,7	15,0*	4,1	4,5	6,9	10,6	2,8	3,0	4,6	7,8*					2,3	2,5	3,8	6,4*	6,9
-4,5 m					7,7	8,5	11,4*	11,4*	4,3	4,6	7,1	8,2*									3,3	3,6	5,4	6,3*	5,5	
 5,6 m mono-block boom 3,2 m arm for grab Rear dozer blade	9,0 m																									
	7,5 m																				3,2	3,4	4,7	5,6*	6,8	
	6,0 m												3,9	4,2	5,4*	5,4*	2,7	2,9	4,0	5,4*	2,5	2,7	3,7	5,2*	7,8	
	4,5 m												3,7	4,0	5,5	6,0*	2,6	2,8	4,0	5,6*	2,1	2,3	3,3	5,1*	8,5	
	3,0 m								5,2	5,6	8,1	8,9*	3,5	3,7	5,3	6,9*	2,5	2,7	3,9	6,0*	2,0	2,1	3,0	5,2*	8,8	
	1,5 m								4,7	5,0	7,5	10,8*	3,2	3,5	5,1	7,9*	2,4	2,6	3,7	6,5*	1,9	2,0	2,9	5,2*	8,8	
	0,0 m								4,4	4,7	7,2	11,9*	3,1	3,3	4,9	8,6*	2,3	2,5	3,6	6,7	2,0	2,0	3,0	5,3	8,7	
	-1,5 m					7,4	8,2	9,7*	9,7*	4,2	4,6	7,1	11,9*	3,0	3,2	4,7	8,8*	2,2	2,4	3,5	6,6	2,0	2,2	3,2	5,8	8,2
	-3,0 m	10,6*	10,6*	10,6*	10,6*	7,6	8,3	13,8	15,7*	4,3	4,6	7,1	11,1*	3,0	3,2	4,7	8,2*					2,3	2,5	3,7	6,2*	7,4
-4,5 m					7,8	8,6	12,6*	12,6*	4,4	4,8	7,2	9,1*	3,1	3,3	4,9	6,3*					3,1	3,3	4,8	6,1*	6,1	









Notes: 1. Working pressure with Power Boost = 36 MPa.  
 2. The above values are in compliance with ISO standard 10 567. They do not exceed 87 % of hydraulic lifting capacity or 75 % of tipping load, with the machine on firm, level ground.  
 3. Load capacities marked with an asterisk (\*) are limited by machine's hydraulic lifting capacity rather than tipping load.

## Lifting capacity

At the arm end, without bucket and quick fit. Unit: 1000 kg.

For lifting capacity including bucket/quick fit, simply subtract actual weight of those parts from the following values.

Counterweight 3 900 kg, axle load <12 t

 Across under-carriage  Along under-carriage	Arm end (bucket pivot) related to ground level	Reach from machine centre (u = support up / d = support down)														Max. reach m								
		1,5 m		3,0 m		4,5 m		6,0 m		7,5 m		Max. reach												
		u	d	u	d	u	d	u	d	u	d	u	d	u	d		u	d						
 5,5 m 2-piece boom 2,45 m dipper arm Front dozer blade Rear outriggers	9,0 m																7,0*	7,0*	7,0*	7,0*	3,3			
	7,5 m						5,5*	5,5*	5,5*	5,5*								3,8	5,2*	5,2*	5,2*	5,6		
	6,0 m						5,6	5,7*	5,7*	5,7*	3,5	5,6*	5,2	5,6*				2,7	4,6	4,1	4,7*	6,9		
	4,5 m			9,6	9,7*	9,7*	9,7*	5,2	7,1*	7,1*	7,1*	3,3	5,7	5,1	6,1*	2,3	4,0	3,5	5,7*	2,2	3,8	3,4	4,5*	7,6
	3,0 m						4,6	8,5	7,4	9,1*	3,1	5,5	4,8	6,9*	2,2	3,9	3,4	6,0*	1,9	3,5	3,0	4,6*	8,0	
	1,5 m						4,1	7,9	6,8	10,9*	2,8	5,2	4,5	7,8*	2,1	3,7	3,3	6,4*	1,8	3,3	2,9	4,9*	8,1	
	0,0 m						3,9	7,6	6,5	11,6*	2,7	5,0	4,4	8,4*	2,0	3,7	3,2	6,6*	1,8	3,4	3,0	5,5*	7,9	
	-1,5 m			7,0	11,5*	11,5*	11,5*	3,8	7,6	6,5	11,5*	2,6	4,9	4,3	8,4*				2,0	3,8	3,3	6,5*	7,3	
-3,0 m							3,9	7,7	6,6	10,4*	2,7	5,0	4,4	7,5*				2,5	4,6	4,0	6,8*	6,4		
-4,5 m																								
 5,5 m 2-piece boom 2,6 m dipper arm Front dozer blade Rear outriggers	9,0 m																	6,3*	6,3*	6,3*	6,3*	3,7		
	7,5 m						5,2*	5,2*	5,2*	5,2*									3,6	4,8*	4,8*	4,8*	5,9	
	6,0 m						5,5*	5,5*	5,5*	5,5*	3,5	5,4*	5,2	5,4*					2,6	4,4*	3,9	4,4*	7,1	
	4,5 m			9,2*	9,2*	9,2*	9,2*	5,2	6,9*	6,9*	6,9*	3,3	5,8	5,1	5,9*	2,3	4,0	3,5	5,6*	2,1	3,7	3,3	4,2*	7,8
	3,0 m						4,7	8,6	7,4	8,9*	3,1	5,5	4,8	6,8*	2,2	3,9	3,4	5,9*	1,9	3,4	3,0	4,3*	8,1	
	1,5 m						4,2	8,0	6,8	10,7*	2,9	5,2	4,5	7,7*	2,1	3,7	3,3	6,3*	1,8	3,3	2,9	4,6*	8,2	
	0,0 m						3,9	7,7	6,6	11,6*	2,7	5,0	4,4	8,3*	2,0	3,7	3,2	6,6*	1,8	3,3	2,9	5,1*	8,0	
	-1,5 m			7,0	11,2*	11,2*	11,2*	3,8	7,6	6,5	11,5*	2,6	4,9	4,3	8,4*				2,0	3,6	3,2	6,0*	7,5	
-3,0 m							3,9	7,7	6,6	10,5*	2,7	5,0	4,3	7,7*				2,4	4,4	3,9	6,7*	6,6		
-4,5 m																								
 5,5 m 2-piece boom 2,9 m dipper arm Front dozer blade Rear outriggers	9,0 m																		5,3*	5,3*	5,3*	5,3*	4,3	
	7,5 m						4,8*	4,8*	4,8*	4,8*	3,5	5,2*	5,2*	5,2*					3,3	4,2*	4,2*	4,2*	6,3	
	6,0 m						5,1*	5,1*	5,1*	5,1*	3,4	5,1*	5,1*	5,1*					2,4	3,9*	3,7	3,9*	7,4	
	4,5 m			8,1*	8,1*	8,1*	8,1*	5,3	6,4*	6,4*	6,4*	3,4	5,6*	5,1	5,6*	2,3	4,0	3,6	5,3*	2,0	3,5	3,1	3,8*	8,1
	3,0 m						4,8	8,5*	7,5	8,5*	3,1	5,5	4,9	6,6*	2,2	3,9	3,4	5,7*	1,8	3,2	2,8	3,8*	8,4	
	1,5 m						4,2	8,0	6,9	10,4*	2,9	5,3	4,6	7,5*	2,1	3,8	3,3	6,2*	1,7	3,1	2,7	4,0*	8,5	
	0,0 m						3,9	7,7	6,6	11,5*	2,7	5,0	4,4	8,2*	2,0	3,7	3,2	6,5*	1,7	3,2	2,8	4,4*	8,3	
	-1,5 m			6,9	10,7*	10,7*	10,7*	3,8	7,6	6,5	11,6*	2,6	4,9	4,3	8,4*	1,9	3,6	3,2	6,5*	1,8	3,4	3,0	5,2*	7,8
-3,0 m			7,1	15,7*	12,9	15,7*	3,9	7,6	6,5	10,8*	2,6	5,0	4,3	7,9*				2,2	4,1	3,6	6,4*	6,9		
-4,5 m																								
 5,5 m 2-piece boom 3,2 m arm for grab Front dozer blade Rear outriggers	9,0 m						5,4*	5,4*	5,4*	5,4*									4,9	5,8*	5,8*	5,8*	5,0	
	7,5 m											3,8	5,0*	5,0*	5,0*					3,1	5,1	4,5	5,4*	6,8
	6,0 m											3,8	5,0*	5,0*	5,0*	2,6	4,3	3,9	5,2*	2,4	4,0	3,6	5,3*	7,8
	4,5 m							5,7	6,2*	6,2*	6,2*	3,7	5,6*	5,4	5,6*	2,6	4,3	3,8	5,3*	2,0	3,5	3,1	5,1*	8,5
	3,0 m											3,4	5,8	5,1	6,6*	2,4	4,2	3,7	5,8*	1,9	3,2	2,9	5,1*	8,8
	1,5 m											3,1	5,5	4,8	7,6*	2,3	4,0	3,5	6,3*	1,8	3,1	2,8	5,3*	8,9
	0,0 m							4,2	7,9	6,8	11,6*	2,9	5,3	4,6	8,4*	2,2	3,9	3,4	6,7*	1,8	3,2	2,8	5,7*	8,7
	-1,5 m							4,0	7,8	6,7	11,9*	2,8	5,1	4,5	8,7*	2,1	3,8	3,4	6,8*	1,9	3,4	3,0	6,1*	8,2
-3,0 m			7,2	15,4*	13,1	15,4*	4,0	7,8	6,7	11,3*	2,8	5,1	4,5	8,3*				2,2	3,9	3,5	6,2*	7,4		
-4,5 m																								
 5,5 m 2-piece boom 2,45 m dipper arm Front and rear outriggers	9,0 m																		7,0*	7,0*	7,0*	7,0*	3,3	
	7,5 m						5,5*	5,5*	5,5*	5,5*										3,8	5,2*	5,2*	5,2*	5,6
	6,0 m						5,6	5,7*	5,7*	5,7*	3,5	5,6*	5,3	5,6*						2,7	4,7*	4,2	4,7*	6,9
	4,5 m			9,7	9,7*	9,7*	9,7*	5,2	7,1*	7,1*	7,1*	3,4	6,1*	5,2	6,1*	2,3	4,9	3,6	5,7*	2,2	4,5*	3,5	4,5*	7,6
	3,0 m						4,7	9,1*	7,5	9,1*	3,1	6,9	4,9	6,9*	2,2	4,8	3,5	6,0*	1,9	4,3	3,1	4,6*	8,0	
	1,5 m						4,2	10,3	7,0	10,9*	2,9	6,6	4,7	7,8*	2,1	4,7	3,4	6,4*	1,8	4,2	3,0	4,9*	8,1	
	0,0 m						3,9	10,0	6,7	11,6*	2,7	6,4	4,5	8,4*	2,0	4,6	3,3	6,6*	1,9	4,3	3,1	5,5*	7,9	
	-1,5 m			7,1	11,5*	11,5*	11,5*	3,9	10,0	6,7	11,5*	2,6	6,3	4,4	8,4*				2,1	4,7	3,4	6,5*	7,3	
-3,0 m							4,0	10,1	6,7	10,4*	2,7	6,4	4,5	7,5*				2,5	5,9	4,1	6,8*	6,4		
-4,5 m																								
 5,5 m 2-piece boom 2,6 m dipper arm Front and rear outriggers	9,0 m																		6,3*	6,3*	6,3*	6,3*	3,7	
	7,5 m						5,2*	5,2*	5,2*	5,2*										3,6	4,8*	4,8*	4,8*	5,9
	6,0 m						5,5*	5,5*	5,5*	5,5*	3,5	5,4*	5,4	5,4*						2,6	4,4*	4,0	4,4*	7,1
	4,5 m			9,2*	9,2*	9,2*	9,2*	5,3	6,9*	6,9*	6,9*	3,4	5,9*	5,2	5,9*	2,3	5,0	3,6	5,6*	2,1	4,2*	3,4	4,2*	7,8
	3,0 m						4,7	8,9*	7,6	8,9*	3,1	6,8*	4,9	6,8*	2,2	4,8	3,5	5,9*	1,9	4,2	3,1	4,3*	8,1	
	1,5 m						4,2	10,4	7,0	10,7*	2,9	6,6	4,7	7,7*	2,1	4,7	3,4	6,3*	1,8	4,1	2,9	4,6*	8,2	
	0,0 m						4,0	10,1	6,7	11,6*	2,7	6,4	4,5	8,3*	2,0	4,6	3,3	6,6*	1,8	4,2	3,0	5,1*	8,0	
	-1,5 m			7,0	11,2*	11,2*	11,2*	3,9	10,0	6,7	11,5*	2,6	6,3	4,4	8,4*				2,0	4,6	3,3	6,0*	7,5	
-3,0 m							4,0	10,1	6,7	10,5*	2,7	6,4	4,5	7,7*				2,4	5,6	4,0	6,7*	6,6		
-4,5 m																								

Notes:

- Working pressure with Power Boost = 36 MPa.
- The above values are in compliance with ISO standard 10 567. They do not exceed 87 % of hydraulic lifting capacity or 75 % of tipping load, with the machine on firm, level ground.
- Load capacities marked with an asterisk (\*) are limited by machine's hydraulic lifting capacity rather than tipping load.











## Lifting capacity

At the arm end, without bucket and quick fit. Unit: 1000 kg.

For lifting capacity including bucket/quick fit, simply subtract actual weight of those parts from the following values.

Counterweight 4 500 kg.

 Across under-carriage  Along under-carriage	Arm end (bucket pivot) related to ground level	Reach from machine centre (u = support up / d = support down)														Max. reach								
		1,5 m		3,0 m		4,5 m		6,0 m		7,5 m		Max. reach												
		u	d	u	d	u	d	u	d	u	d	u	d	u	d		u	d	u	d	m			
 5,5 m 2-piece boom 2,45 m dipper arm Front dozer blade Rear outriggers	9,0 m																		7,0*	7,0*	7,0*	7,0*	3,3	
	7,5 m																			4,1	5,2*	5,2*	5,2*	5,6
	6,0 m																			2,9	4,7*	4,4	4,7*	6,9
	4,5 m																			9,7*	9,7*	9,7*	9,7*	7,6
	3,0 m																			5,6	7,1*	7,1*	7,1*	8,0
	1,5 m																			5,0	9,1	7,9	9,1*	8,1
	0,0 m																			4,5	8,5	7,3	10,9*	7,9
	-1,5 m																			3,1	5,6	4,9	7,8*	7,9
	-3,0 m																			3,4	5,9	5,2	6,9*	7,3
-4,5 m																			2,3	4,0	3,7	6,0*	6,4	
 5,5 m 2-piece boom 2,6 m dipper arm Front dozer blade Rear outriggers	9,0 m																		7,0*	7,0*	7,0*	7,0*	3,3	
	7,5 m																			4,1	5,2*	5,2*	5,2*	5,6
	6,0 m																			2,9	4,7*	4,4	4,7*	6,9
	4,5 m																			9,7*	9,7*	9,7*	9,7*	7,6
	3,0 m																			5,6	7,1*	7,1*	7,1*	8,0
	1,5 m																			5,0	9,1	7,9	9,1*	8,1
	0,0 m																			4,5	8,5	7,3	10,9*	7,9
	-1,5 m																			3,1	5,6	4,9	7,8*	7,9
	-3,0 m																			3,4	5,9	5,2	6,9*	7,3
-4,5 m																			2,3	4,0	3,7	6,0*	6,4	
 5,5 m 2-piece boom 2,9 m dipper arm Front dozer blade Rear outriggers	9,0 m																		7,0*	7,0*	7,0*	7,0*	3,3	
	7,5 m																			4,1	5,2*	5,2*	5,2*	5,6
	6,0 m																			2,9	4,7*	4,4	4,7*	6,9
	4,5 m																			9,7*	9,7*	9,7*	9,7*	7,6
	3,0 m																			5,6	7,1*	7,1*	7,1*	8,0
	1,5 m																			5,0	9,1	7,9	9,1*	8,1
	0,0 m																			4,5	8,5	7,3	10,9*	7,9
	-1,5 m																			3,1	5,6	4,9	7,8*	7,9
	-3,0 m																			3,4	5,9	5,2	6,9*	7,3
-4,5 m																			2,3	4,0	3,7	6,0*	6,4	
 5,5 m 2-piece boom 3,2 m arm for grab Front dozer blade Rear outriggers	9,0 m																		7,0*	7,0*	7,0*	7,0*	3,3	
	7,5 m																			4,1	5,2*	5,2*	5,2*	5,6
	6,0 m																			2,9	4,7*	4,4	4,7*	6,9
	4,5 m																			9,7*	9,7*	9,7*	9,7*	7,6
	3,0 m																			5,6	7,1*	7,1*	7,1*	8,0
	1,5 m																			5,0	9,1	7,9	9,1*	8,1
	0,0 m																			4,5	8,5	7,3	10,9*	7,9
	-1,5 m																			3,1	5,6	4,9	7,8*	7,9
	-3,0 m																			3,4	5,9	5,2	6,9*	7,3
-4,5 m																			2,3	4,0	3,7	6,0*	6,4	
 5,5 m 2-piece boom 2,45 m dipper arm Front and rear outriggers	9,0 m																		7,0*	7,0*	7,0*	7,0*	3,3	
	7,5 m																			4,1	5,2*	5,2*	5,2*	5,6
	6,0 m																			2,9	4,7*	4,4	4,7*	6,9
	4,5 m																			9,7*	9,7*	9,7*	9,7*	7,6
	3,0 m																			5,6	7,1*	7,1*	7,1*	8,0
	1,5 m																			5,0	9,1	7,9	9,1*	8,1
	0,0 m																			4,5	8,5	7,3	10,9*	7,9
	-1,5 m																			3,1	5,6	4,9	7,8*	7,9
	-3,0 m																			3,4	5,9	5,2	6,9*	7,3
-4,5 m																			2,3	4,0	3,7	6,0*	6,4	
 5,5 m 2-piece boom 2,6 m dipper arm Front and rear outriggers	9,0 m																		7,0*	7,0*	7,0*	7,0*	3,3	
	7,5 m																			4,1	5,2*	5,2*	5,2*	5,6
	6,0 m																			2,9	4,7*	4,4	4,7*	6,9
	4,5 m																			9,7*	9,7*	9,7*	9,7*	7,6
	3,0 m																			5,6	7,1*	7,1*	7,1*	8,0
	1,5 m																			5,0	9,1	7,9	9,1*	8,1
	0,0 m																			4,5	8,5	7,3	10,9*	7,9
	-1,5 m																			3,1	5,6	4,9	7,8*	7,9
	-3,0 m																			3,4	5,9	5,2	6,9*	7,3
-4,5 m																			2,3	4,0	3,7	6,0*	6,4	

Notes: 1. Working pressure with Power Boost = 36 MPa.  
 2. The above values are in compliance with ISO standard 10 567. They do not exceed 87 % of hydraulic lifting capacity or 75 % of tipping load, with the machine on firm, level ground.  
 3. Load capacities marked with an asterisk (\*) are limited by machine's hydraulic lifting capacity rather than tipping load.



## STANDARD EQUIPMENT

### Engine

Turbocharged, 4 stroke Volvo diesel engine with water cooling, direct injection and charged air cooler that meets EU Step IIIA emission requirements

Intake air pre-heater  
Electric engine shut-off  
Fuel filter and water separator  
Fuel filler pump: 50 l/min with automatic shut-off  
Aluminium core radiator

### Electric/Electronic control system

Contronics-computerized monitoring and diagnostic system  
Master electrical disconnect switch  
Automatic idling system  
One-touch power boost  
Adjustable monitor  
Engine restart prevention circuit  
Safety stop/start function  
High capacity halogen lamps  
– Frame mounted 2  
– Cab mounted 2  
Alternator, 80 A  
Batteries, 2 x 12 V/140 Ah  
Start motor, 24 V/4,8 kW

### Undercarriage

2-speed power transmission plus creep speed  
Oscillating front axle  $\pm 9^\circ$   
2-circuit travel brakes  
Maintenance-free propeller shafts

### Superstructure

Counterweight, 4 500 kg  
Service walkway with anti-slip grating  
Centralised lubricating point for slew bearing

### Digging equipment

Attachment points for extra hydraulics  
Centralised lubrication point

### Cab and interior

Volvo Care Cab with fixed PC roof hatch  
Heater  
Hydraulic dampening cab mounts  
Adjustable operator seat and joystick control console  
Adjustable steering wheel  
Hydraulic safety lock lever  
Control joystick, with 4 switches each

Cab, all-weather sound suppressed, includes:

- Cup holder
  - Door locks
  - Safety glass, light tinted
  - Floor mat
  - Horn
  - Large storage area
  - Pull-up type front window
  - Removable lower windshield
  - Seat belt, 2 inch retractable
  - Windshield wiper with washer and intermittent feature
- Sun shield front, roof and rear  
Anti-vandalism kit assembly preparation  
Master ignition key

### Hydraulic system

Load sensing hydraulic system  
Cylinder cushioning  
Cylinder contamination seals  
Return filter of full flow type 2 000 h exchange interval  
Pressure relief system (servo accumulator)  
Thermostatically controlled cooling fan  
Hose rupture valve for boom  
Hydraulic oil, ISO VG 46

## OPTIONAL EQUIPMENT

### Engine

Diesel coolant heater with digital timer  
Block heater, 240 V  
Water separator with heater  
Dust net

### Electric

Travel alarm  
Rotating beacon  
Extra work lights:  
– Service walkway 1 and counterweight 1  
– Boom-mounted 2  
– Cab front 2  
Electric center passage  
Rear view camera  
Care Track via GSM  
Care Track via satellite  
Anti-theft system

### Hydraulic system

Hose rupture valve for dipper arm  
Boom float function  
Hydraulic oil, ISO VG 32  
Hydraulic oil, ISO VG 68  
Hydraulic oil, biodegradable 32  
Hydraulic oil, biodegradable 46  
Hydraulic equipment for:  
– Hammer & shears  
– Slope bucket/rotator  
– Grab/clam shell  
– Quick fit

### Cab and interior

Volvo Care Cab with openable PC roof hatch  
Heater and air-conditioner, automatic  
Proportional control joystick  
Falling object guard (FOG)  
Cab mounted falling object protective structures (FOPS)  
Rain shield, front  
Safety net for front window  
Lower wiper  
Anti-vandalism kit  
Ashtray  
Lighter  
Radio with cassette player  
AM/FM stereo with CD player and MP3 input; includes flexible antenna  
Operator seat:  
– Fabric seat, with heater  
– Fabric seat, with heater and air suspension

### Undercarriage

Twin tires 10.00 – 20 / 11.00 – 20  
Single tires 18R – 19.5 / 600 / 40-22.5  
Sparewheel  
Stone protection rings  
Front dozer blade and rear outriggers  
Rear dozer blade  
4 outriggers  
Grab holder  
Mudguards, front/rear  
Tool box, left hand side / right hand side  
Cruise control  
Travel speed 20 km/h, 25 km/h, 30 km/h  
Wide axle 2,75 m

### Superstructure

Counterweight, 3 900 kg

### Digging equipment

Booms  
5,6 m monoblock  
5,5 m 2-piece boom

Dipper arms  
2,45 m, 2,6 m, 2,9 m  
3,2 m grab arm

### Hydraulic quick fit

S1 system  
Universal system

### Attachments

Buckets, direct fit and quick fit:  
– General Purpose bucket (GP)  
– Heavy Duty bucket  
– Slope bucket  
– Hammer bracket, S1, direct fit (universal system)  
– Grab holder

### Service

Tool kit

Standard and optional equipment may vary by market. Please consult your local Volvo dealer for details.



## Notes

## Notes





Volvo Construction Equipment is different. Our machines are designed, built and supported in a different way. That difference comes from an engineering heritage of over 175 years. A heritage of thinking first about the people who actually use the machines. About how to help them be safer, more comfortable, more productive. About the environment we all share. The result of that thinking is a growing range of machines and a global support network dedicated to helping you do more. People around the world are proud to use Volvo. And we're proud of what makes Volvo different – **More care. Built in.**



*Not all products are available in all markets. Under our policy of continuous improvement, we reserve the right to change specifications and design without prior notice. The illustrations do not necessarily show the standard version of the machine.*

# **VOLVO**

**Volvo Construction Equipment**  
**[www.volvo.com](http://www.volvo.com)**

Ref. No. 21 A 100 4437  
Printed in Sweden 2008.04-3,0  
Volvo, Konz

English  
EXC