

VOLVO EXCAVATOR

EW170



- Engine power, gross:
119 kW (160 hp)
- Operating weight:
16.0 ~ 18.1 t
- Buckets (SAE):
760 ~ 940 l
- Low-emission, turbocharged and aftercooled Cummins diesel engine with direct injection
- Integrated mode selection system and electronically controlled system (ACS)
- 2 variable displacement axial piston pumps. Independent and simultaneous movement of the digging equipment is controlled by the "Automatic sensing work mode".
- Cab
 - Computerized control and warning system
 - Ergonomic environment
 - Low sound level
 - Filtered air
 - Hydraulic dampening mounts
- The hydraulic dual brake system, with the negative actuation of the parking brake, ensures safety
- 2-piece boom available as optional equipment
- Prepared for a number of optional items

VOLVO



ENGINE

The engine is a low-emission, turbocharged, 4-stroke diesel engine with water cooling, direct injection and aftercooler, especially developed for excavator use.

The machine can work at any job site, contributing to good fuel economy, low sound level, less wear and a longer life.

Air filter: 3-stage, includes pre-cleaner

Automatic idling system: Reduces the engine speed to an idling speed when levers are not activated.

Maker	CUMMINS
Model	B5.9-C
Power output at	32 r/s (1900 rpm)
Net (ISO 9249/DIN 6271)	107 kW (145 ps / 143 hp)
Gross (SAE J1349)	119 kW (162 ps / 160 hp)
Max. torque	618 N·m (63 kg·m) at 1500 rpm
No. of cylinders	6
Displacement	5.9 l
Bore	102 mm
Stroke	120 mm



ELECTRICAL SYSTEM

Well-protected electrical system with high capacity. Double lock harness plugs are waterproof to ensure secure connections and prevent corrosion.

The relays and solenoid valves are shielded to prevent accidental damage or terminal contact.

The master switch, for disconnecting the battery, is standard.

ACS system, providing integrated mode selection functions and self-diagnostic mode, is standard.

Voltage	24 V
Batteries	2 X 12 V
Battery capacity	150 Ah
Alternator	24 V / 50 A



SERVICE REFILL CAPACITIES

Fuel tank	295 l
Hydraulic system, total	340 l
Hydraulic tank	200 l
Engine oil	24 l
Engine coolant	26.5 l
Swing reduction unit	6.0 l
Transmission	3.8 l
Axle (front)	13.7 l
Axle (rear)	16.2 l



SWING SYSTEM

The superstructure is swung by the means of an axial piston motor and a planetary reduction unit. Automatic swing holding brake and anti-rebound valve are standard.

Max. swing speed 12.3 rpm



UNDERCARRIAGE

Drive train: One variable piston motor on the mid-mounted two-stage gearbox provides power to front and rear axles, both equipped with hub planetary reductions.

Lower frame: All-welded torsion box frame.

Tires: Single or double tires available.

Axle: Full floating with planetary gears

Steering: Hydraulic actuated, open center, non reaction type

Double tires, standard	10.00-20PR14
Max tractive effort	104.5 kN (10.7 ton)
Travel speed, 1st	8.6 km/h
.....	5.6 km/h (StVZO)
Travel speed, 2nd	32 km/h
.....	20 km/h (StVZO)
Min. turning radius, center of outer wheel	7.05 m
Gradeability	33° (63 %)
Oscillating angle, front axle	± 8°



BRAKES

Brake system corresponds ISO 3450

Service brakes consist of a dual circuit hydraulic system with multi wet discs

Parking brake of multi disc type, with negative actuation, is activated in the transmission by hydraulic control.

Auxiliary brake: Either the front brake or rear brake system can be used in the event of a failure in either of the service brake systems.

Working brake: The service brake is activated as the working brake by locking the latch type foot pedal.



HYDRAULIC SYSTEM

The hydraulic system, named "Automatic Sensing Work Mode", is designed for high productivity, high digging capacity, high maneuvering precision and good fuel economy.

The summation system, boom priority, arm priority, swing priority, and regeneration system of the boom and arm flows are provided for the best operation.

The following important functions are included in the system;

Summation system: Providing full use of the pump oil flow.

Boom priority: Providing priority to the boom operation for fast raising during loading or deep excavation.

Arm priority: Providing priority to the arm operation for faster cycle times during leveling and for increased bucket filling factors while digging.

Swing priority: Providing priority to the swing operation for faster swing during simultaneous operations.

Regeneration system: Enhancing the cylinder life cycle, preventing cavitation and providing priority to other movements during simultaneous operations.

Power boost: All digging and lifting forces are increased.

Holding valves: Boom and arm holding valves are standard.

Pumps

Main pump:

Type 2 X variable displacement axial piston pumps
Maximum flow 2 X 200 l/min

Pilot pump:

Type Gear pump
Maximum flow 18 l/min

Steering pump Gear pump

Brake pump Gear pump

Hydraulic motors

Travel Variable displacement axial piston motor
Swing Fixed displacement piston motor with mechanical brake

Relief valve setting

Attachment 31.4/34.3 MPa (320/350 kg/cm²)
Travel circuit 31.4 MPa (320 kg/cm²)
Steering circuit 14.7 MPa (150 kg/cm²)
Swing circuit 26.5 MPa (270 kg/cm²)
Pilot circuit 3.9 MPa (40 kg/cm²)

Hydraulic cylinders

Monobloc boom 2
bore X stroke Ø115 mm X 1165 mm
1st boom of 2-piece boom 2
bore X stroke Ø120 mm X 920 mm
2nd boom of 2-piece boom 1
bore X stroke Ø160 mm X 810 mm
Arm 1
bore X stroke Ø120 mm X 1495 mm
Bucket 1
bore X stroke Ø115 mm X 990 mm
Dozer blade, front or rear 2
bore X stroke Ø120 mm X 245 mm
Outriggers, front or rear 2
bore X stroke Ø130 mm X 380 mm



WEIGHT AND AXLE LOADS

Machine with 5.2 m monobloc boom, 2.6 m arm, 780 l bucket and 2900 kg counterweight.

Machine weight

incl. outriggers and dozer blade 17690 kg

Machine with 4.97 m 2-piece boom, 2.3 m arm, 780 l bucket and 2900 kg counterweight.

Machine weight

incl. outriggers and dozer blade 18320 kg



CAB

Easily accessible cab with a wide door and lined with sound-absorbing material.

The cab, which is supported by hydraulic dampening mounts to reduce shock and vibration, has all-around visibility.

The front windshield can slide up into the ceiling and the lower front glass can be removed.

Integrated air-conditioning and heating system:

The pressurized and filtered cab air is supplied by a 4-speed fan. The air is distributed via 8 vents.

Ergonomic operator's seat: The adjustable seat and control consoles move independently to accommodate the operator well. The seat has eight different adjustments and a seat belt to meet any operator's requirement.

Sound level (preliminary): According to the Directive 86/662/EEC.

Exterior noise (ISO 6395)

mean value of L_{WA} (sound power level) 101 dB(A)

Operator's position (ISO 6396)







with the door closed

mean value of L_{PA} (sound pressure level) 77 dB(A)

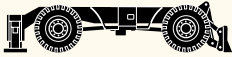





BUCKET & ARM COMBINATION

- Note: 1. Bucket size based on SAE-J296, heaped material with a 1:1 angle of repose
 2. Front designated as end with steer axle.
 3. Front dozer blade can not be used in combination with 2-piece boom assy.
 4. "Max. permitted sizes" are for guidance only, not available from factory.

● Max. permitted sizes for direct fit buckets with 2900 kg counterweight







Support condition		Description	unit	5.2 m monobloc boom		4.97 m 2-piece boom	
Front	Rear			2.6 m Arm	3.1 m Arm	2.3 m Arm	2.6 m Arm
		GP bucket 1.5 t/m ³	l	1450	1325	1625	1525
		GP bucket 1.8 t/m ³	l	1250	1150	1425	1325
		GP bucket 2.0 t/m ³	l	1150	1075	1300	1225
		GP bucket 1.5 t/m ³	l	1650	1500	1825	1725
		GP bucket 1.8 t/m ³	l	1425	1325	1600	1525
		GP bucket 2.0 t/m ³	l	1325	1200	1475	1400
		GP bucket 1.5 t/m ³	l	1075	1000	1225	1150
		GP bucket 1.8 t/m ³	l	950	875	1075	1000
		GP bucket 2.0 t/m ³	l	875	800	1000	925
		GP bucket 1.5 t/m ³	l	1450	1325	–	–
		GP bucket 1.8 t/m ³	l	1250	1150	–	–
		GP bucket 2.0 t/m ³	l	1175	1075	–	–
		GP bucket 1.5 t/m ³	l	1075	975	–	–
		GP bucket 1.8 t/m ³	l	925	850	–	–
		GP bucket 2.0 t/m ³	l	850	775	–	–
		GP bucket 1.5 t/m ³	l	1250	1125	1400	1325
		GP bucket 1.8 t/m ³	l	1075	1000	1225	1150
		GP bucket 2.0 t/m ³	l	1000	925	1125	1075
		GP bucket 1.5 t/m ³	l	875	800	1000	925
		GP bucket 1.8 t/m ³	l	750	700	875	825
		GP bucket 2.0 t/m ³	l	700	625	800	750

● Max. permitted sizes for quick fit buckets with 2900 kg counterweight







Support condition		Description	unit	5.2 m monobloc boom		4.97 m 2-piece boom	
Front	Rear			2.6 m Arm	3.1 m Arm	2.3 m Arm	2.6 m Arm
		GP bucket 1.5 t/m ³	l	1375	1250	1550	1475
		GP bucket 1.8 t/m ³	l	1200	1100	1350	1275
		GP bucket 2.0 t/m ³	l	1125	1025	1250	1175
		GP bucket 1.5 t/m ³	l	1575	1450	1775	1675
		GP bucket 1.8 t/m ³	l	1375	1250	1550	1450
		GP bucket 2.0 t/m ³	l	1275	1175	1425	1350
		GP bucket 1.5 t/m ³	l	1025	925	1175	1100
		GP bucket 1.8 t/m ³	l	900	825	1025	950
		GP bucket 2.0 t/m ³	l	825	750	950	875
		GP bucket 1.5 t/m ³	l	1375	1275	–	–
		GP bucket 1.8 t/m ³	l	1200	1100	–	–
		GP bucket 2.0 t/m ³	l	1125	1025	–	–
		GP bucket 1.5 t/m ³	l	1000	900	–	–
		GP bucket 1.8 t/m ³	l	875	800	–	–
		GP bucket 2.0 t/m ³	l	800	725	–	–
		GP bucket 1.5 t/m ³	l	1175	1075	1350	1250
		GP bucket 1.8 t/m ³	l	1025	950	1175	1100
		GP bucket 2.0 t/m ³	l	950	875	1075	1025
		GP bucket 1.5 t/m ³	l	800	725	925	875
		GP bucket 1.8 t/m ³	l	700	625	800	750
		GP bucket 2.0 t/m ³	l	650	575	750	700

BUCKET & ARM COMBINATION

●Volvo K bucket (straight side) and 5.2 m monobloc boom

Bucket		Narrow bucket	Standard bucket	Reinforced bucket	Wide bucket
Bucket capacity (SAE / CECE)		580 / 500 l	760 / 650 l	760 / 650 l	940 / 800 l
Bucket width (with/without side cutter)		905 / 795 mm	1000 / 990 mm	1100 / 990 mm	1300 / 1190 mm
Weight (with side cutter)		482 kg	545 kg	610 kg	605 kg
No. of teeth		4	5	5	5
Arm: 2.6 m (3.1 m)	 Front Rear	⊙(⊙)	⊙(⊙)	⊙(⊙)	⊙(⊙)
	 Front Rear	⊙(⊙)	⊙(⊙)	⊙(⊙)	⊙(⊙)
	 Front Rear	⊙(⊙)	⊙(○)	⊙(○)	□(□)
	 Front Rear	⊙(⊙)	⊙(⊙)	⊙(⊙)	⊙(⊙)
	 Front Rear	⊙(⊙)	⊙(○)	○(○)	□(□)
	 Front Rear	⊙(⊙)	⊙(⊙)	⊙(⊙)	○(□)
	 Front Rear	⊙(○)	□(△)	□(△)	△(-)

●Volvo GP bucket (curved side) and 5.2 m monobloc boom

Bucket		Direct fit - GP bucket			Quick fit - GP bucket	
Bucket capacity (SAE / CECE)		550 / 500 l	780 / 710 l	920 / 830 l	630 / 570 l	780 / 710 l
Cutting width		770 mm	1000 mm	1140 mm	850 mm	1000 mm
Weight		465 kg	567 kg	618 kg	480 kg	545 kg
No. of teeth		4	5	5	4	5
Arm: 2.6 m (3.1 m)	 Front Rear	⊙(⊙)	⊙(⊙)	⊙(○)	⊙(⊙)	⊙(⊙)
	 Front Rear	⊙(⊙)	⊙(⊙)	⊙(⊙)	⊙(⊙)	⊙(⊙)
	 Front Rear	⊙(⊙)	○(□)	□(△)	⊙(⊙)	□(□)
	 Front Rear	⊙(⊙)	⊙(⊙)	⊙(⊙)	⊙(⊙)	⊙(⊙)
	 Front Rear	⊙(⊙)	○(□)	□(△)	⊙(○)	□(□)
	 Front Rear	⊙(⊙)	⊙(○)	○(□)	⊙(⊙)	⊙(○)
	 Front Rear	⊙(○)	△(△)	△(-)	□(□)	△(△)

⊙ : Applicable for material density up to 2.0 t/m³

○ : Applicable for material density up to 1.8 t/m³

□ : Applicable for material density up to 1.5 t/m³

△ : Applicable for material density up to 1.2 t/m³

- : Not usable

DIMENSIONS

• Transport

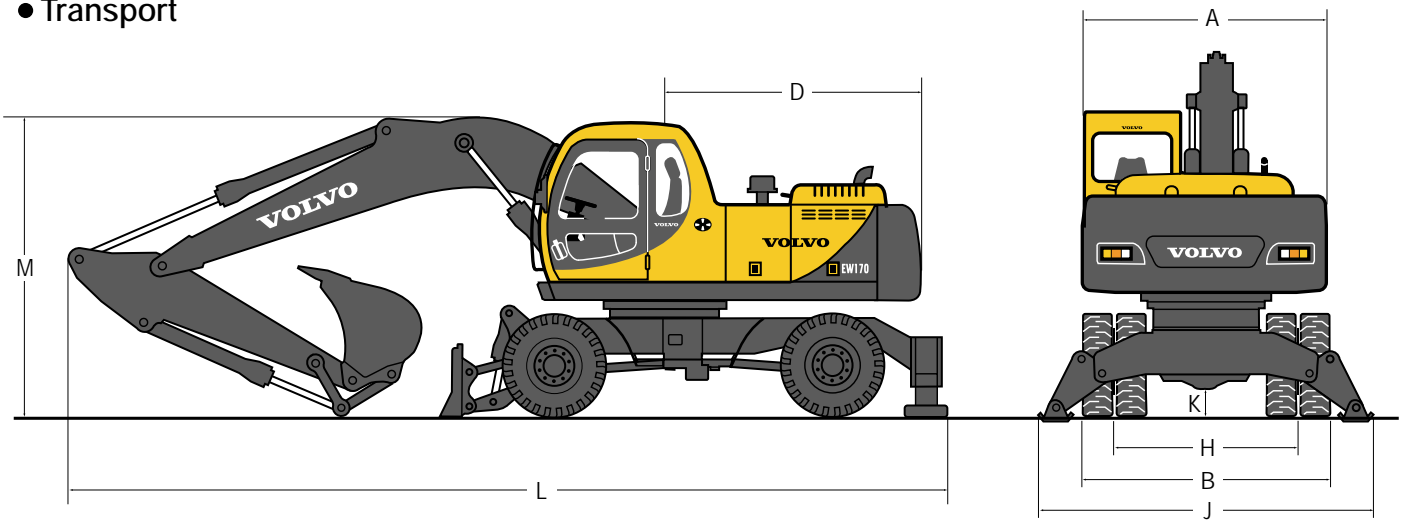

• Travel (Monobloc boom)

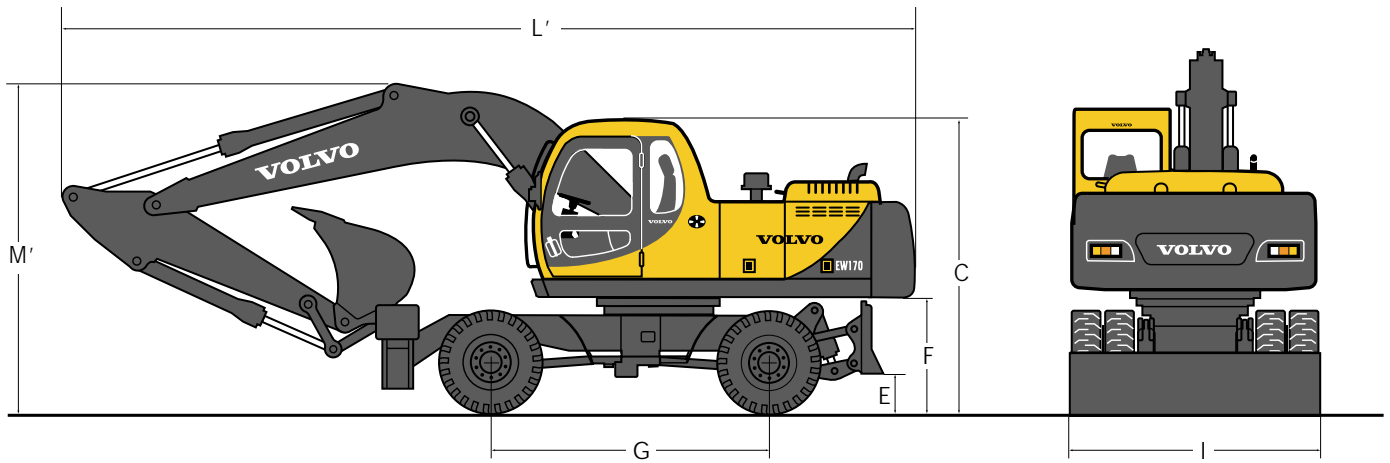

• Travel (2-piece boom)

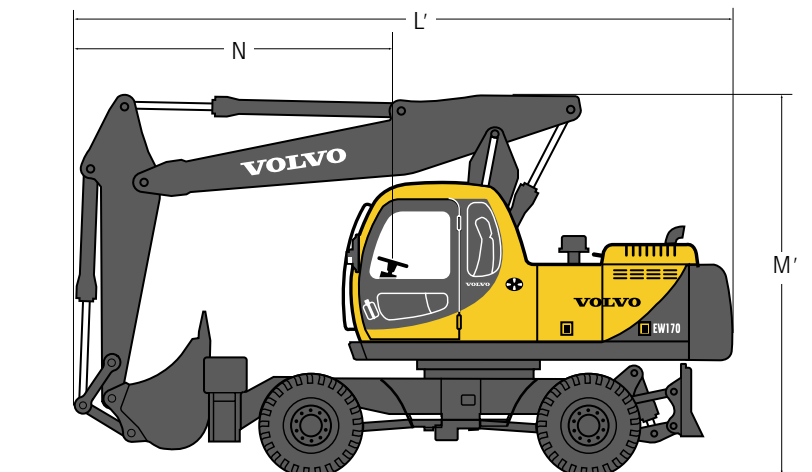

DIMENSIONS

Description	unit	5.2 m monobloc boom		4.97 m 2-piece boom	
		2.6 m Arm	3.1 m Arm	2.3 m Arm	2.6 m Arm
A. Overall width of upper structure	mm	2460	2460	2460	2460
B. Overall width	mm	2495	2495	2495	2495
C. Overall height of cab	mm	3090	3090	3090	3090
D. Tail swing radius	mm	2600	2600	2600	2600
E. Dozer blade clearance	mm	400	400	400	400
F. Counterweight clearance	mm	1250	1250	1250	1250
G. Wheel base	mm	2800	2800	2800	2800
H. Tread	mm	1874	1874	1874	1874
I. Dozer blade width, front or rear	mm	2495	2495	2495	2495
J. Outrigger width, down front or rear	mm	3390	3390	3390	3390
K. Min. ground clearance	mm	320	320	320	320
L. Overall length	mm	9160	9205	8990	8980
L'. Overall length	mm	8950	8830	6900	6890
M. Overall height of boom	mm	3100	3460	3340	3380
M'. Overall height of boom	mm	3750	3950	3995	4100
N. Front overhang	mm	-	-	3455	3470

● Boom

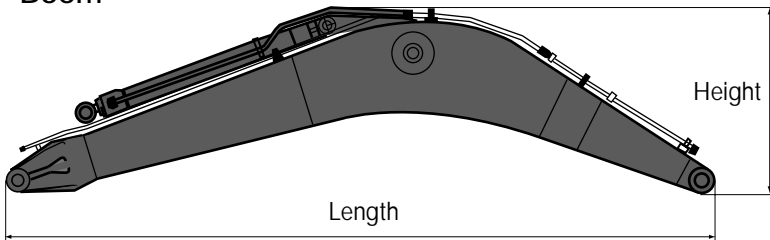

Description	5.2 m
Length	5400 mm
Height	1625 mm
Width	564 mm
Weight *	1320 kg

* Includes cylinder, piping and pin

● 2-piece boom

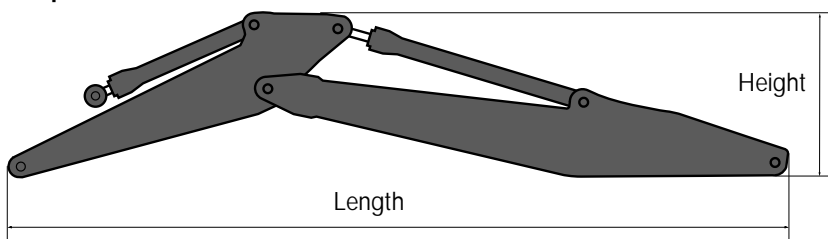

Description	4.97 m
Length	5010 mm
Height	1350 mm
Width	564 mm
Weight *	1630 kg

* Includes cylinders, piping and pins

● Arm

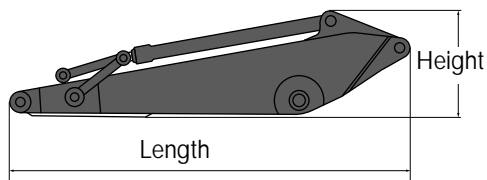

Description	2.3 m	2.6 m	3.1 m
Length	3260 mm	3560 mm	4070 mm
Height	870 mm	870 mm	870 mm
Width	304 mm	304 mm	304 mm
Weight *	650 kg	685 kg	760 kg

* Includes cylinder, linkage and pins

WORKING RANGES

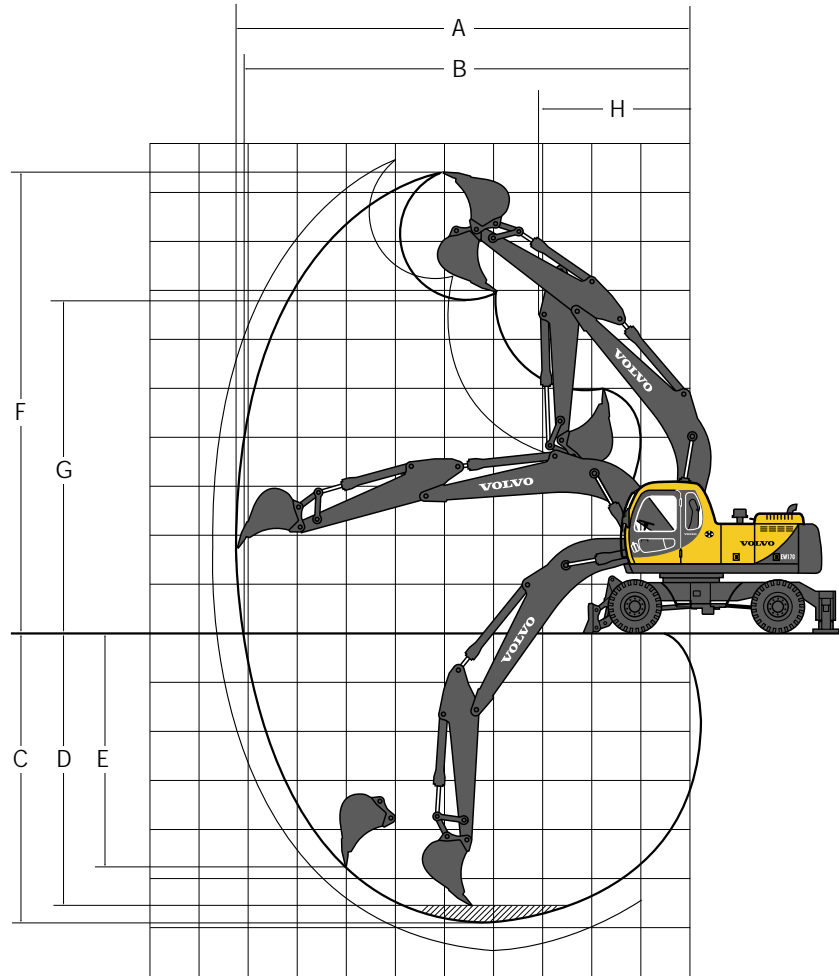

● 5.2 m monobloc boom with direct fit bucket

Description	unit	2.6 m Arm	3.1 m Arm
A. Max. digging reach	mm	9170	9600
B. Max. digging reach on ground	mm	8960	9400
C. Max. digging depth	mm	5900	6400
D. Max. digging depth (8' level)	mm	5680	6200
E. Max. vertical wall digging depth	mm	4790	5120
F. Max. cutting height	mm	9420	9590
G. Max. dumping height	mm	6680	6870
H. Min. front swing radius	mm	3080	3080

Digging forces with direct fit bucket:		unit	2.6 m Arm	3.1 m Arm
Bucket tip radius		mm	1420	1420
Breakout force-bucket (Normal / Power boost)	SAE	kN (ton)	103.5 / 113.2 (10.6 / 11.5)	103.5 / 113.2 (10.6 / 11.5)
Breakout force-bucket (Normal / Power boost)	ISO	kN (ton)	114.6 / 125.4 (11.7 / 12.8)	114.6 / 125.4 (11.7 / 12.8)
Tearout force-arm (Normal / Power boost)	SAE	kN (ton)	78.6 / 85.9 (8.0 / 8.8)	69.7 / 76.2 (7.1 / 7.8)
Tearout force-arm (Normal / Power boost)	ISO	kN (ton)	80.3 / 87.9 (8.2 / 9.0)	71.2 / 77.9 (7.3 / 7.9)
Rotation angle, bucket		°	177°	177°

WORKING RANGES

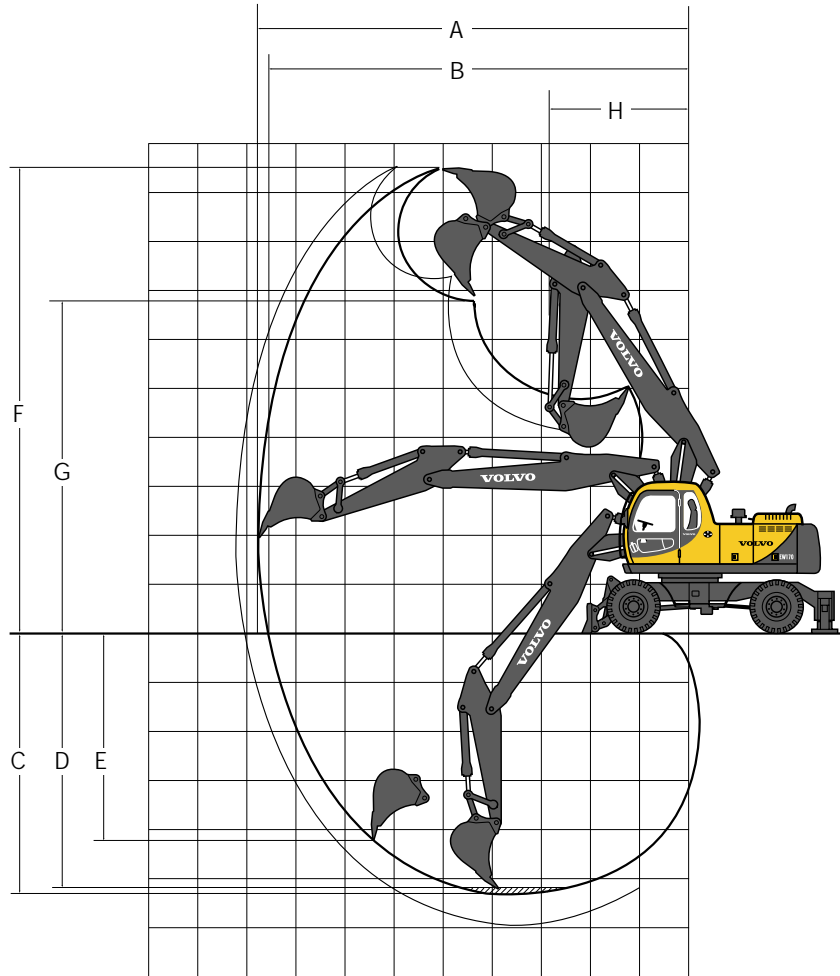

● 4.97 m 2-piece boom with direct fit bucket



















Description	unit	2.3 m Arm	2.6 m Arm
A. Max. digging reach	mm	8760	9170
B. Max. digging reach on ground	mm	8540	8960
C. Max. digging depth	mm	5260	5900
D. Max. digging depth (8' level)	mm	5160	5680
E. Max. vertical wall digging depth	mm	4200	4790
F. Max. cutting height	mm	9610	9420
G. Max. dumping height	mm	6800	6680
H. Min. front swing radius	mm	2860	3080

Digging forces with direct fit bucket:		unit	2.3 m Arm	2.6 m Arm
Bucket tip radius		mm	1420	1420
Breakout force-bucket (Normal / Power boost)	SAE	kN (ton)	103.5 / 113.2 (10.6 / 11.5)	103.5 / 113.2 (10.6 / 11.5)
Breakout force-bucket (Normal / Power boost)	ISO	kN (ton)	114.6 / 125.4 (11.7 / 12.8)	114.6 / 125.4 (11.7 / 12.8)
Tearout force-arm (Normal / Power boost)	SAE	kN (ton)	85.1 / 93.0 (8.7 / 9.5)	78.6 / 85.9 (8.0 / 8.8)
Tearout force-arm (Normal / Power boost)	ISO	kN (ton)	87.0 / 95.2 (8.9 / 9.7)	80.3 / 87.9 (8.2 / 9.0)
Rotation angle, bucket		°	177°	177°

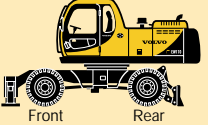
LIFTING CAPACITY (At the arm end without bucket)

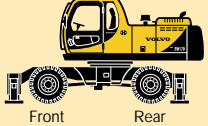
Note: For lift capacity including bucket, simply subtract actual weight of the direct fit bucket or the bucket with quick fit from the following values.

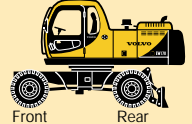
EW170 (5.2 m monobloc boom + 2.6 m arm)



















 Across undercarriage  Along undercarriage	Lifting hook related to ground level	3 m		4.5 m		6 m		7.5 m		Max.reach		Max. mm
		 kg	 kg	 kg	 kg	 kg	 kg	 kg	 kg	 kg	 kg	
 Front  Rear	6 m					*3850	*3850			*3560	*3560	6544
	4.5 m			*4460	*4460	*4160	*4160			3250	*3480	7290
	3 m			*6020	*6020	4280	*4850	3050	*4440	2940	*3560	7669
	1.5 m			6230	*7590	4110	*5620	2980	*4780	2850	*3830	7735
	0 m	*5790	*5790	6030	*8560	3990	*6220			2940	*4360	7497
	-1.5 m	*10380	*10380	5980	*8820	3960	*6450			3270	*5370	6924
	-3 m	12000	*12260	6050	*8310					4110	*6000	5914
 Front  Rear	6 m					*3850	*3850			*3560	*3560	6544
	4.5 m			*4460	*4460	*4160	*4160			*3480	*3480	7290
	3 m			*6020	*6020	*4850	*4850	3460	*4440	3340	*3560	7669
	1.5 m			7210	*7590	4690	*5620	3390	*4780	3240	*3830	7735
	0 m	*5790	*5790	7000	*8560	4570	*6220			3340	*4360	7497
	-1.5 m	*10380	*10380	6950	*8820	4530	*6450			3720	*5370	6924
	-3 m	*12260	*12260	7020	*8310					4700	*6000	5914
 Front  Rear	6 m					3300	*3850			2840	*3560	6544
	4.5 m			*4460	*4460	3210	*4160			2330	*3480	7290
	3 m			4640	*6020	3060	*4850	2170	*4440	2090	*3560	7669
	1.5 m			4310	*7590	2900	*5620	2100	*4780	2010	*3830	7735
	0 m	*5790	*5790	4130	*8560	2790	*6220			2060	*4360	7497
	-1.5 m	7560	*10380	4080	*8820	2750	*6450			2290	5370	6924
	-3 m	7710	*12260	4150	*8310					2880	*6000	5914

- Notes :
1. Machine in "Fine Mode-F" (Power Boost), for lift capacities.
 2. The above loads are in compliance with SAE and ISO Hydraulic Excavator Lift Capacity Standards.
 3. Rated loads do not exceed 87% of hydraulic lifting capacity or 75% of tipping load.
 4. Rated loads marked with an asterisk (*) are limited by hydraulic capacity rather than tipping load.

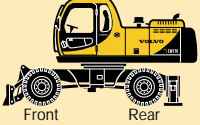
LIFTING CAPACITY (At the arm end without bucket)

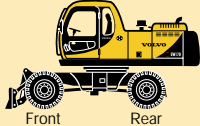
Note: For lift capacity including bucket, simply subtract actual weight of the direct fit bucket or the bucket with quick fit from the following values.

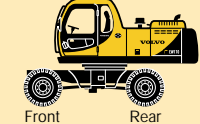
EW170 (5.2 m monobloc boom + 2.6 m arm)

 Across undercarriage  Along undercarriage	Lifting hook related to ground level	3 m		4.5 m		6 m		7.5 m		Max.reach		Max. mm
		 kg	 kg	 kg	 kg	 kg	 kg	 kg	 kg	 kg	 kg	
 Front  Rear	6 m					*3850	*3850			*3560	*3560	6544
	4.5 m			*4460	*4460	*4160	*4160			*3480	*3480	7290
	3 m			*6020	*6020	*4850	*4850	3460	*4440	3340	*3560	7669
	1.5 m			7210	*7590	4690	*5620	3390	*4780	3240	*3830	7735
	0 m	*5790	*5790	7000	*8560	4570	*6220			3340	*4360	7497
	-1.5 m	*10380	*10380	6950	*8820	4530	*6450			3720	*5370	6924
	-3 m	*12260	*12260	7020	*8310					4700	*6000	5914
 Front  Rear	6 m					2900	*3850			2490	*3560	6544
	4.5 m			4380	*4460	2820	*4160			2030	*3480	7290
	3 m			4030	*6020	2670	*4850	1890	3560	1820	3430	7669
	1.5 m			3710	*7590	2510	4880	1820	3480	1740	3320	7735
	0 m	*5790	*5790	3530	7440	2410	4750			1780	3440	7497
	-1.5 m	6300	*10380	3490	7380	2370	4710			1980	3840	6924
	-3 m	6440	*12260	3550	7460					2480	4890	5914
 Front  Rear	6 m					2880	*3850			2470	*3560	6544
	4.5 m			4350	*4460	2800	*4160			2020	*3480	7290
	3 m			4000	*6020	2650	*4850	1870	3770	1800	*3560	7669
	1.5 m			3680	*7590	2490	5170	1810	3700	1720	3530	7735
	0 m	*5790	*5790	3510	7890	2390	5040			1770	3650	7497
	-1.5 m	6260	*10380	3460	7830	2350	5000			1960	4080	6924
	-3 m	6400	*12260	3520	7910					2470	5190	5914

- Notes :
1. Machine in "Fine Mode-F" (Power Boost), for lift capacities.
 2. The above loads are in compliance with SAE and ISO Hydraulic Excavator Lift Capacity Standards.
 3. Rated loads do not exceed 87% of hydraulic lifting capacity or 75% of tipping load.
 4. Rated loads marked with an asterisk (*) are limited by hydraulic capacity rather than tipping load.

LIFTING CAPACITY (At the arm end without bucket)

Note: For lift capacity including bucket, simply subtract actual weight of the direct fit bucket or the bucket with quick fit from the following values.

EW170 (5.2 m monobloc boom + 3.1 m arm)

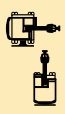
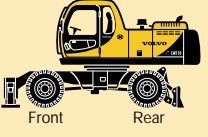
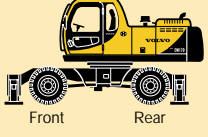
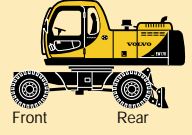













 Across undercarriage Along undercarriage	Lifting hook related to ground level	3 m		4.5 m		6 m		7.5 m		Max.reach		Max. mm
		kg	kg	kg	kg	kg	kg	kg	kg	kg	kg	
 Front Rear	6 m					*2510	*2510			*2400	*2400	7049
	4.5 m					*2880	*2880	2730	*2920	*2370	*2370	7746
	3 m	*6910	*6910	*4410	*4410	*3550	*3550	2670	*3200	2310	*2470	8102
	1.5 m	*5130	*5130	*5920	*5920	3770	*4310	2590	*3590	2230	*2700	8165
	0 m	*5980	*5980	5690	*6980	3620	*4940	2530	*3920	2300	*3130	7940
	-1.5 m	*9160	*9160	5590	*7430	3560	*5280			2560	*3910	7403
	-3 m	*11120	*11120	5630	*7240	3580	*5110			3200	*4570	6471
 Front Rear	6 m					*2510	*2510			*2400	*2400	7049
	4.5 m					*2880	*2880	*2920	*2920	*2370	*2370	7746
	3 m	*6910	*6910	*4410	*4410	*3550	*3550	3090	*3200	*2470	*2470	8102
	1.5 m	*5130	*5130	*5920	*5920	*4310	*4310	3000	*3590	2590	*2700	8165
	0 m	*5980	*5980	6670	*6980	4200	*4940	2930	*3920	2670	*3130	7940
	-1.5 m	*9160	*9160	6560	*7430	4130	*5280			2980	*3910	7403
	-3 m	*11120	*11120	6600	*7240	4160	*5110			3710	*4570	6471
 Front Rear	6 m					*2510	*2510			2120	*2400	7049
	4.5 m					2880	*2880	1850	*2920	1710	*2370	7746
	3 m	*6910	*6910	4400	*4410	2720	*3550	1790	*3200	1510	*2470	8102
	1.5 m	*5130	*5130	4020	*5920	2550	*4310	1710	*3590	1440	*2700	8165
	0 m	*5980	*5980	3780	*6980	2410	*4940	1650	*3920	1490	*3130	7940
	-1.5 m	7100	*9160	3690	*7430	2350	*5280			1670	*3910	7403
	-3 m	7230	*11120	3720	*7240	2380	*5110			2120	*4570	6471

- Notes :
1. Machine in "Fine Mode-F" (Power Boost), for lift capacities.
 2. The above loads are in compliance with SAE and ISO Hydraulic Excavator Lift Capacity Standards.
 3. Rated loads do not exceed 87% of hydraulic lifting capacity or 75% of tipping load.
 4. Rated loads marked with an asterisk (*) are limited by hydraulic capacity rather than tipping load.

LIFTING CAPACITY (At the arm end without bucket)

Note: For lift capacity including bucket, simply subtract actual weight of the direct fit bucket or the bucket with quick fit from the following values.

EW170 (5.2 m monobloc boom + 3.1 m arm)

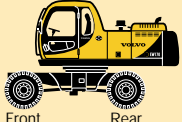











 Across undercarriage  Along undercarriage	Lifting hook related to ground level	3 m		4.5 m		6 m		7.5 m		Max.reach		Max. mm
		 kg	 kg	 kg	 kg	 kg	 kg	 kg	 kg	 kg	 kg	
 Front Rear	6 m					*3320	*3320			*2870	*2870	7049
	4.5 m					*3710	*3710	3540	*3580	*2820	*2820	7746
	3 m	*8090	*8090	*5370	*5370	*4440	*4440	3470	*4090	*2900	*2900	8102
	1.5 m	*5700	*5700	*7050	*7050	4700	*5290	3370	*4510	2970	*3110	8165
	0 m	*6520	*6520	6990	*8240	4550	*5990	3300	*4880	3050	*3510	7940
	-1.5 m	*9720	*9720	6890	*8740	4480	*6360			3340	*4250	7403
	-3 m	*12820	*12820	6920	*8520	4510	*6180			4070	*5580	6471
 Front Rear	6 m					2950	*3320			2210	*2870	7049
	4.5 m					2850	*3710	1960	*3580	1840	*2820	7746
	3 m	7400	*8090	4100	*5370	2690	*4440	1890	3570	1650	*2900	8102
	1.5 m	*5700	*5700	3740	*7050	2510	4890	1810	3470	1580	3050	8165
	0 m	6200	*6520	3510	7430	2380	4730	1740	3400	1600	3130	7940
	-1.5 m	6180	*9720	3430	7320	2320	4660			1760	3440	7403
	-3 m	6290	*12820	3460	7360	2350	4690			2130	4210	6471
 Front Rear	6 m					*2510	*2510			1790	*2400	7049
	4.5 m					2460	*2880	1550	*2920	1430	*2370	7746
	3 m	*6910	*6910	3750	*4410	2310	*3550	1490	*3200	1250	*2470	8102
	1.5 m	*5130	*5130	3380	*5920	2140	*4310	1420	3320	1180	*2700	8165
	0 m	5810	*5980	3150	*6980	2010	4680	1350	3250	1210	2950	7940
	-1.5 m	5800	*9160	3060	*7430	1950	4610			1370	3300	7403
	-3 m	5920	*11120	3090	*7240	1970	4640			1760	4120	6471

- Notes :
1. Machine in "Fine Mode-F" (Power Boost), for lift capacities.
 2. The above loads are in compliance with SAE and ISO Hydraulic Excavator Lift Capacity Standards.
 3. Rated loads do not exceed 87% of hydraulic lifting capacity or 75% of tipping load.
 4. Rated loads marked with an asterisk (*) are limited by hydraulic capacity rather than tipping load.

LIFTING CAPACITY (At the arm end without bucket)

Note: For lift capacity including bucket, simply subtract actual weight of the direct fit bucket or the bucket with quick fit from the following values.

EW170 (4.97 m 2-piece boom + 2.3 m arm)

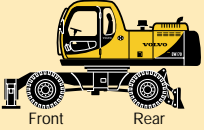
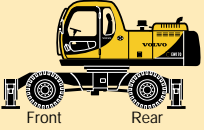
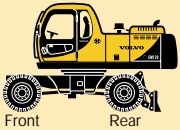
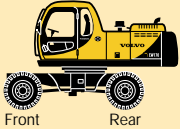











 Across undercarriage  Along undercarriage	Lifting hook related to ground level	3 m		4.5 m		6 m		7.5 m		Max.reach		Max. mm
		 kg	 kg	 kg	 kg	 kg	 kg	 kg	 kg	 kg	 kg	
 Front Rear	7.5 m			*4000	*4000					*4170	*4170	4636
	6 m			*3590	*3590	*4250	*4250			*3910	*3910	6051
	4.5 m	*5090	*5090	*4470	*4470	*4370	*4370			3680	*3720	6853
	3 m			*6130	*6130	4420	*5070			3300	*3740	7255
	1.5 m			6450	*7910	4260	*5960			3200	*3960	7325
	0 m	*6120	*6120	6260	*9200	4150	*6750			3310	*4440	7074
	-1.5 m	12220	*12230	6210	*9830	4120	*7220			3740	*5420	6462
 Front Rear	7.5 m			*4000	*4000					*4170	*4170	4636
	6 m			*3590	*3590	*4250	*4250			*3910	*3910	6051
	4.5 m	*5090	*5090	*4470	*4470	*4370	*4370			*3720	*3720	6853
	3 m			*6130	*6130	5010	*5070			3740	*3740	7255
	1.5 m			7450	*7910	4850	*5960			3630	*3960	7325
	0 m	*6120	*6120	7250	*9200	4740	*6750			3760	*4440	7074
	-1.5 m	*12230	*12230	7200	*9830	4710	*7220			4260	*5420	6462
 Front Rear	7.5 m			*4000	*4000					*4170	*4170	4636
	6 m			*3590	*3590	3340	*4250			3290	*3910	6051
	4.5 m	*5090	*5090	*4470	*4470	3310	*4370			2650	*3720	6853
	3 m			4810	*6130	3170	*5070			2370	*3740	7255
	1.5 m			4490	*7910	3030	*5960			2270	*3960	7325
	0 m	*6120	*6120	4310	*9200	2920	*6750			2340	*4440	7074
	-1.5 m	7850	*12230	4270	*9830	2900	6940			2640	*5420	6462
 Front Rear	7.5 m			*4000	*4000					*4170	*4170	4636
	6 m			*3590	*3590	2920	*4250			2870	*3910	6051
	4.5 m	*5090	*5090	*4470	*4470	2880	*4370			2310	*3720	6853
	3 m			4150	*6130	2750	*5070			2050	*3740	7255
	1.5 m			3840	*7910	2610	5350			1960	*3960	7325
	0 m	*6120	*6120	3670	8170	2510	5230			2020	4120	7074
	-1.5 m	6520	*12230	3630	8110	2480	5200			2270	4690	6462

- Notes :
- Machine in "Fine Mode-F" (Power Boost), for lift capacities.
 - The above loads are in compliance with SAE and ISO Hydraulic Excavator Lift Capacity Standards.
 - Rated loads do not exceed 87% of hydraulic lifting capacity or 75% of tipping load.
 - Rated loads marked with an asterisk (*) are limited by hydraulic capacity rather than tipping load.

LIFTING CAPACITY (At the arm end without bucket)

Note: For lift capacity including bucket, simply subtract actual weight of the direct fit bucket or the bucket with quick fit from the following values.

EW170 (4.97 m 2-piece boom + 2.6 m arm)

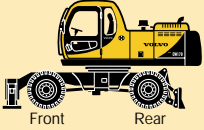
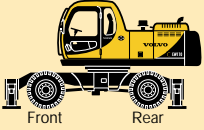
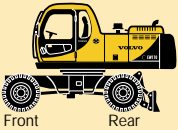
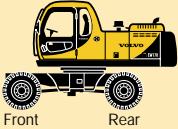
 Across undercarriage  Along undercarriage	Lifting hook related to ground level	3 m		4.5 m		6 m		7.5 m		Max.reach		
		 kg	 kg	 kg	 kg	 kg	 kg	 kg	 kg	 kg	 kg	Max. mm
 Front Rear	7.5 m			*3360	*3360					*3880	*3880	5084
	6 m			*3160	*3160	*3840	*3840			*3380	*3380	6398
	4.5 m			*4060	*4060	*4070	*4070			*3210	*3210	7160
	3 m			*5710	*5710	4430	*4800	3150	*3580	3120	*3230	7545
	1.5 m			6490	*7560	4270	*5730	3090	*4320	3020	*3410	7612
	0 m	*6470	*6470	6260	*8960	4140	*6580			3110	*3790	7371
	-1.5 m	*11370	*11370	6190	*9730	4100	*7140			3470	*4560	6786
 Front Rear	7.5 m			*3360	*3360					*3880	*3880	5084
	6 m			*3160	*3160	*3840	*3840			*3380	*3380	6398
	4.5 m			*4060	*4060	*4070	*4070			*3210	*3210	7160
	3 m			*5710	*5710	*4800	*4800	3570	*3580	*3230	*3230	7545
	1.5 m			7490	*7560	4860	*5730	3500	*4320	*3410	*3410	7612
	0 m	*6470	*6470	7260	*8960	4740	*6580			3540	*3790	7371
	-1.5 m	*11370	*11370	7180	*9730	4680	*7140			3960	*4560	6786
 Front Rear	7.5 m			*3360	*3360					*3880	*3880	5084
	6 m			*3160	*3160	3400	*3840			3030	*3380	6398
	4.5 m			*4060	*4060	3330	*4070			2480	*3210	7160
	3 m			4860	*5710	3190	*4800	2250	*3580	2230	*3230	7545
	1.5 m			4520	*7560	3030	*5730	2190	*4320	2140	*3410	7612
	0 m	*6470	*6470	4320	*8960	2920	*6580			2200	*3790	7371
	-1.5 m	7810	*11370	4250	*9730	2870	6910			2450	*4560	6786
 Front Rear	7.5 m			*3360	*3360					3840	*3880	5084
	6 m			*3160	*3160	2970	*3840			2640	*3380	6398
	4.5 m			*4060	*4060	2910	*4070			2160	*3210	7160
	3 m			4200	*5710	2770	*4800	1950	*3580	1930	*3230	7545
	1.5 m			3880	*7560	2620	5360	1890	3830	1850	*3410	7612
	0 m	*6470	*6470	3680	8180	2500	5230			1890	*3790	7371
	-1.5 m	6480	*11370	3610	8090	2460	5170			2100	4350	6786

- Notes :
- Machine in "Fine Mode-F" (Power Boost), for lift capacities.
 - The above loads are in compliance with SAE and ISO Hydraulic Excavator Lift Capacity Standards.
 - Rated loads do not exceed 87% of hydraulic lifting capacity or 75% of tipping load.
 - Rated loads marked with an asterisk (*) are limited by hydraulic capacity rather than tipping load.

STANDARD EQUIPMENT

Engine

Low-emission engine with air heater, complying with EPA (Environment Protection Association, USA) emission standards
2-stage air filter with indicator
Air pre-cleaner
Alternator, 50A
Electric engine shut-off
Fuel filter and water separator
Fuel filler pump: 35 lpm

Electronic control system

Advanced control system (ACS)
Integrated mode selection system
Self-diagnostic system
Machine status indication
Engine speed sensing power control
Automatic idling system

One-touch power boost
Automatic engine warm-up
Safety stop/start function
Adjustable monitor
Master disconnect switch
Engine restart prevention circuit
Powerful halogen lights:
- Frame-mounted 2
- Boom-mounted 2
Batteries, 2 X 12V/150Ah
Start motor, 24V/7.5kW
Air conditioner and heater
Rotating warning beacon

Hydraulic system

Automatic sensing work mode
- Summation system
- Boom priority
- Arm priority
- Swing priority
Boom and arm flow regeneration

Swing anti-rebound valve
Boom and arm holding valves
Multi-stage filtering system
Cylinder cushions
Cylinder contamination seals
Auxiliary hydraulic valve
Hydraulic oil, ISO VG 46

Superstructure

Access way with handrail
Tool storage box, locking
Punched metal anti-slip plates
Counterweight, 2900 kg

Cab and interior

Hydraulic dampening cab mounts
Tiltable and telescopic steering column
Adjustable operator seat and control console
Flexible antenna

Hydraulic safety lock lever
Cab, all-weather sound suppressed, includes:
- Ashtray
- Cigar lighter
- Door locks
- Floor mat
- Horn
- Large storage area
- Pull-up type front window
- Removable lower windshield
- Seat belt
- Safety glass
- Clear tinted roof hatch
- Windshield wiper with intermittent feature
- Stereo cassette radio (AM/FM)
Rain shield, front
Sun shield, front

ALTERNATIVE EQUIPMENT

Hydraulic system

Pilot-operated wrist control joysticks
- Semi-long joysticks
- Control joysticks, with 3 switches ea.
- Control joysticks, with 5 switches ea.

Cab and interior

Fabric seat
Fabric seat, with heater
Fabric seat, with heater and air suspension

Digging equipment

Boom: 5.2 m monobloc
4.97 m 2-piece
Arm: 2.3 / 2.6 / 3.1 m

Undercarriage

Single tires, 18.00 X 22.5
Double tires, 10.00-20PR14
Stone protection rings
Front equipment: dozer blade, outriggers, clamshell rest, 4 outriggers
Rear equipment: dozer blade, outriggers

OPTIONAL EQUIPMENT (Standard in certain markets)

Engine

Alternator, 70A
Block and oil pan heater: 120V, 240V
Fuel warmer
Tropical kit

Electronic control system

Pump flow control for hammer
Extra work lights-4:
- Cab-mounted 3, (front 2, rear 1)
- Counterweight-mounted 1

Hydraulic system

Hydraulic piping
- Hammer & shear for monobloc boom
1 pump flow / 2 pump flow
Extra piping for rotate/slope
Pump flow control
- Rotate/slope
Volvo hydraulic quick fit- S1 size
Hydraulic oil, ISO VG 32
Hydraulic oil, ISO VG 68

Superstructure

Low noise kit

Cab and interior

Cab-mounted falling object protective structures (FOPS)
Steel roof hatch
Safety mesh for front window
Anti-vandalism kit
Sliding rear window

Service

Hand lamp
Spare parts
Tool kit

Under our policy of continuous improvement, we reserve the right to change specifications and design without prior notice. The illustrations do not necessarily show the standard version of the machine.

VOLVO

Volvo Construction
Equipment Group

Ref. No. 21 3 435 1626 English, global
Printed in Korea 2000.06-1 KOR
Volvo, Seoul