

VOLVO WHEEL LOADER

L60E



VOLVO

L60E – ONE MACHINE, EXCELLENT FLEXIBILITY

The Volvo L60E gives flexibility a whole new meaning. L60E is the machine with a wide application range. It operates smoothly and quietly in tight areas, and is at the same time a highly reliable "all-rounder". L60E has the required power and flexibility for operations in construction, industrial applications, saw mills, agriculture and a variety of other sites. All by itself, the L60E makes an easy job of any task where our competition often needs two machines to get the job done.

Volvo has developed and manufactured wheel loaders for half a century. The latest experiences and leading technology have been used in designing the L60E. It is the true all-round machine, giving you countless possibilities to expand your application range. With the Volvo engine and Automatic Power Shift (APS) gearshifting system, you get optimal performance and low fuel consumption in all types of applications. The Torque Parallel linkage, hydraulic attachment bracket and wide range of Volvo genuine attachments further increase the machine's versatility.

Get more done

You'll find the L60E a pleasure to operate. In this respect, competing loaders simply can't compete. It's powerful, agile and easy to maneuver. Sitting comfortably in an ergonomically designed seat, you have total control over the machine. Engine and hydraulics respond immediately to your commands. Visibility is panoramic and the air in the cab is always fresh. Both operator and machine get more done with a lot less haste.

A great deal for your investment

Proven reliability, excellent financing, extremely low fuel consumption and a high trade-in value provide the cornerstones of a safe investment. Add to that outstanding handling and productivity, a market-leading operator environment to protect the person in the machine, quick and simple daily maintenance and modest service requirements.

And what do you get? The most cost efficient loader in its class, delivering unparalleled profitability — both now and in years to come.

With the L60E, everybody is a winner. Quite simply, a great deal for your money.



Specifications L60E

Engine:	Volvo D6D LC E2
Max power at SAE J1995 gross ISO 9249, SAE J1349 net	30,0 r/s (1800 rpm) 103 kW (140 hp) 102 kW (139 hp)
Breakout force:	87,8 kN*
Static tipping load at full turn:	7 100 kg*
Buckets:	1,7 – 5,0 m ³
Log grapple:	0,7 – 1,3 m ²
Operating weight:	11,0 – 12,3 t
Tires:	17.5 R25, 20.5 R25 600/65 R25

* Bucket: 1,9 m³ straight edge with bolt-on edges.
Tires: 20.5 R25 L2. Standard boom.



POWER UP YOUR PRODUCTIVITY

Load more tons per hour with the Volvo L60E. Its powerful engine and the Automatic Power Shift (APS) gear shifting system provide immediate response even in the toughest conditions. And Volvo axles are designed to ensure that the rimpull is there when needed. Torque Parallel linkage (TP linkage), load sensing hydraulics, smooth steering and stable operation help make the L60E a precision performer.

Volvo engine delivers rapid response for faster work cycles

L60E is equipped with Volvo's 6-liter engine, correctly matched to the Volvo transmission, axles and hydraulic system for unbeatable productivity and economy. The electronically controlled engine transmits high torque at low engine speeds for faster work cycles and fuel efficient operation.

Responds to your commands

The Volvo automatic countershaft transmission provides smooth and effective gear shifting. All the operator has to do is select forward, reverse or kickdown and APS automatically selects the right gear according to both engine rpm and ground speed. Volvo's in-house engineered axles and drivetrain are well matched and designed for top dependability. And Volvo's oil circulation cooled wet disc brakes provide smooth, effective braking — and, of course, a long service life.

Torque Parallel linkage — a breakthrough in the industry

The reliable TP linkage, Volvo's patented lift-arm system, delivers high and even breakout torque throughout the entire lifting range. The system is exceedingly user-friendly. The operator can easily handle heavy materials and maintain full control in all positions. In addition, TP linkage provides excellent parallel movement, making it possible for the L60E to perform well in applications where other manufacturers need two different machine types.

Hydraulics that make sense

The Volvo L60E features an intelligent load sensing system for both the main and steering hydraulics. One variable piston pump provides the exact flow and pressure required at any given moment, distributing power when and where it's needed. In addition to rapid response, this system facilitates smoother operation, lower fuel consumption, and precise control, even at low rpm.

Engine

- Volvo D6D, a turbocharged, air-to-air intercooled low emission engine with electronically controlled fuel injection delivers high torque even at low rpm.
- The electronically controlled hydrostatic fan is only activated when necessary, thus saving fuel.

Transmission

- Volvo's well proven countershaft transmission provides optimal performance in all applications.
- With Volvo's 3rd generation of APS, the operator can select between four different operating modes, including the new AUTO function, which adaptively chooses the most convenient shifting program for the job at hand, equally weighing the operator's driving habits together with the operating cycle.

Axles/Brakes

- The Volvo axles are fully integrated with the drivetrain, delivering superior rimpull.
- Oil circulation cooled wet disc brakes ensure effective braking and a long service life.
- An electronic brake test in Contronic gives you instant access to the status of the brakes.
- A brake wear indicator on each wheel allows you to easily check the brake pad wear.

Steering

- Load-sensing steering only uses power when it's needed, thereby saving fuel.
- E-series loaders feature an accumulator system, providing stable, smooth steering and greater safety.

Frame

- Rugged frame design for secure mounting of components increases the service life of the machine.
- Volvo's frame joint bearing design is a well-proven concept that's easy to maintain and renowned for its long service life.



TP linkage

- Unique patented lift-arm system, which provides two solutions in one: excellent breakout torque and parallel action throughout the entire lifting range.

Load-sensing hydraulics

- The load-sensing hydraulic system ensures that hydraulic oil is pumped around the system only when and where it's needed. This means greater efficiency and lower fuel consumption.

- Pilot-operated hydraulics allow precise control of the attachments, making life easier, and safer, for the operator.

AN ALERT OPERATOR IS A PRODUCTIVE OPERATOR

Volvo Care Cab with the Contronic monitoring system reinforces Volvo's reputation as a leader in operator environments and cab comfort. We never forget the operator inside the machine. A comfortable, operator-friendly and safe environment makes the workday easier and more productive.



A clean and comfortable workplace

The right cab climate does wonders for efficiency, keeping operators sharp during long shifts. In fact, all incoming air is filtered in two stages, making this one of the cleanest cabs on the market. Even the recirculated air is filtered. Furthermore, Volvo's state-of-the-art air-conditioning* provides a pleasant temperature year-round, regardless of outdoor conditions. So even after a long work shift, the air in the cab is still fresh and the operator's mind is still clear.

Comfort and productivity go hand-in-hand

There is a range of comfortable seats, all of them with multiple adjustment functions for optimal individual comfort. All instruments are visible at a glance, and all important information is right in front of the operator. The forward, reverse and kick-down functions are situated both on the lever on the left-hand side of the steering wheel and on the hydraulic console to the right. And thanks to Comfort Drive Control (CDC)*, you can steer, change directions and kickdown to first gear with easy-to-use controls integrated into the left-hand armrest — an excellent way to combat fatigue and static muscle strain. Furthermore, to avoid monotonous arm movements, you can shift at any time from lever steering to using the steering wheel.

Contronic keeps an eye on everything

Contronic, the highly reliable control and monitoring system from Volvo, continuously monitors the machine's operation and performance. The system is an electronic network made up of three computers. Operating at three levels, the system keeps an eye on the machine's various functions in real-time. If a potential problem should occur, the system generates an immediate warning, making the operator aware of the condition. All operating data is saved and can be used to analyze how the machine performs and also to trace its history since the latest service. The machine's functions can be updated for optimal adaptation to new and changing operating conditions via the Contronic service display tool. With VCADS Pro, it's also possible to check and adjust the machine's functions and performance characteristics.

Low noise levels

Thanks to its ingenious rubber mounting system and heavy-duty insulation, the Care Cab is one of the quietest cabs on the market. By reducing tiresome earfuls and annoying vibrations, the operator will stay sharp throughout the shift. In short, it's a great place to work.

Care Cab

- Unrivalled operator environment with one of the market's best cab filtration systems.
- Pleasant interior with superior finish makes it easy to maintain and keep clean.
- Adjustable seat, armrest, hydraulic lever console and steering wheel* for optimal operator comfort and high production.
- Contronic, a superior control and monitoring system, designed to increase safety and productivity.
- All service platforms and entry ladders boast improved anti-slip surfaces. Sloped entry ladder for easy cab access.
- Large windscreens, narrow pillars and a sloped engine hood ensure good panoramic visibility, thus further increasing safety.
- Powerful halogen lighting to the front and rear provides good visibility over the entire work area.

* Optional equipment



VOLVO'S COMMITMENT TO NATURE AND MANKIND

Quality, safety, and care for the environment are Volvo's core values. Indeed, we see our commitment as an integral part of our operation. Few machines have to work in tougher conditions. The ultimate goal is maximized productivity and efficiency for the lowest cost per hour, with minimized environmental impact. For instance, plants and manufacturing processes are certified in accordance with ISO 14001. This is but one example of our tangible commitments and high quality standards. And that's why Volvo customers get one of the most environmentally considerate and dependable wheel loaders on the market.

A winner for years to come

Your Volvo L60E has to be a winner — both in day-to-day and long-term operations, always operating economically with maximum consideration of the environment. The machinery has to be trusted in all aspects. It must deliver the anticipations of productivity and economy. High quality and easy maintenance are imperative for keeping up the work process. The high performance low emission engine is both good for your business and for the environment.

Comfortable and quiet operator's environment

The operator inside deserves a comfortable, reliable and safe machine to work with. A good environment helps to spare operator, equipment and nature for years to come. The Volvo L60E is a super competitive wheel loader that puts the operator right in the middle, literally speaking. Tedious vibrations and noise have been heavily reduced. If the operator feels comfortable and secure, it's easier to stay attentive.

More than 95% recyclable

The L60E is almost completely recyclable. We see it as a natural step in our commitment. Components such as the engine, transmission and hydraulics are re-engineered and re-used in our Parts Exchange program. The equipment has to be as trustworthy, service-friendly, productive and as cost-effective as possible. Choose this wheel loader for maximum productivity and minimal impact on operator, machinery and environment. Feel free to feel secure in a Volvo L60E.

Quality

- The air is vented from all major components with easy to replace breather filters, used to prevent dirty air from entering the transmission, axles, fuel tank, and hydraulic tank.
- All electrical wires are routed through sturdy conduits, protected from water, dust, and abrasion with rubberized connectors and terminal caps.
- The L60E is designed from the beginning for easy service and maintenance. Easy access to all components lays the foundation for shorter service and maintenance time and longer life.

Safety

- A dual-circuit service brake system that fulfills all requirements according to ISO 3450, electronic brake test in Contronic and easy to check brake wear indicators are all ways to ensure safe and effective braking.
- Volvo Care Cab is tested and approved according to ROPS ISO 3471 and FOPS ISO 3449 standards.
- Optimized panoramic visibility gives effective control over the entire work area.
- The L60E has steps and platforms that are equipped with anti-slip surfaces and well positioned hand rails.

Environment

- The low rpm, high performance D6D engine meets all current emission requirements according to stage 2 legislation in Europe and the US.
- The L60E is manufactured in environmentally certified factories according to ISO 14001.
- The L60E is more than 95% recyclable according to material weight.
- Low external and internal sound levels.



VOLVO L60E IN DETAIL

Engine

6 liter, 6-cylinder straight turbocharged diesel engine with electronically controlled unit pumps and conventional injectors. The engine has dry replaceable cylinder liners and replaceable valve guides and valve seats. The throttle application is transmitted electrically from the throttle pedal or the optional hand throttle. Air cleaning: three-stage. Cooling system: Air-to-air intercooler and hydrostatic, electronically controlled fan.

Engine	Volvo D6D LC E2
Max power at	30,0 r/s (1800 r/min)
SAE J1995 gross	103 kW (140 hp)
ISO 9249, SAE J1349	102 kW (139 hp)
Max torque at	28,3 r/s (1700 r/min)
SAE J1995 gross	570 Nm
ISO 9249, SAE J1349	564 Nm
Economic working range	1100–1600 r/min
Displacement	5,7 l

Electrical system

Central warning system: Central warning light for the following functions, (buzzer with gear engaged): Engine oil pressure, charge-air temperature, fuel temperature, transmission oil pressure, brake pressure, parking brake applied, hydraulic oil level, steering pressure, low coolant level, coolant temperature, transmission oil temperature, hydraulic oil temperature, overspeeding in engaged gear, brake charging.

Voltage	24 V
Batteries	2x12 V
Battery capacity	2x110 Ah
Cold cranking capacity, approx	690 A
Reserve capacity, approx	206 min
Alternator rating	1540 W/55 A
Starter motor output	5,4 kW (7,3 hp)

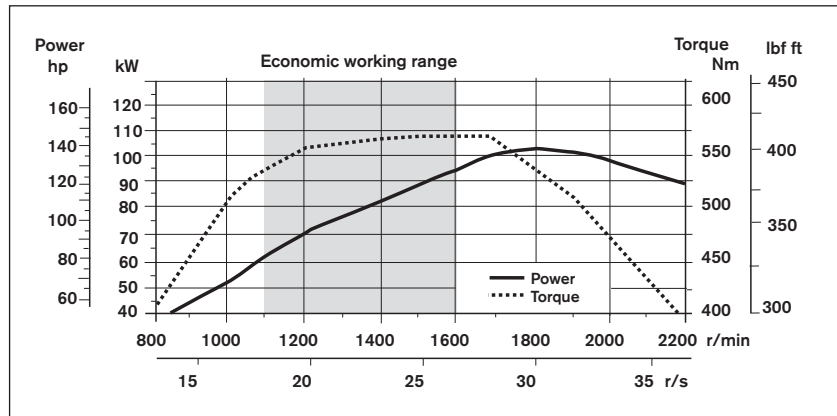

Drivetrain

Torque converter: single-stage. Transmission: Volvo countershaft transmission with single lever control. Fast and smooth shifting of gears between forward and reverse. Gearshifting system: Volvo Automatic Power Shift (APS) with mode selector and 4 different gearshifting programs, including AUTO. Axles: Volvo fully floating axle shafts with planetary hub reductions and cast steel axle housings. Fixed front axle and oscillating rear axle. 100% differential lock on the front axle.

Transmission	Volvo HTE 93
Torque multiplication	2,85:1
Maximum speed, forward/reverse	
1	7,2 km/h
2	13,8 km/h
3	25,6 km/h
4	43,1 km/h*
Measured with tires	20,5 R25 L2
Front axle/rear axle	Volvo/AWB 15/15
Rear axle oscillation	±13°
Ground clearance at 13° osc.	470 mm

* local restrictions may apply

Brake system

Service brake: Volvo dual-circuit system with nitrogen charged accumulators. Outboard mounted hydraulically operated, fully sealed oil circulation-cooled wet disc brakes. The operator can select automatic disengagement of the transmission when braking using Contronic. Parking brake: Dry disc brake mounted on the transmission output shaft. Applied by spring force and released by oil pressure with a switch on the instrument panel. Secondary brake: Dual brake circuits with rechargeable accumulators. Either one circuit or the parking brake fulfills all safety requirements. Standard: The brake system complies with the requirements of ISO 3450.

Number of brake discs per wheel front/rear	1/1
Accumulators	3x0,5 l

Steering system

Steering system: Load-sensing hydrostatic articulated steering. System supply: The steering system has priority feed from a load-sensing axial piston pump with variable displacement. Steering cylinders: Two double-acting cylinders.

Steering cylinders	2
Cylinder bore	70 mm
Piston rod diameter	45 mm
Stroke	386 mm
Working pressure	21 MPa
Maximum flow	145 l/min
Maximum articulation	±40°

Cab

Instrumentation: All important information is centrally located in the operator's field of view on the Contronic monitoring system's display unit. Heater and defroster: Heater coil with filtered fresh air and fan with four speeds. Defroster vents for all window areas. Operator seat: Ergonomic seat with adjustable suspension and retractable seatbelt. The seat is mounted on a bracket, which is mounted on the rear cab wall. The forces from the retractable seat belt are absorbed by the seat rail. Standard: The cab structure is tested and approved according to ROPS (ISO 3471) and FOPS (ISO 3449). The cab meets all requirements according to ISO 6055 (Operator Overhead Protection - Industrial Trucks) and SAE J386 (Operator Restraint System).

Emergency exits	1
Sound level in cab according to ISO 6396	LpA 70 dB (A)
External sound level according to ISO 6395 (Directive 2000/14/EC)	LwA 104 dB (A)
Ventilation	9 m ³ /min
Heating capacity	11 kW
Air conditioning (optional)	8 kW

Hydraulic system

System supply: One load-sensing axial piston pump with variable displacement. The steering system always has priority. Valves: Double-acting 2-spool valve. The main valve is controlled by a 2-spool pilot valve. Lift function: The valve has four positions including lift, hold, lower and float. Inductive/magnetic automatic boom kick-out can be switched on and off and is adjustable to any position between maximum reach and full lifting height. Tilt function: The valve has three functions including rollback, hold and dump. Inductive/magnetic automatic tilt can be adjusted to the desired bucket angle. Cylinders: Double-acting cylinders for all functions. Filter: Full flow filtration through 20 micron (absolute) filter cartridge.

Working pressure maximum	26,0 MPa
Flow at and engine speed	145 l/min 10 MPa 32 r/s (1900 r/min)
Pilot system Working pressure	3,5 MPa
Cycle times	
Lift*	4,5 s
Tilt*	2,3 s
Lower, empty	2,9 s
Total cycle time	9,7 s

* with load as per ISO 14397 and SAE J818

Lift arm system

Torque Parallel linkage (TP linkage) with high breakout torque and parallel action throughout the entire lifting range.

Lift cylinders	2
Cylinder bore	110 mm
Piston rod diameter	70 mm
Stroke	665 mm
Tilt cylinder	1
Cylinder bore	150 mm
Piston rod diameter	80 mm
Stroke	444 mm

Service

Service accessibility: Large, easy-to-open service doors with gas struts. Swing-out radiator grille and cooling fan. Possibility to log and analyze data to facilitate troubleshooting.

Refill capacities

Fuel tank	197 l
Engine coolant	30 l
Hydraulic oil tank	105 l
Transmission oil	18 l
Engine oil	20 l
Axles front/rear	24/24 l

SPECIFICATIONS

Tires: 20.5 R25 L2

	Standard boom	Long boom
B	5960 mm	6480 mm
C	3000 mm	—
D	450 mm	—
F	3200 mm	—
G	2130 mm	—
J	3580 mm	4100 mm
K	3870 mm	4380 mm
O	56 °	57 °
P _{max}	45 °	44 °
R	42 °	43 °
R ₁ *	47 °	49 °
S	79 °	—
T	93 mm	130 mm
U	400 mm	530 mm
X	1900 mm	—
Y	2440 mm	—
Z	3200 mm	3600 mm
a ₂	5340 mm	—
a ₃	2900 mm	—
a ₄	±40 °	—

* Carry position SAE

Tires: 20.5 R25 L2

A*	1800 kg
B*	1400 kg
C*	1150 kg
D	2580 mm
E	1990 mm
F	1450 mm
G	3270 mm
H	4300 mm
I	5440 mm
J	910 mm
K	1240 mm
L	1590 mm
M	2250 mm
N	3240 mm
O	4310 mm
P	1510 mm
Q	5290 mm
R	6180 mm
S	7150 mm

Order no.: 92007
Operating weight: 11 210 kg







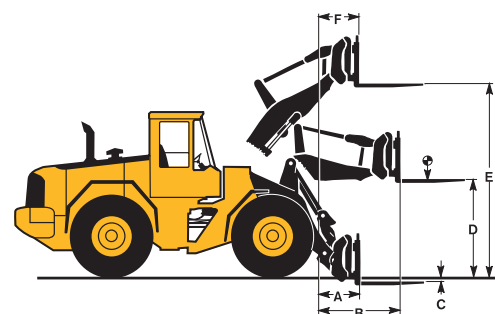
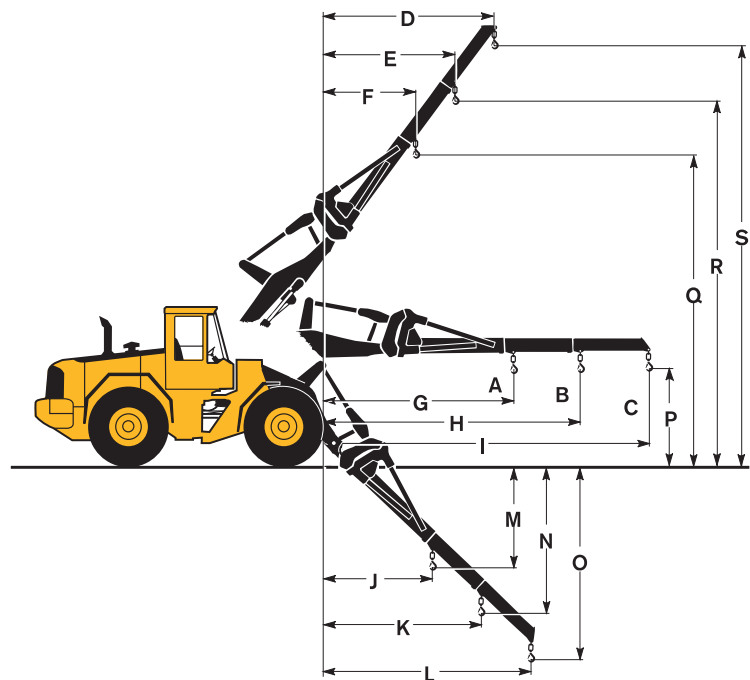
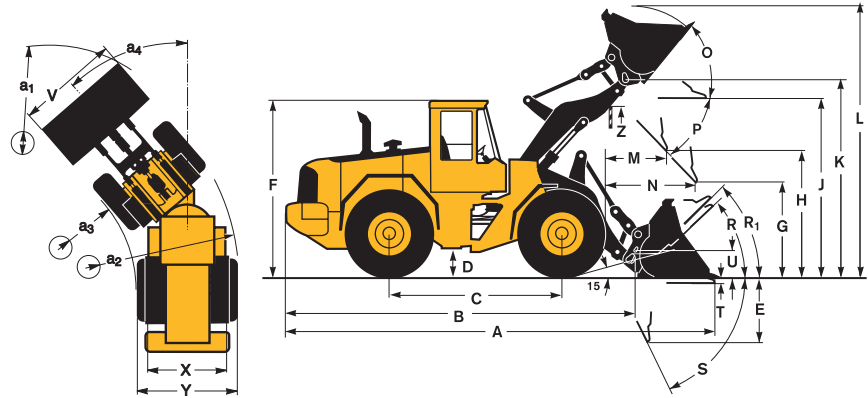

Tires: 20.5 R25 L2

A	800 mm
B	1560 mm
C	-40 mm
D	1830 mm
E	3710 mm
F	690 mm

Fork tine order no. (R/L): 93525/93526
Length: 1200 mm
Fork frame order no.: 80041
Width: 1500 mm
Rated operating load*: 4220 kg
at load rated distance: 600 mm
Operating weight: 11 270 kg
* acc. std EN 474-3, firm and level ground

Where applicable, specifications and dimensions are according to ISO 7131, SAE J732, ISO 7546, SAE J742, ISO 14397, SAE J818.







Tires 20.5 R25 L2	GENERAL PURPOSE						GRADING	LIGHT MATERIAL		LONG BOOM	
	 Bolt-on edges	 Teeth	 Bolt-on edges	 Bolt-on edges	 Bolt-on edges	 Bolt-on edges		 Bolt-on edges	 Bolt-on edges		
Volume, heaped ISO/SAE	m ³	1,7	1,8	1,9	1,9	2,1	2,1	1,6	3,1	5,0	—
Volume at 110% fill factor	m ³	1,9	2,0	2,1	2,1	2,3	2,3	1,8	3,4	5,5	—
Static tipping load, straight	kg	7770	7840	8160	7690	8140	7670	6860	7270	7230	-1620
at 35° turn	kg	6970	7030	7340	6880	7310	6860	6150	6490	6420	-1490
at full turn	kg	6730	6790	7100	6650	7070	6620	5940	6260	6180	-1460
Breakout force	kN	85,5	84,5	87,8	80,2	87,8	80,3	62,5	61,8	53,9	+9,0
A	mm	7210	7400	7190	7290	7190	7290	7520	7640	7860	+520
E	mm	1070	1250	1040	1140	1040	1140	1340	1480	1700	+40
H*)	mm	2850	2730	2870	2810	2870	2810	2570	2580	2440	+530
L	mm	5050	5110	5060	5110	5160	5210	4530	5280	5480	+520
M*)	mm	990	1140	970	1040	970	1040	1090	1320	1500	-7,0
N*)	mm	1560	1640	1550	1580	1550	1580	1500	1620	1670	+440
V	mm	2500	2500	2500	2500	2550	2550	2500	2550	2650	—
a, clearance circle	mm	11 560	11 660	11 550	11 590	11 600	11 640	11 920	11 830	12 060	—
Operating weight	kg	11 560	11 540	11 340	11 600	11 390	11 650	11 480	11 780	12 070	+160

*) Measured to the tip of the bucket teeth or bolt-on edge. Dump height to bucket edge. Measured at 45° dump angle.

Note: This only applies to genuine Volvo attachments.

Bucket Selection Chart

The chosen bucket is determined by the density of the material and the expected bucket fill factor. The actual bucket volume is often larger than the rated capacity, due to the features of the TP linkage, including an open bucket design, good rollback angles in all positions and good bucket filling performance. The example represents a standard boom configuration. **Example: Sand and gravel. Fill factor ~ 105%. Density 1,7 t/m³. Result: The 1,7 m³ bucket carries 1,8 m³. For optimal stability always consult the bucket selection chart.**

Material	Bucket fill, %	Material density, t/m ³	ISO/SAE bucket volume, m ³	Actual volume, m ³
Earth/Clay	~ 110 	~ 1,60	1,7	~ 1,9
		~ 1,50	1,9	~ 2,1
Sand/Gravel	~ 105 	~ 1,35	2,1	~ 2,3
		~ 1,70	1,7	~ 1,8
		~ 1,60	1,9	~ 2,0
Aggregate	~ 100 	~ 1,45	2,1	~ 2,2
		~ 1,80	1,7	~ 1,7
		~ 1,70	1,9	~ 1,9
Rock	≤100 	~ 1,50	2,1	~ 2,1
		~ 1,70	1,6	~ 1,6

The size of rock buckets is optimized for optimal penetration and filling capability rather than the density of the material.

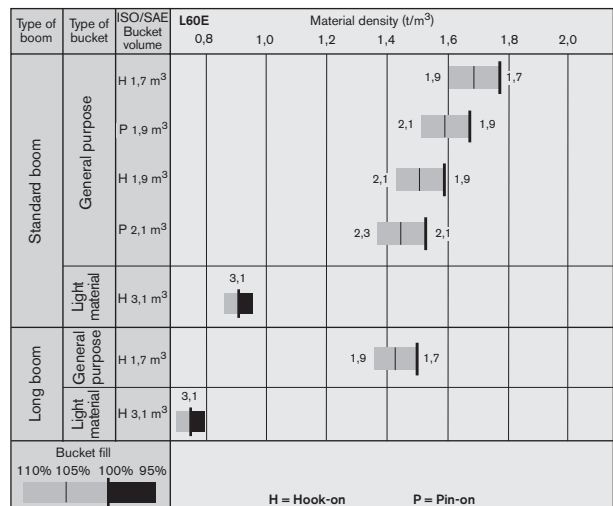

Supplemental Operating Data

Tires 20.5 R25 L2	Standard boom			
	17.5 R25 L2	600/65 R25	600/65 R25	
Width over tires	mm	-130	+60	+60
Ground clearance	mm	-60	-20	-10
Tipping load, full turn	kg	-310	+80	+150
Operating weight	kg	-560	+30	+240

STANDARD EQUIPMENT

Engine

Three stage air cleaner with ejector and inner filters
Indicator glass for coolant level
Preheating of induction air
Muffler, spark arresting
Fuel filter extra large with water trap
Oil trap

Electrical system

24 V, pre-wired for optional accessories
Alternator, 24 V/55 A
Battery disconnect switch
Fuel gauge
Temperature gauge, transmission oil
Temperature gauge, engine coolant
Hour meter
Electric horn
Instrument panel with symbols

Lighting:

- Twin halogen front headlights with high and low beams
- Parking lights
- Double brake and tail lights
- Turn signals with flashing hazard light function
- Halogen work lights (2 front and 2 rear)
- Instrument lighting

Contronic monitoring system

ECU with log and analysis system
Contronic display
Fuel consumption
Ambient temperature
Engine 'Shutdown to idle' in case of malfunction indication:

- High engine coolant temperature
- Low engine oil pressure
- High transmission oil temperature

Start interlock when gear is engaged
Brake test
Test function for warning and indicator lights
Warning and indicator lights:

- Battery charging
- Oil pressure engine

- Oil pressure, transmission
 - Brake pressure
 - Parking brake
 - Hydraulic oil level
 - Primary steering
 - Secondary steering
 - High beams
 - Turn signals
 - Work lights
 - Rotating beacon
 - Preheating coil
 - Differential lock
 - Coolant temperature
 - Transmission oil temperature
 - Low fuel level
 - Brake system pressure
- Level warnings:
- Coolant level
 - Hydraulic oil level
 - Washer fluid level

Drivetrain

Automatic Power Shift with operator-controlled disengagement function for transmission cut-out when braking and mode selector with AUTO function
Transmission modulated with single lever control
Forward and reverse switch by lever console
Differentials: front: 100% hydraulic diff lock
rear: conventional

Brake system

Wet oil circulation-cooled disc brakes on all four wheels
Dual brake circuits
Dual service brake pedals
Secondary brake system
Parking brake, el-hydraulic
Brake wear indicator

Cab

ROPS (ISO 3471), FOPS (ISO 3449)
Single key kit door/start
Acoustic inner lining
Ashtray

Cigarette lighter
Lockable door
Cab heating with filter, fresh air inlet and defroster
Floor mat
Interior light
Two interior rear-view mirrors
Two exterior rear-view mirrors
Openable window right side
Tinted safety glass
Lap-type retractable seatbelt (SAE J386)
Adjustable hydraulic lever console
Ergonomically designed operator's seat with adjustable suspension
Storage compartment
Sun visor
Beverage holder
Windshield washers front and rear
Windshield wipers front and rear
Interval function for front and rear windshield wipers
Service platforms with anti-slip surfaces on rear fenders
Speedometer

Hydraulic system

Main valve, 2-spool
Pilot valve, 2-spool
Variable displacement axial piston pumps (2) for:

- steering system, pilot hydraulics, working hydraulics and brakes
- fan motor

Boom lowering system
Boom kick-out, automatic, adjustable
Bucket positioner, automatic with position indicator, adjustable
Hydraulic oil cooler

External equipment

Noise and vibration dampening suspension of cab, engine and transmission
Lifting eyes
Tie-down eyes
Easy-to-open side panels
Mudguards (for 17.5 R25 and 20.5 R25 tires)
Frame steering, joint lock
Vandalism lock prepared for batteries and engine compartment
Tow hitch

OPTIONAL EQUIPMENT

(Standard on certain markets)

Service and maintenance

Tool box, lockable
Tool kit
Wheel nut wrench kit
Automatic lubrication system
Automatic lubrication system, stainless steel
Automatic lubrication system incl. long boom
Automatic lubrication system for attachment bracket, cast
Autom. lubr. system, stainless steel, for attachment bracket, cast
Refill pump for automatic lubrication system
Oil sampling valve

Engine equipment

Engine block heater 230 V
Engine auto shutdown
Air pre-cleaner, oil-bath type
Air pre-cleaner, turbo type
Air pre-cleaner, Sy-Klone type
Hand throttle control
Fuel fill strainer
Coolant filter
Exhaust heat insulation
Radiator, hydr. oil cooler and fuel cooler, corrosion-protected
Fan air intake protection
Reversible cooling fan

Electrical system

Alternator, 80 A with air filter
Work light, attachments
Work lights front, extra
Work lights rear, extra
Work lights front, on cab, dual
Work lights front, high intensity
License plate holder, lighting
Asymmetrical lights for left-hand traffic
Back-up alarm
Back-up lights, automatic
Rotating beacon, collapsible
Battery disconnect switch, additional in cab
Side running lights
Anti-theft device

Cab

Installation kit for radio, 11 A, 12 V, left/right in cab
Radio with tape recorder
Radio with CD-player
Sun blinds, front and rear windows
Sun blinds, side windows
Sliding window, right
Sliding window, door
Retractable lap-type belt, longer and wider than standard
Air conditioning
Air conditioning with corrosion-protected condenser

Air conditioning with ATC
Air conditioning with ATC and corrosion-protected condenser
Fan for AC condenser
Ventilation air filter for work in asbestos environment
Cab air pre-cleaner, Sy-Klone type
Operator's seat with low backrest
Operator's seat with electrical heating
Operator's seat with low backrest and electrical heating
Operator's seat with high backrest and electrical heating
Operator's seat, air suspended, heavy-duty
Operator's seat, air suspended with electrical heating
Operator's seat air-suspended with high backrest and electrical heating
Instructor's seat
Armrest (left) for operator seat
Adjustable steering wheel
Steering wheel knob
Noise reduction kit
Rear-view camera incl. monitor
Rear view camera incl. monitor, colour
Rear-view mirrors, el. heated
Foot step, right side (toolbox lockable included)
Foot steps, front frame
Cab ladder, rubber suspended

Drivetrain

Limited slip rear
Speed limiter 20 km/h
Speed limiter 30 km/h
Wheel/axle seal guards

Brake system

Parking brake alarm, audible

Hydraulic system

Single lever control
Single lever control for 3rd hydraulic function
3rd hydraulic function
3rd hydraulic function for long boom
3rd-4th hydraulic function
3rd-4th hydraulic function for long boom
Adjustable flow for 3rd hydraulic function
Detent for 3rd hydraulic function
Boom Suspension System (BSS)
Single acting lifting function
Biodegradable hydraulic fluid
Fire resistant hydraulic fluid
Hydraulic fluid for hot climate
Attachment bracket, cast
Attachment bracket, side-tilting
Attachment bracket, side-tilting adapter
Mounting kit for side-tilting adapter
Separate attachment locking, standard boom
Separate attachment locking, long boom
Arctic kit, attachment locking hoses
Arctic kit, pilot hoses and brake accum. incl. hydraulic oil

External equipment

Long boom
Mudguards front/rear for 600/65 R25 tires
Mudguards full coverage for 17.5 R25 and 20.5 R25 tires
Mudguards full coverage for 600/65 R25 tires
Mudflap kit for mudguards
Deleted front mudguards and rear wideners
Logging counterweight

Protective equipment

Guards for front headlights
Guards for tail lights
Guards for tail lights, heavy-duty
Guards for side and rear windows
Guard for radiator grille
Windshield guard
Cover plate, front frame, heavy-duty
Cover plates, rear frame
Cover plate under cab
Guard for center hinge and rear frame
Belly guard front
Belly guard rear
Guards for boom cylinder hose and tube
Corrosion-protection, painting of machine
Corrosion-protection, painting of attachment bracket
Bucket teeth protection

Other equipment

Comfort Drive Control, (CDC)
Secondary steering
Sign, slow moving vehicle
Sign 50 km/h
Noise reduction kit, EU
Sound decal, EU
CE-marking

Tires

17.5 R25, 20.5 R25, 600/65 R25

Attachments

Buckets:

- Straight with teeth or bolt-on edges
- Spade nose
- High tipping
- Light materials
- Grading

Bolt-on or weld-on bucket teeth
Cutting edge in three sections, bolt-on, reversible
Fork equipment
Material handling arm
Log grapples
Snow blade
Broom
Sand spreading bucket
Bale clamp
Drum rotator

Boom Suspension System (BSS)*

BSS utilizes gas/oil accumulators connected to the lift cylinders to absorb shocks and smooth out rough roads for faster cycle times, less spillage and increased operator comfort.



Automatic Lubrication System*

Our factory fitted Automatic Lubrication System takes care of greasing while the machine is in operation. This means less downtime for scheduled maintenance and more time for productive work.



Comfort Drive Control (CDC)*

CDC significantly reduces repetitive and tiring steering wheel movements. The operator can shift and steer easily with the aid of controls integrated in the left armrest.



3rd and 4th hydraulic functions*

Volvo wheel loaders can be equipped with third and fourth hydraulic functions, which are operated with additional control levers. These functions are necessary when there's a need to operate a third and fourth hydraulic function at the same time, such as when using a sweeper attachment or a timber grapple with hydraulic heel kick-out.

* Optional equipment



Genuine Volvo attachments

Genuine Volvo attachments and wear parts, including the new Volvo Tooth System, are designed as an integral part of the loader, making the L60E a swift and versatile machine in a wide range of applications.

Long boom*

A long boom gives the extra dump height and reach necessary for loading high trucks or feeders.





Volvo Construction Equipment is different. It's designed, built and supported in a different way. That difference comes from an engineering heritage of over 170 years. A heritage of thinking first about the people who actually use the machines. About how to help them be safer, more comfortable, more productive. About the environment we all share. The result of that thinking is a growing range of machines and a global support network dedicated to helping you do more. People around the world are proud to use Volvo. And we're proud of what makes Volvo different – **More care. Built in.**



All products are not available in all markets. Under our policy of continuous improvement, we reserve the right to change specifications and design without prior notice. The illustrations do not necessarily show the standard version of the machine.

VOLVO

Construction Equipment
www.volvo.com

Ref. No. 21 B 100 1560
Printed in Sweden 2005.12-3,0
Volvo, Eskilstuna

English
WLO