

VOLVO WHEEL LOADERS
ATTACHMENTS



VOLVO

MACHINE AND ATTACHMENTS MADE FOR ONE ANOTHER

Our wheel loaders and attachments are literally made for one another. That's why they work best when they are put together. Only then can you exploit the full capacity of machine and attachment alike. So if you've decided to go for a Volvo wheel loader, you should never accept anything less than Genuine Volvo attachments.

An integrated part of the wheel loader

All our attachments are of the same high quality as the machines themselves, and they are designed as an integrated part of the wheel loaders for which they are intended. Their functions and properties are precisely matched to parameters such as link-arm geometry and breakout, rim-pull and lifting force. The machine and attachment, therefore, work in perfect harmony with one another, forming a dependable cohesive unit that gets on with the job both safely and efficiently.

Good visibility enhances both productivity and safety

One of the preconditions for high productivity is good visibility. Volvo's attachment bracket and the attachments themselves are therefore designed to give the operator the best view possible over the attachment, load and surrounding area. This not only makes for a more efficient working climate, but it is also essential for ensuring the safety of the driver and the operational area.

Buckets for every need

Volvo's range of buckets is very comprehensive, encompassing buckets for all types of jobs and all types of materials; from rock and stone to ore and wood chips. The buckets are tough and last up to three times longer than some other makes.

Key Features

- With machine and attachments made for one another, maximum productivity is guaranteed
- A comprehensive range of attachments enhances versatility and efficiency
- Attachments of the highest quality guarantee high availability
- Volvo's attachment bracket and the attachments themselves are designed to give the operator the best view possible





A COMPREHENSIVE RANGE OF GENUINE VOLVO ATTACHMENTS

Through Volvo's comprehensive range of buckets, Genuine Volvo attachments and wear parts, you can equip your wheel loader to precisely meet your needs and operating conditions. This promotes both efficiency and flexibility.

Different jobs require different tools

Different jobs require different attachments, and it is important to always have the right attachment for the job at hand. Compromises make the work inefficient and may jeopardize safety.

Volvo is today the wheel loader manufacturer with the most comprehensive range of genuine attachments. Apart from buckets for every different type of application and material, we have log grapples, material-handling arms and a wide variety of fork attachments. Through close engineering and development cooperation with renowned and carefully selected suppliers, we can also offer snow plows, sweepers and other attachments specially tailored for Volvo. They naturally offer the same high quality as the items we produce ourselves.

Simple attachment exchange promotes flexibility

Many jobs require two or more attachments, but not necessarily more than one machine. Thanks to Volvo's wide range of attachments and the Volvo-designed hydraulic attachment bracket that is now most commonly used attachment locking standard in the world. The driver can quickly and easily switch between a number of tasks in one and the same machine without ever leaving the cab. The perfect link between bracket and Genuine Volvo attachment guarantees the highest possible safety, even when the work has to be done quickly.

Key Features

- Volvo offer buckets for every different type of material
- The perfect link between bracket and attachment guarantees high safety
- The driver can switch attachment without leaving the cab





HIGH QUALITY PROMOTES HIGH PRODUCTIVITY

Volvo's wheel loaders are renowned for their high quality and Volvo's Genuine attachments offer exactly the same high quality. This is an absolute precondition for our machines to deliver what we promise: the highest possible productivity.

Best penetration ability and long service life

Genuine Volvo attachments are durable and last up to three times as long as some other makes. This high quality stems partly from our long experience in the industry and partly from our close cooperation with some of the world's best material manufacturers. This high quality also applies to the buckets' wear

parts; their design and the materials from which they are made give Volvo's edge savers, teeth and segments the best penetration ability, long service life and short time for replacement of wear parts.

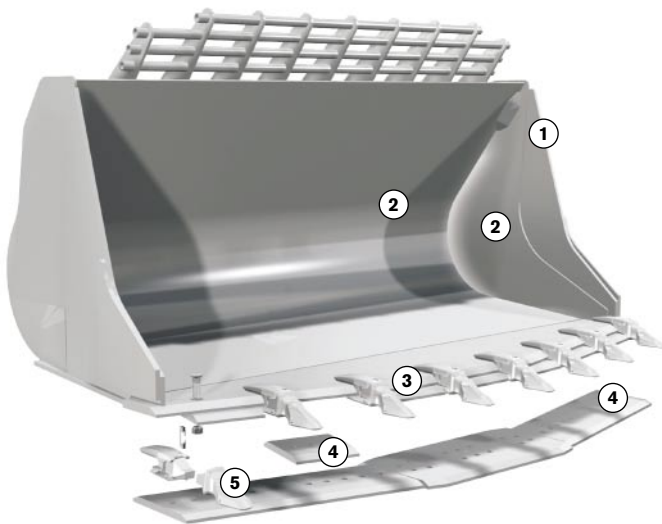

1. Side cutters with extra hardened and tempered steel wear plates provide high abrasion resistance (up to 500 Brinell)
2. Bucket shell and side plates (up to 400 Brinell)
Reinforced load transition structures reduce wear and increase useful life
3. Base cutting edge manufactured from abrasion resistant steel (500 Brinell)
Replacable bolt-on bottom wear plates (500 Brinell)
4. Bolt-on edge savers and segments help protect the cutting edge from excessive wear (500 Brinell)
5. Volvo Tooth System with bolt-on or weld-on adapters for excellent penetration and reduced bucket wear (up to 515 Brinell)





A perfect log handler



Volvo was building attachments for forestry work and log handling already back in the 1950s. Our accumulated wealth of experience gives us the competence and expertise required for developing log-handling attachments which, together with our wheel loaders, create the perfect combination.

In log-handling operations, breakout torque, reach and not least lift height are decisive factors. Considerable lift height and long reach make for short cycle times when unloading logs and pulpwood for placing in piles and sorting bins and on feed tables.

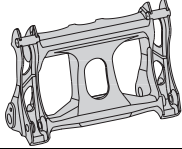
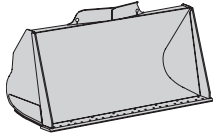
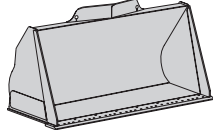
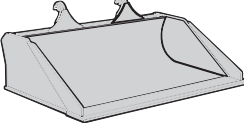
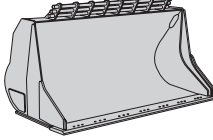
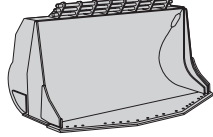
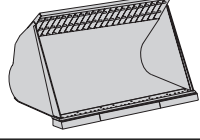
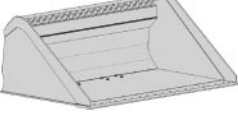

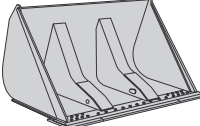
VOLVO ATTACHMENTS IN DETAIL

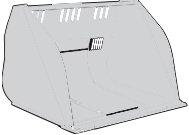
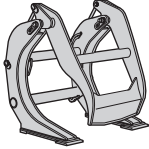
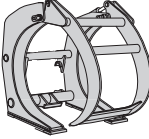
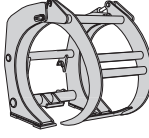
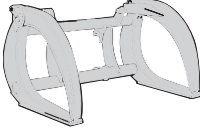
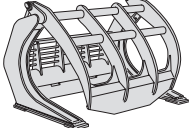
<p>Volvo Attachment Bracket</p> <p>Volvo Construction Equipment's industry-acclaimed attachment bracket system allows you to change attachments in only a matter of seconds, so from material handling, simplified by excellent visibility, to maximizing each bucket load per pass, the Volvo wheel loader and its more than 60 available genuine Volvo attachments make you the master of your trade.</p>	
<p>Volvo Attachments - Buckets</p> <p>Straight Edge General Purpose Bucket Capacities: 1.6-10.9 yd³ (1,2-8,3 m³) Machines: L50E - L330E Applications: general use, rehandling loose materials from stockpiles. Options: pin/hook-on, bolt-on edge, bolt-on/welded teeth & segments.</p>	
<p>Flat Floor Bucket Capacities: 1.8-4.4 yd³ (1,4-3,4 m³) Machines: L50E - L120E Applications: earthmoving, landscaping, stripping, grading, general use. Options: pin/hook-on, bolt-on edge, welded teeth.</p>	
<p>Grading & Landscaping Bucket Capacities: 2.1-2.7 yd³ (1,6-2,1 m³) Machines: L50E - L120E Applications: specific to landscaping, stripping, leveling and grading. Options: hook-on, bolt-on edge.</p>	
<p>Straight Edge Rock Bucket Capacities: 1.6-10.9 yd³ (1,2-8,3 m³) Machines: L70E - L330E Applications: loading easily broken material from banks. A sturdier material also used for shot rock; loading easily broken material from banks. Options: pin/hook-on, bolt-on edge, bolt-on/welded teeth & segments.</p>	
<p>Spade Nose Rock Bucket Capacities: 2.4-9.8 yd³ (1,8-7,5 m³) Machines: L50E - L330E Applications: hard and stony material, shot rock and where good penetration is needed. Options: pin/hook-on, bolt-on edge, welded teeth & segments.</p>	
<p>Refuse Bucket Capacities: 3.8-13.7 yd³ (2,9-10,5 m³) Machines: L60E - L220E Applications: waste, for truck loading or push floor operations. Options: pin/hook-on, steel or rubber bolt-on edges.</p>	
<p>Refuse Tamping Bucket Capacities: 6.8-8.4 yd³ (5,2-6,4 m³) Machines: L110E - L220E Applications: waste, ideal for push floor operations and tamping. Options: pin/hook-on, steel or rubber bolt-on edges.</p>	
<p>Refuse Tamping Bucket with Top Clamp Capacities: 6.8-8.4 yd³ (5,2-6,4 m³) Machines: L110E - L220E Applications: waste, ideal for push floor operations with up to 25% more material than standard refuse tamping bucket. Options: pin/hook-on, steel or rubber bolt-on edges.</p>	
<p>High Tip Light Material Bucket Capacities: 2.4-17.0 yd³ (1,8-13,0 m³) Machines: L50E - L220E Applications: loading low density materials; wood chips, coal, grain, etc. Exceptional dump clearance for high trucks and bins. Options: pin/hook-on, bolt-on edges are standard.</p>	

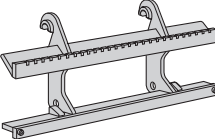
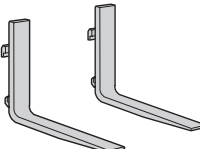
<p>Light Material Bucket Capacities: 2.9-17.7 yd³ (2,2-13,5 m³) Machines: L50E - L220E Applications: loading low density materials; wood chips, coal, grain, etc. Options: pin/hook-on, bolt-on edges are standard.</p>	
<p>Volvo Attachments - Log Grapples General Purpose Grapple Capacities: 7.5-19.4 ft² (0,7-1,8 m²) Machines: L50E - L220E Applications: an allround grapple for handling & sorting tree length stems or for gripping single stems. It has longer tines than the sorting grapple. Options: pin/hook-on, requires third function control.</p>	
<p>Sorting Grapple Capacities: 10.8-43.1 ft² (1,0-4,0 m²) Machines: L50E - L220E Applications: long & straight tines that can slide along the ground so the grapple can be easily filled when loading from stacks & sorting bunkers. Options: pin/hook-on, requires third function control.</p>	
<p>Unloading Grapple Capacities: 19.4-43.1 ft² (1,8-4,0 m²) Machines: L90E - L220E Applications: short, rounded tines, making it easier to fill the grapple when unloading a vehicle. Long, straight tines could damage both the timber & the vehicle if used for this purpose. Options: pin/hook-on, requires third function control.</p>	
<p>Tropical Timber Grapple Capacities: 11.8-17.2 ft² (1,1-1,6 m²) Machines: L110E - L180E Applications: a wide grapple with two separate clamping arms to hold large, heavy stems securely. Principally intended for handling large diameter & high-density timber. Options: pin/hook-on, requires third function control.</p>	
<p>Wide Tree Length Grapple (L150E - L220E) Capacities: 18.3-21.5 ft² (1,7-2,0 m²) Machines: L150E - L220E Applications: a wide grapple specifically designed for handling tree length stems. Options: pin/hook-on, requires third function control.</p>	
<p>Swivel Wood Clamp (L90E) Capacities: 5.4-21.5 ft² (0,5-2,0 m²) Machines: L90E - L120E Applications: unloading vehicles to a stack or feeding table. Options: hook-on, requires 3rd & 4th function.</p>	
<p>Volvo Attachments - Fork Attachments Pallet Fork Frame Widths: 59" (1500 mm), 67" (2000 mm, L50E-L90E only) & 87" (2200 mm) Machines: L50E - L220E Applications: material handling, visibility-optimized for maximum production. Options: hook-on, standard & heavy duty frames available.</p>	
<p>Pallet Fork Tines - Straight Lengths: 47" (1200 mm), 57" (1450 mm) & 72" (1830 mm) Machines: L50E - L220E Applications: material handling, optimized digging depth. Options: light, standard, heavy & lumber (wider) tines available.</p>	

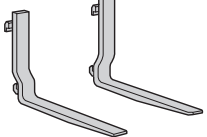
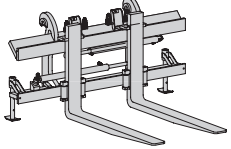
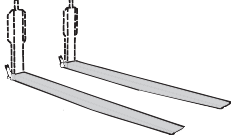
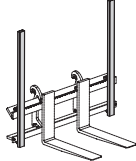
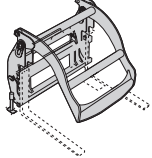
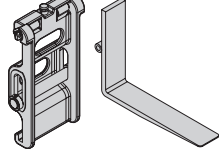
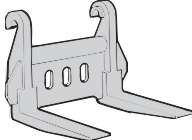
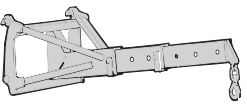
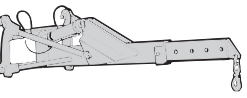
<p>Pallet Fork Tines - Visibility Optimized Lengths: 47" (1200 mm) & 57" (1450 mm) Machines: L50E - L120E Applications: material handling, visibility-optimized for maximum production. Options: standard, heavy & lumber (wider) tines available.</p>	
<p>Fork Frame with Side Shift & Fork Positioner Lengths: 47" (1200 mm) & 57" (1450 mm) Machines: L50E - L120E Applications: handling material where width of the load varies. Options: requires 3rd and 4th function. Tines sold separately.</p>	
<p>Fork Tine Extensions Lengths: 98" (2500 mm) Machines: L50E - L120E Applications: extended reach, intended for lighter materials. Options: for straight & visibility-optimized tines.</p>	
<p>Separate Fork Back Rest Extensions Lengths: 85" (2500 mm) Machines: L50E - L120E Applications: extended back rest for better support of high bundles or stacks of material. Options: sold separately, adjustable on frame.</p>	
<p>Combi-forks with One Piece Clamp Lengths: 47" (1200 mm) & 57" (1450 mm) Machines: L50E - L120E Applications: palletized goods/round woods where load must be secured. Options: heavy duty straight tines recommended. Requires 3rd function.</p>	
<p>Floating Sub-frame & Floating Lumber Tines Lengths: 47" (1200 mm) Machines: L50E - L120E Applications: handling finished wood and picking up bundles or pallets on uneven ground. Options: used with pallet fork frame & combi-fork. Tines sold separately.</p>	
<p>Stone / Block Forks (L90E-L330E) Lengths: 57" (1450 mm) Machines: L90E - L330E Applications: block handling for granite, marble, etc.</p>	
<p>Volvo Attachments - Material Handling Arm Mechanical Material Handling Arm Range: ~10'9" (3290 mm) to ~18'0" (5500 mm) (from front wheel)* Machines: L50E - L120E Applications: material handling, pipe laying, site prep, etc.</p>	
<p>Hydraulic Material Handling Arm Range: ~7'0" (2140 mm) to ~18'0" (5500 mm) (from front wheel)* Machines: L50E - L120E Applications: pipe laying, site prep, etc. Requires 3rd function.</p>	

*) Please refer to attachment catalog for exact dimensions.

OTHER ATTACHMENTS

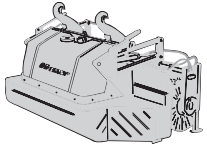
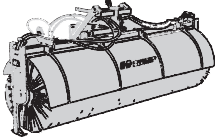
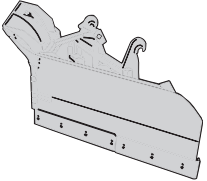
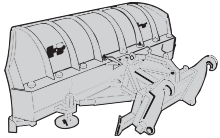
<p>Volvo Attachments - Brooms</p> <p>Street Sweeper Machines: L50E - L120E Attachment sweeps up everything from very fine sand to large piles of trash. Direct water spray retains higher amounts of debris and lowers dust. Without support wheels, quick travel over rough terrain allows for higher productivity.</p>	
<p>Sweeper Roller</p> <p>Machines: L50E - L120E For street cleaning when the debris does not have to be collected. Can be equipped with water tank and spray nozzle bank for dust reduction.</p>	
<p>Volvo Attachments - Snowplows</p> <p>V-plow Snowblade Machines: L50E - L120E Ideal for applications such as gradually opening a snowblocked road or collecting and pushing away snow at junctions, on car parks, etc. Each side is individually adjustable by means of hydraulic cylinders and has mechanical stops at the end positions. Requires 3rd and 4th function and single-acting lift function.</p>	
<p>Diagonal Snowblade Machines: L50E - L120E Ideal for snow clearance on roads, parking lots, etc. Reversible cutting edge divided into sections that fold back when encountering obstacles such as manhole covers. Rubber edges available. Requires 3rd function.</p>	

- **Bale Clamp (L50E - L120E)**
 Clamp for handling of pulp waste paper bales, etc. Strong, slender bale arms ensure secure grip and dense stacking. Built-in pressure reduction and side shift.
- **Rotating Reel Clamp (L50E - L120E)**
 180°-rotating reel clamp for handling of upright or horizontal paper reels with diameters up to 5'9" (1800 mm). Slender arm profile and gentle clamp blades with maintenance-free friction surface facilitate handling. Built-in pressure reduction.
- **Fork Clamp (L50E - L120E)**
 360°-rotating for emptying and/or turning boxes and drums.
- **Drum Rotator (L50E - L120E)**
 360°-rotating units for emptying of liquids and powders in drums.
- **Crate & Pallet Rotator (L50E - L120E)**
 360°-rotating unit for emptying and/or turning of crates and pallets.



Volvo Construction Equipment is different. The company's products are designed, built and supported in a different way. That difference comes from our 170-year engineering heritage. A heritage of thinking first about the people who actually use the machines. About how to make them safer, more comfortable, more productive. About the environment we all share. The result of that thinking is a growing range of machines and a global support network dedicated to helping you do more. People around the world are proud to use Volvo. And we're proud of what makes Volvo different – **More care. Built in.**



All products are not available in all markets. Under our policy of continuous improvement, we reserve the right to change specifications and design without prior notice. The illustrations do not necessarily show the standard version of the machine.

VOLVO

Construction Equipment

Volvo Construction Equipment North America, Inc.

One Volvo Drive, Asheville, NC 28803-3447
www.volvoce.com

Ref. No. 22 A 100 1569
Printed in USA 06/06 – 3,0
Volvo, Asheville

English
USA