

VOLVO WHEEL LOADERS L60E, L70E, L90E, L110E
LONG BOOM



VOLVO

INCREASING DUMP HEIGHT, REDUCING COST PER TON

Today's industry is demanding. From commercial vehicles becoming increasingly tall to growing demands from your customers, Volvo Construction Equipment has a solution to help your bottom line.

Truck Loading Made Easy:

Long booms provide a reliable and low cost means to increase dump height. As truck manufacturers design taller trucks to maximize payload, Volvo Construction Equipment creates a solution specific to this application: to reach this increased payload quickly and efficiently.

Increase Your Inventory:

Stock yards are vital – efficient stockpiling is key and long booms help reach new heights, helping grow your inventory, as well as your business.

Reduce Cost Per Ton:

Saving costs while increasing your profits – long booms help prevent your tires from entering stockpiles – keeping tires away from potential damage, saving tire life and reducing your cost per ton.

The Right Loader For Your Application:

Volvo Construction Equipment now offers long booms on virtually the entire range, from the 11-ton L60E to the 50-ton L330E.





SPECIFICATIONS

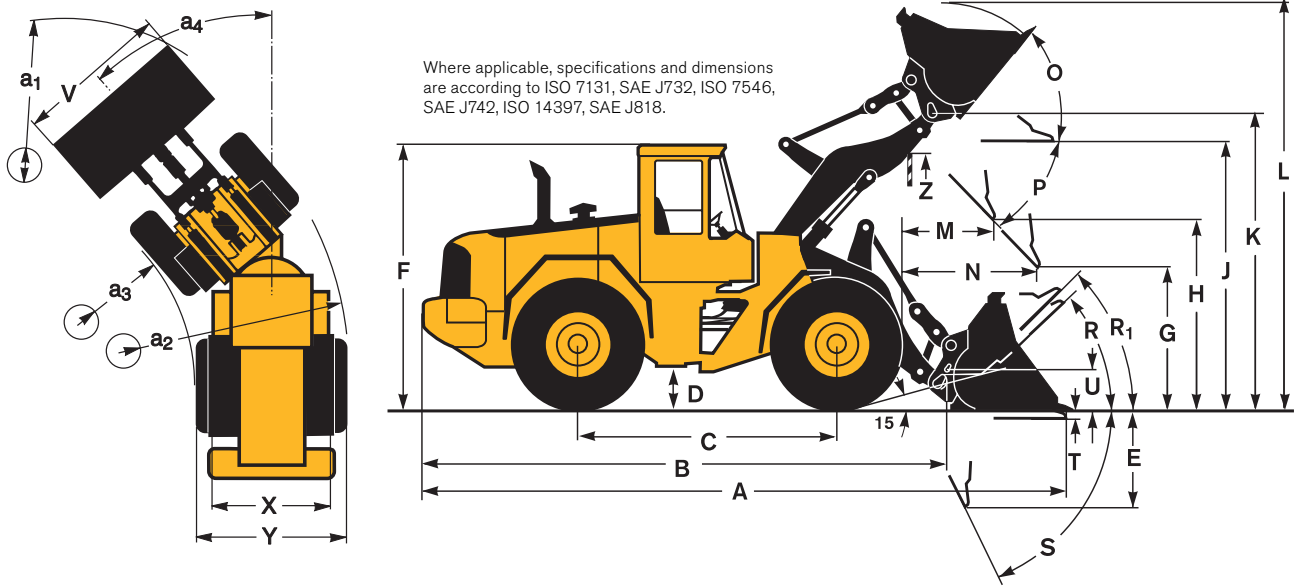









	**L 60E Tires: 20.5 R25 L2		L 70E Tires: 20.5 R25 L2		L 90E Tires: 20.5 R25 L2		L 110E Tires: 23.5 R25 L3	
B	6480 mm	21'3"	6460 mm	21'2"	6450 mm	21'2"	6970 mm	22'10"
C	3000 mm	9'10"	3000 mm	9'10"	3000 mm	9'10"	3200 mm	10'6"
D	450 mm	1'6"	450 mm	1'6"	400 mm	1'4"	440 mm	1'5"
F	3200 mm	10'6"	3260 mm	10'8"	3260 mm	10'8"	3360 mm	11'0"
G	2130 mm	7'0"	2130 mm	7'0"	2130 mm	7'0"	2130 mm	7'0"
J	4100 mm	13'5"	4060 mm	13'4"	4080 mm	13'5"	4230 mm	13'11"
K	4380 mm	14'4"	4340 mm	14'3"	4380 mm	14'4"	4550 mm	14'11"
O	57 °		52 °		57 °		55 °	
P _{max}	44 °		45 °		45 °		46 °	
R	43 °		44 °		46 °		42 °	
R ₁ *	49 °		49 °		52 °		49 °	
S	79 °		73 °		66 °		64 °	
T	130 mm	0'5.1"	109 mm	0'4.3"	117 mm	0'4.6"	90 mm	0'4"
U	530 mm	1'9"	500 mm	1'8"	520 mm	1'8"	610 mm	2'0"
X	1900 mm	6'3"	1930 mm	6'4"	1960 mm	6'5"	2060 mm	6'9"
Y	2440 mm	8'0"	2470 mm	8'1"	2490 mm	8'2"	2680 mm	8'10"
Z	3600 mm	11'10"	3490 mm	11'5"	3620 mm	11'11"	3820 mm	12'6"
a ₂	5340 mm	17'6"	5350 mm	17'7"	5350 mm	17'7"	5730 mm	18'10"
a ₃	2900 mm	9'6"	2890 mm	9'6"	2880 mm	9'5"	3060 mm	10'0"
a ₄	±40 °		±40 °		±40 °		±0 °	

* Carry position SAE
 ** L60E, 17.5 R25 tires not allowed.

Supplemental Operating Data

Tires	L60E Tires 600/65 R25		L70E Tires 600/65 R25		L90E Tires 650/65 R25		L110E Tires 750/65 R25	
	mm	in	mm	in	mm	in	mm	in
Width over tires	+60	+2.4	+60	+2.36	+200	+7.87	+230	+9.1
Ground clearance	-10	-0.39	-20	-0.08	0	0	+30	+1.2
Tipping load, full turn	+150	+330	+130	+286	+360	+794	+360	+790
Operating weight	+240	+530	+240	+529	+690	+1,520	+560	+1,235





L60E

Tires 20.5 R25 L2	GENERAL PURPOSE					FLAT FLOOR	GRADING	LIGHT MATERIAL		STD BOOM
	 Bolt-on edges	 Bolt-on edges	 Bolt-on edges	 Bolt-on edges	 Bolt-on edges	 Bolt-on edges	 Bolt-on edges	 Bolt-on edges	 Bolt-on edges	
Volume, heaped ISO/SAE	m ³ 2,1 yd ³ 2.7	2,1 2.7	1,9 2.5	1,9 2.5	1,7 2.2	2,0 2.6	1,7 2.2	5,0 6.5	3,1 4.1	—
Volume at 110% fill factor	m ³ 2,3 yd ³ 3.0	2,3 3.0	2,1 2.7	2,1 2.7	1,9 2.5	2,2 2.9	1,8 2.3	5,5 7.2	3,4 4.4	—
Static tipping load, straight	kg 6050 lb 13,340	6520 14,380	6070 13,380	6540 14,420	6150 13,560	5880 12,960	5050 11,130	5610 12,370	5650 12,460	+1620 +3,570
at 35° turn	kg 5370 lb 11,840	5820 12,840	5390 11,890	5850 12,900	5480 12,090	5200 11,470	4470 9,860	4930 10,870	5000 11,030	+1490 +3,280
at full turn	kg 5160 lb 11,370	5610 12,370	5190 11,440	5640 12,430	5270 11,620	4990 11,010	4900 9,460	4720 10,400	4800 10,580	+1460 +3,220
Operating load*)	kg 2560 lb 5,630	2780 6,130	2570 5,670	2800 6,160	2610 5,750	2470 5,450	2130 4,690	2340 5,150	2380 5,240	+720 +1,590
Breakout force	kN 89,3 lbf 20,070	96,8 21,760	89,2 20,050	96,8 21,760	94,5 21,240	90,3 20,300	69,3 15,580	62,9 14,140	70,8 15,910	-9,0 -2,020
A	mm 7810 ft in 25'7"	7710 25'3"	7810 25'7"	7710 25'3"	7730 25'4"	7810 25'7"	8130 26'8"	8380 27'5"	8160 26'9"	-520 -1'8"
E	mm 1180 ft in 3'11"	1080 3'7"	1180 3'11"	1080 3'7"	1110 3'8"	1180 3'11"	1440 4'9"	1740 5'9"	1520 5'0"	-40 -1.5"
H**)	mm 3340 ft in 10'11"	3400 11'2"	3340 10'11"	3400 11'2"	3380 11'1"	3350 11'0"	3040 10'0"	2970 9'9"	3110 10'3"	-530 -1'9"
L	mm 5730 ft in 18'9"	5680 18'7"	5630 18'5"	5580 18'3"	5570 18'3"	5670 18'7"	5050 16'6"	6000 19'8"	5800 19'0"	-520 -1'8"
M**))	mm 1030 ft in 3'5"	960 3'2"	1030 3'5"	960 3'2"	980 3'3"	1050 3'6"	1110 3'8"	1490 4'11"	1310 4'4"	+10 +0.4"
N**))	mm 2020 ft in 6'7"	1990 6'6"	2020 6'8"	1990 6'7"	2000 6'7"	1890 6'2"	1920 6'3"	2110 6'11"	2060 6'9"	-440 -1'5"
V	mm 2550 in 100"	2550 100"	2500 98"	2500 98"	2500 98"	2500 98"	2500 98"	2650 104"	2550 100"	—
a ₁ clearance circle	mm 12 080 ft in 39'8"	12 030 39'6"	12 040 39'6"	11 990 39'4"	12 000 39'4"	12 010 39'5"	12 460 40'11"	12 530 41'1"	12 300 40'4"	—
Operating weight	kg 11 810 lb 26,040	11 550 25,470	11 760 25,930	11 500 25,360	11 720 25,850	11 840 26,110	11 720 25,480	12 230 26,970	11 940 26,330	-160 -360

*) Rated at Volvo's recommended maximum utilization for L60E.

Note: This only applies to genuine Volvo attachments.









**) Measured to the tip of the bucket teeth or bolt-on edge. Dump height to bucket edge. Measured at 45° dump angle.

Bucket Selection Chart						
<p>The chosen bucket is determined by the density of the material and the expected bucket fill factor. The actual bucket volume is often larger than the rated capacity, due to the features of the TP Linkage, including an open bucket design, good rollback angles in all positions and good bucket filling performance. The example represents a standard boom configuration. Example: Sand and gravel. Fill factor ~ 105%. Density 2,865 lb/yd³. Result: The 2.2 yd³ bucket carries 2.3 yd³. For optimal stability always consult the bucket selection chart.</p>						
Material	Bucket fill, %	Material density, t/m ³ lb/yd ³	ISO/SAE bucket volume, m ³ yd ³	Actual volume, m ³ yd ³		
Earth/Clay	~ 110		~ 1,60 ~ 2,700	1,7 2.2	~ 1,9 ~ 2.7	
			~ 1,50 ~ 2,530	1,9 2.5	~ 2,1 ~ 2.5	
			~ 1,35 ~ 2,275	2,1 2.7	~ 2,3 ~ 3.0	
Sand/Gravel	~ 105		~ 1,70 ~ 2,865	1,7 2.2	~ 1,8 ~ 2.3	
			~ 1,60 ~ 2,700	1,9 2.5	~ 2,0 ~ 2.5	
			~ 1,45 ~ 2,444	2,1 2.7	~ 2,2 ~ 2.9	
Aggregate	~ 100		~ 1,80 ~ 3,035	1,7 2.2	~ 1,7 ~ 2.2	
			~ 1,70 ~ 2,865	1,9 2.5	~ 1,9 ~ 2.5	
			~ 1,50 ~ 2,530	2,1 2.7	~ 2,1 ~ 2.7	
Rock	≤ 100		~ 1,70 ~ 2,865	1,6 2.1	~ 1,6 ~ 2.1	

The size of rock buckets is optimized for optimal penetration and filling capability rather than the density of the material.

Type of boom	Type of bucket	ISO/SAE Bucket volume	L60E	Material density (t/m ³)						
			0,8 1,0	1,2	1,4	1,6	1,8	2,0		
Standard boom	General purpose	H 1,7 m ³ 2,2 yd ³					1,9 2,5	1,7 2,2		
		P 1,9 m ³ 2,5 yd ³					2,1 2,7	1,9 2,5		
	H 1,9 m ³ 2,5 yd ³				2,1 2,7		1,9 2,5			
Long boom	General purpose	P 2,1 m ³ 2,7 yd ³					2,3 3,0	2,1 2,7		
		H 2,1 m ³ 2,7 yd ³				2,3 3,0	2,1 2,7			
	Flat floor	H 2,0 m ³ 2,6 yd ³					2,0 2,6	1,8 2,3		
Light material	Light material	H 3,1 m ³ 4,1 yd ³		3,1 4,1						
		H 1,7 m ³ 2,2 yd ³				1,9 2,5	1,7 2,2			
		H 3,1 m ³ 4,1 yd ³		3,1 4,1						
Bucket fill			1,350	1,685	2,020	2,360	2,700	3,035	3,370	
110% 105% 100% 95%			Material density (lb/yd ³)							
			H = Hook-on P = Pin-on							





L70E

Tires 20.5 R25 L2	GENERAL PURPOSE						FLAT FLOOR	LIGHT MATERIAL		STD BOOM
										
Volume, heaped ISO/SAE	m ³ 2,3 yd ³ 3.0	m ³ 2,3 yd ³ 3.0	m ³ 2,2 yd ³ 2.9	m ³ 2,2 yd ³ 2.9	m ³ 2,0 yd ³ 2.6	m ³ 2,0 yd ³ 2.6	m ³ 2,2 yd ³ 2.9	m ³ 6,4 yd ³ 4.4	m ³ 3,4 yd ³ 4.4	---
Volume at 110% fill factor	m ³ 2,5 yd ³ 3.3	m ³ 2,5 yd ³ 3.3	m ³ 2,4 yd ³ 3.1	m ³ 2,4 yd ³ 3.1	m ³ 2,2 yd ³ 2.9	m ³ 2,2 yd ³ 2.9	m ³ 2,4 yd ³ 3.1	m ³ 7,0 yd ³ 9.2	m ³ 3,7 yd ³ 4.9	---
Static tipping load, straight	kg 7010 lb 15,460	kg 7500 lb 16,540	kg 7060 lb 15,570	kg 7590 lb 16,730	kg 7120 lb 15,700	kg 7630 lb 16,830	kg 6930 lb 15,280	kg 6190 lb 13,650	kg 6550 lb 14,440	+1680 +3,700
at 35° turn	kg 6210 lb 13,690	kg 6670 lb 14,700	kg 6260 lb 13,800	kg 6750 lb 14,870	kg 6320 lb 13,930	kg 6810 lb 15,010	kg 6130 lb 13,500	kg 5390 lb 11,880	kg 5780 lb 12,740	+1540 +3,400
at full turn	kg 5980 lb 13,190	kg 6430 lb 14,180	kg 6030 lb 13,300	kg 6500 lb 14,340	kg 6090 lb 13,430	kg 6560 lb 14,470	kg 5890 lb 12,990	kg 5150 lb 11,360	kg 5550 lb 12,240	+1500 +3,300
Operating load*)	kg 2950 lb 6,500	kg 3170 lb 6,990	kg 2970 lb 6,550	kg 3200 lb 7,070	kg 3000 lb 6,620	kg 3230 lb 7,130	kg 2900 lb 6,400	kg 2540 lb 5,600	kg 2740 lb 6,030	+740 +1,630
Breakout force	kN 88,5 lbf 19,900	kN 97,0 lbf 21,810	kN 90,3 lbf 20,300	kN 99,1 lbf 22,280	kN 94,6 lbf 21,270	kN 104,5 lbf 23,490	kN 90,7 lbf 20,390	kN 52,3 lbf 11,760	kN 70,4 lbf 15,830	+2,0 +450
A	mm 7850 ft in 25'9"	mm 7750 ft in 25'6"	mm 7820 ft in 25'8"	mm 7720 ft in 25'4"	mm 7760 ft in 25'6"	mm 7660 ft in 25'2"	mm 7810 ft in 25'8"	mm 8690 ft in 28'7"	mm 8140 ft in 26'9"	-470 -1'7"
E	mm 1210 ft in 4'0"	mm 1120 ft in 3'8"	mm 1190 ft in 4'0"	mm 1090 ft in 3'8"	mm 1140 ft in 3'10"	mm 1040 ft in 3'6"	mm 1180 ft in 3'11"	mm 1990 ft in 6'7"	mm 1500 ft in 4'11"	-30 -1.5"
H**)	mm 3240 ft in 10'7"	mm 3310 ft in 10'10"	mm 3260 ft in 10'8"	mm 3330 ft in 10'11"	mm 3300 ft in 10'10"	mm 3370 ft in 11'0"	mm 3260 ft in 10'8"	mm 2640 ft in 8'8"	mm 3020 ft in 9'11"	-490 -1'7"
L	mm 5770 ft in 19'0"	mm 5720 ft in 18'10"	mm 5740 ft in 18'10"	mm 5690 ft in 18'9"	mm 5680 ft in 18'8"	mm 5620 ft in 18'6"	mm 5720 ft in 18'10"	mm 6240 ft in 20'6"	mm 5910 ft in 19'5"	-470 -1'7"
M**)	mm 1120 ft in 3'8"	mm 1040 ft in 3'5"	mm 1100 ft in 3'7"	mm 1020 ft in 3'4"	mm 1060 ft in 3'5"	mm 980 ft in 3'2"	mm 1090 ft in 3'7"	mm 1700 ft in 5'7"	mm 1320 ft in 4'4"	+20 +0.8"
N**)	mm 2050 ft in 6'9"	mm 2010 ft in 6'7"	mm 2040 ft in 6'9"	mm 2000 ft in 6'7"	mm 2020 ft in 6'8"	mm 1980 ft in 6'6"	mm 1910 ft in 6'4"	mm 2120 ft in 7'0"	mm 2080 ft in 6'10"	-400 -1'4"
V	mm 2550 in 100"	mm 2550 in 100"	mm 2550 in 100"	mm 2550 in 100"	mm 2550 in 100"	mm 2550 in 100"	mm 2550 in 100"	mm 2750 in 108"	mm 2650 in 104"	---
a, clearance circle	mm 12 080 ft in 39'9"	mm 12 020 ft in 39'5"	mm 12 060 ft in 39'7"	mm 12 010 ft in 39'5"	mm 12 030 ft in 39'6"	mm 11 980 ft in 39'4"	mm 12 060 ft in 39'7"	mm 12 820 ft in 42'1"	mm 12 380 ft in 40'7"	---
Operating weight	kg 13 430 lb 29,600	kg 13 230 lb 29,160	kg 13 390 lb 29,510	kg 13 190 lb 29,060	kg 13 350 lb 29,420	kg 13 140 lb 28,960	kg 13 520 lb 29,800	kg 14 100 lb 31,070	kg 13 630 lb 30,040	-250 -540

*) Rated at Volvo's recommended maximum utilization for L70E.

Note: This only applies to genuine Volvo attachments.







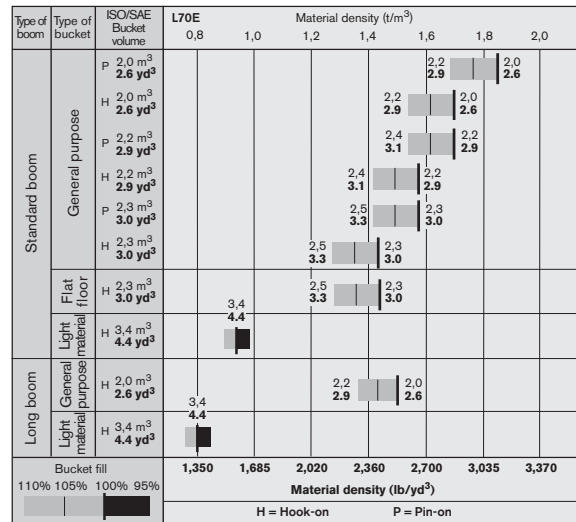

**) Measured to the tip of the bucket teeth or bolt-on edge. Dump height to bucket edge. Measured at 45° dump angle.

Bucket Selection Chart						
The chosen bucket is determined by the density of the material and the expected bucket fill factor. The actual bucket volume is often larger than the rated capacity, due to the features of the TP Linkage, including an open bucket design, good rollback angles in all positions and good bucket filling performance. The example represents a standard boom configuration.						
Example: Sand and gravel. Fill factor ~ 105%. Density 2,865 lb/yd ³ . Result: The 2.6 yd ³ bucket carries 2.7 yd ³ . For optimal stability always consult the bucket selection chart.						
Material	Bucket fill, %	Material density, t/m ³ lb/yd ³	ISO/SAE bucket volume, m ³ yd ³	Actual volume, m ³ yd ³		
Earth/Clay	~ 110		~ 1,65 ~ 2,780	2,0 2.6	~ 2,2 ~ 2.9	
			~ 1,55 ~ 2,610	2,2 2.9	~ 2,4 ~ 3.1	
			~ 1,40 ~ 2,865	2,3 3.0	~ 2,5 ~ 3.3	
Sand/Gravel	~ 105		~ 1,70 ~ 2,865	2,0 2.6	~ 2,1 ~ 2.7	
			~ 1,60 ~ 2,700	2,2 2.9	~ 2,3 ~ 3.0	
			~ 1,45 ~ 2,444	2,3 3.0	~ 2,4 ~ 3.1	
Aggregate	~ 100		~ 1,80 ~ 3,035	2,0 2.6	~ 2,0 ~ 2.6	
			~ 1,70 ~ 2,865	2,2 2.9	~ 2,2 ~ 2.9	
			~ 1,55 ~ 2,613	2,3 3.0	~ 2,3 ~ 3.0	
Rock	≤ 100		~ 1,70 ~ 2,865	1,8 2.3	~ 1,8 ~ 2.3	

The size of rock buckets is optimized for optimal penetration and filling capability rather than the density of the material.



L90E

Tires 20.5 R25 L2	GENERAL PURPOSE					FLAT FLOOR		LIGHT MATERIAL		STD BOOM
										
	Bolt-on edges	Bolt-on edges	Bolt-on edges	Bolt-on edges	Bolt-on edges	Bolt-on edges	Bolt-on edges	Bolt-on edges	Bolt-on edges	
Volume, heaped ISO/SAE	m ³ 2,7 3.5	2,7 3.5	2,5 3.3	2,5 3.3	2,3 3.0	2,6 3.4	2,6 3.4	7,0 9.2	4,1 5.4	—
Volume at 110% fill factor	m ³ 3,0 3.9	3,0 3.9	2,8 3.7	2,8 3.7	2,5 3.3	2,9 3.8	2,9 3.8	7,7 10.1	4,5 5.9	—
Static tipping load, straight	kg 9590 21,140	8920 19,670	9420 20,770	9010 19,860	9190 20,260	9490 20,920	8820 19,440	8330 18,360	8620 19,000	+1640 +3,620
at 35° turn	kg 8470 18,670	7840 17,280	8320 18,340	7930 17,480	8100 17,850	8380 18,470	7760 17,110	7250 15,980	7560 16,660	+1500 +3,310
at full turn	kg 8150 17,960	7530 16,600	8000 17,640	7620 16,850	7790 17,170	8070 17,790	7460 16,440	6940 15,300	7250 15,980	+1450 +3,200
Operating load*)	kg 3940 8,680	3640 8,020	3860 8,520	3680 8,120	3760 8,300	3900 8,600	3600 7,950	3350 7,390	3500 7,720	+700 +1,540
Breakout force	kN 115,6 25,990	107,4 24,150	120,3 27,050	111,5 25,070	116,1 26,100	120,9 27,180	111,9 25,160	75,4 16,950	86,9 19,540	-2,0 -4,50
A	mm 7880 25'10"	7970 26'2"	7820 25'8"	7910 25'11"	7850 25'9"	7820 25'8"	7910 25'11"	8600 28'2"	8300 27'3"	-410 -1'4"
E	mm 1200 4'0"	1300 4'3"	1150 3'10"	1240 4'1"	1180 3'11"	1150 3'10"	1230 4'1"	1850 6'1"	1580 5'3"	+10 +0,2"
H**)	mm 3230 10'8"	3170 10'5"	3270 10'9"	3200 10'6"	3240 10'8"	3260 10'9"	3200 10'6"	2760 9'1"	2960 9'9"	-420 -1'5"
L	mm 5840 19'2"	5900 19'4"	5790 19'0"	5840 19'2"	5790 19'0"	5800 19'1"	5860 19'3"	6170 20'3"	5970 19'8"	-420 -1'5"
M**)	mm 1080 3'6"	1160 3'10"	1040 3'5"	1120 3'8"	1080 3'6"	1040 3'5"	1100 3'7"	1630 5'4"	1420 4'8"	+50 +0' 2"
N**)	mm 2050 6'9"	2090 6'10"	2040 6'8"	2070 6'9"	2060 6'9"	1900 6'3"	1930 6'4"	2090 6'10"	2100 6'11"	-360 -1'2"
V	mm 2750 108"	2750 108"	2650 104"	2650 104"	2650 104"	2650 104"	2650 104"	3000 118"	2750 108"	—
a ₁ clearance circle	mm 12 260 40'3"	12 320 40'5"	12 150 39'10"	12 200 40'0"	12 170 39'11"	12 150 40'0"	12 200 42'4"	12 900 41'1"	12 510 41'1"	—
Operating weight	kg 15 410 33,970	15 760 34,740	15 370 33,890	15 630 34,450	15 590 34,370	15 460 34,090	15 600 34,390	16 310 35,960	15 880 35,000	-250 -540

*) Rated at Volvo's recommended maximum utilization for L90E.

Note: This only applies to genuine Volvo attachments.







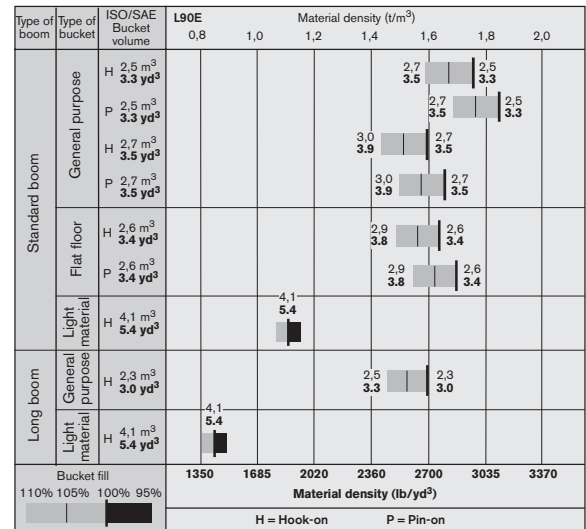

**) Measured to the tip of the bucket teeth or bolt-on edge. Dump height to bucket edge. Measured at 45° dump angle.

Bucket Selection Chart					
The chosen bucket is determined by the density of the material and the expected bucket fill factor. The actual bucket volume is often larger than the rated capacity, due to the features of the TP Linkage, including an open bucket design, good rollback angles in all positions and good bucket filling performance. The example represents a standard boom configuration.					
Example: Sand and gravel. Fill factor ~ 105%. Density 2,780 lb/yd ³ . Result: The 3.5 yd ³ bucket carries 3.7 yd ³ . For optimal stability always consult the bucket selection chart.					
Material	Bucket fill, %	Material density, t/m ³ / lb/yd ³	ISO/SAE bucket volume, m ³ / yd ³	Actual volume, m ³ / yd ³	
Earth/Clay	~ 110	~ 1,80 ~ 3,035	2,5 3.3	~ 2,7	~ 3,5
			2,6 3.4	~ 2,9	~ 3,8
Sand/Gravel	~ 105	~ 1,80 ~ 3,035	2,5 3.3	~ 2,6	~ 3,4
			2,6 3.4	~ 2,7	~ 3,5
Aggregate	~ 100	~ 1,80 ~ 3,035	2,5 3.3	~ 2,5	~ 3,3
			2,6 3.4	~ 2,6	~ 3,4
Rock	≤ 100	~ 1,80 ~ 3,035	2,2 2.9	~ 2,2	~ 2,9
			2,7 3.5	~ 2,7	~ 3,5

The size of rock buckets is optimized for optimal penetration and filling capability rather than the density of the material.



L110E

Tires 23.5 R25 L3	GENERAL PURPOSE							LIGHT MATERIAL		STD BOOM
										
	Bolt-on edges	Bolt-on edges	Teeth & Segments	Teeth & Segments	Teeth & Segments	Teeth & Segments	Teeth & Segments	Bolt-on edges	Bolt-on edges	
Volume, heaped ISO/SAE	m ³ 3,4 yd ³ 4.4	m ³ 3,1 yd ³ 4.1	m ³ 3,1 yd ³ 4.1	m ³ 3,1 yd ³ 4.1	m ³ 3,1 yd ³ 4.1	m ³ 3,1 yd ³ 4.1	m ³ 2,9 yd ³ 3.8	m ³ 9,5 yd ³ 12.4	m ³ 5,5 yd ³ 7.2	—
Volume at 110% fill factor	m ³ 3,7 yd ³ 4.8	m ³ 3,4 yd ³ 4.5	m ³ 3,4 yd ³ 4.5	m ³ 3,4 yd ³ 4.5	m ³ 3,4 yd ³ 4.5	m ³ 3,4 yd ³ 4.5	m ³ 3,2 yd ³ 4.2	m ³ 10,5 yd ³ 13.7	m ³ 6,1 yd ³ 8.0	—
Static tipping load, straight	kg 10 300 lb 22,700	kg 10 440 lb 23,020	kg 9690 lb 21,360	kg 10 440 lb 23,020	kg 9650 lb 21,270	kg 9700 lb 21,390	kg 10 010 lb 22,070	kg 8950 lb 19,730	kg 8860 lb 19,530	+2540 +5,600
at 35° turn	kg 9110 lb 20,090	kg 9250 lb 20,400	kg 8550 lb 18,850	kg 9260 lb 20,420	kg 8520 lb 18,790	kg 8560 lb 18,880	kg 8820 lb 19,450	kg 7800 lb 17,200	kg 7750 lb 17,090	+2320 +5,110
at full turn	kg 8760 lb 19,320	kg 8890 lb 20,480	kg 8210 lb 18,100	kg 8900 lb 19,620	kg 8180 lb 18,040	kg 8220 lb 18,120	kg 8460 lb 18,650	kg 7450 lb 16,430	kg 7410 lb 16,340	+2260 +4,980
Operating load*)	kg 4120 lb 9,080	kg 4180 lb 9,210	kg 3860 lb 8,510	kg 4190 lb 9,220	kg 3850 lb 8,480	kg 3870 lb 8,530	kg 3980 lb 8,770	kg 3500 lb 7,720	kg 3490 lb 7,680	+1060 +2,340
Breakout force	kN 163,3 lbf 36,720	kN 170,5 lbf 38,330	kN 158,6 lbf 35,660	kN 176,3 lbf 39,640	kN 163,8 lbf 36,830	kN 163,7 lbf 36,800	kN 147,2 lbf 33,100	kN 111,3 lbf 25,020	kN 124,7 lbf 28,040	-20 -4,500
A	mm 8520 ft in 27'11"	mm 8450 ft in 27'9"	mm 8520 ft in 27'11"	mm 8360 ft in 27'5"	mm 8560 ft in 28'1"	mm 8500 ft in 27'11"	mm 8520 ft in 27'11"	mm 9290 ft in 30'6"	mm 8990 ft in 29'6"	-510 -1'8"
E	mm 1260 ft in 4'2"	mm 1200 ft in 3'11"	mm 1300 ft in 4'3"	mm 1150 ft in 3'9"	mm 1300 ft in 4'3"	mm 1250 ft in 4'1"	mm 1310 ft in 4'4"	mm 1970 ft in 6'6"	mm 1710 ft in 5'7"	+2 +0.01"
H**)	mm 3310 ft in 10'10"	mm 3360 ft in 11'0"	mm 3330 ft in 10'11"	mm 3400 ft in 11'2"	mm 3290 ft in 10'10"	mm 3320 ft in 10'11"	mm 3110 ft in 10'2"	mm 2800 ft in 9'2"	mm 2930 ft in 9'7"	-520 -1'8"
L	mm 6140 ft in 20'2"	mm 6070 ft in 19'11"	mm 6130 ft in 20'1"	mm 6010 ft in 19'2"	mm 6130 ft in 20'1"	mm 6080 ft in 19'11"	mm 6030 ft in 19'9"	mm 6520 ft in 21'5"	mm 6350 ft in 20'10"	-520 -1'8"
M**)	mm 1170 ft in 3'10"	mm 1120 ft in 3'8"	mm 1160 ft in 3'10"	mm 1080 ft in 3'7"	mm 1200 ft in 3'11"	mm 1170 ft in 3'10"	mm 1240 ft in 4'1"	mm 1700 ft in 5'7"	mm 1490 ft in 4'11"	+35 +0'1.4"
N**)	mm 2160 ft in 7'1"	mm 2130 ft in 7'0"	mm 2170 ft in 7'1"	mm 2120 ft in 6'11"	mm 2180 ft in 7'2"	mm 2160 ft in 7'1"	mm 2340 ft in 7'8"	mm 2230 ft in 7'4"	mm 2220 ft in 7'3"	-430 -1'5"
V***)	mm 2880 in 113"	mm 2880 in 113"	mm 2880 in 113"	mm 3000 in 118"	mm 3000 in 118"	mm 2880 in 113"	mm 2880 in 113"	mm 3400 in 134"	mm 3000 in 118"	—
a ₁ clearance circle	mm 13 070 ft in 41'8"	mm 13 030 ft in 42'9"	mm 13 100 ft in 41'7"	mm 13 110 ft in 41'8"	mm 13 170 ft in 42'7"	mm 12 990 ft in 42'7"	mm 13 070 ft in 42'11"	mm 14 050 ft in 46'1"	mm 13 510 ft in 44'4"	—
Operating weight	kg 18 540 lb 40,830	kg 18 460 lb 40,710	kg 18 720 lb 41,270	kg 18 430 lb 40,640	kg 18 720 lb 41,280	kg 18 690 lb 41,210	kg 18 850 lb 41,560	kg 19 350 lb 42,660	kg 19 130 lb 42,180	-320 -705

*) Rated at Volvo's recommended maximum utilization for L110E.

Note: This only applies to genuine Volvo attachments.

***) Measured to the tip of the bucket teeth or bolt-on edge. Dump height to bucket edge. Measured at 45° dump angle. (Spade nose buckets at 42°.)

****) 113" wide buckets not recommended for 750/65 R25 tires.

Bucket Selection Chart

The chosen bucket is determined by the density of the material and the expected bucket fill factor. The actual bucket volume is often larger than the rated capacity, due to the features of the TP Linkage, including an open bucket design, good rollback angles in all positions and good bucket filling performance. The example represents a standard boom configuration.

Example: Sand and gravel. Fill factor ~ 105%. Density 2,780 lb/yd³. Result: The 4.1 yd³ bucket carries 4.3 yd³. For optimal stability always consult the bucket selection chart.

Material	Bucket fill, %	Material density,		ISO/SAE bucket volume,		Actual volume,	
		t/m ³	lb/yd ³	m ³	yd ³	m ³	yd ³
Earth/Clay	~ 110	~ 1,80	~ 3,035	2,9	3.8	~ 3,2	~ 4.2
		~ 1,70	~ 2,865	3,1	4.1	~ 3,4	~ 4.5
		~ 1,50	~ 2,530	3,4	4.5	~ 3,7	~ 4.8
Sand/Gravel	~ 105	~ 1,65	~ 2,780	2,9	3.8	~ 3,0	~ 3.9
		~ 1,65	~ 2,780	3,1	4.1	~ 3,3	~ 4.3
		~ 1,50	~ 2,530	3,4	4.5	~ 3,6	~ 4.7
Aggregate	~ 100	~ 1,90	~ 3,200	2,9	3.8	~ 2,9	~ 3.8
		~ 1,70	~ 2,865	3,1	4.1	~ 3,1	~ 4.1
		~ 1,50	~ 2,530	3,4	4.5	~ 3,4	~ 4.4
Rock	≤ 100	~ 1,80	~ 3,035	2,7	3.5	~ 2,7	~ 3.5

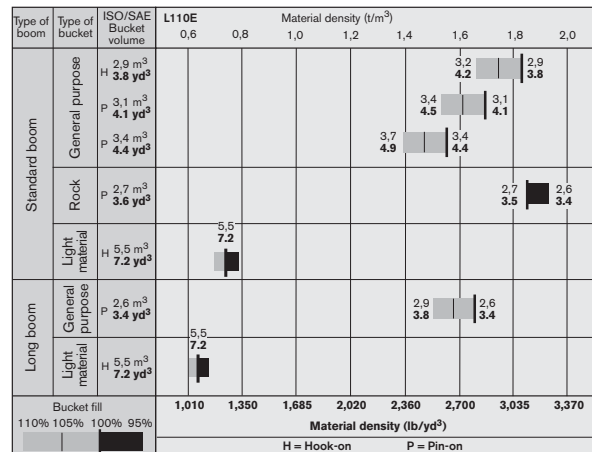

The size of rock buckets is optimized for optimal penetration and filling capability rather than the density of the material.





Volvo Construction Equipment is different. It's designed, built and supported in a different way. That difference comes from our 170-year engineering heritage. A heritage of thinking first about the people who actually use the machines. About how to help them be safer, more comfortable, more productive. About the environment we all share. The result of that thinking is a growing range of machines and a global support network dedicated to helping you do more. People around the world are proud to use Volvo. And we're proud of what makes Volvo different – **More care. Built in.**



All products are not available in all markets. Under our policy of continuous improvement, we reserve the right to change specifications and design without prior notice. The illustrations do not necessarily show the standard version of the machine.

VOLVO

Construction Equipment

Volvo Construction Equipment North America, Inc.

One Volvo Drive, Asheville, NC 28803-3447

www.volvoce.com

Ref. No. 22 A 100 1572
Printed in USA 04/06 - 3,0
Volvo, Asheville

English
USA