

ATTACHMENTS

FOR VOLVO BM LOADERS

4600

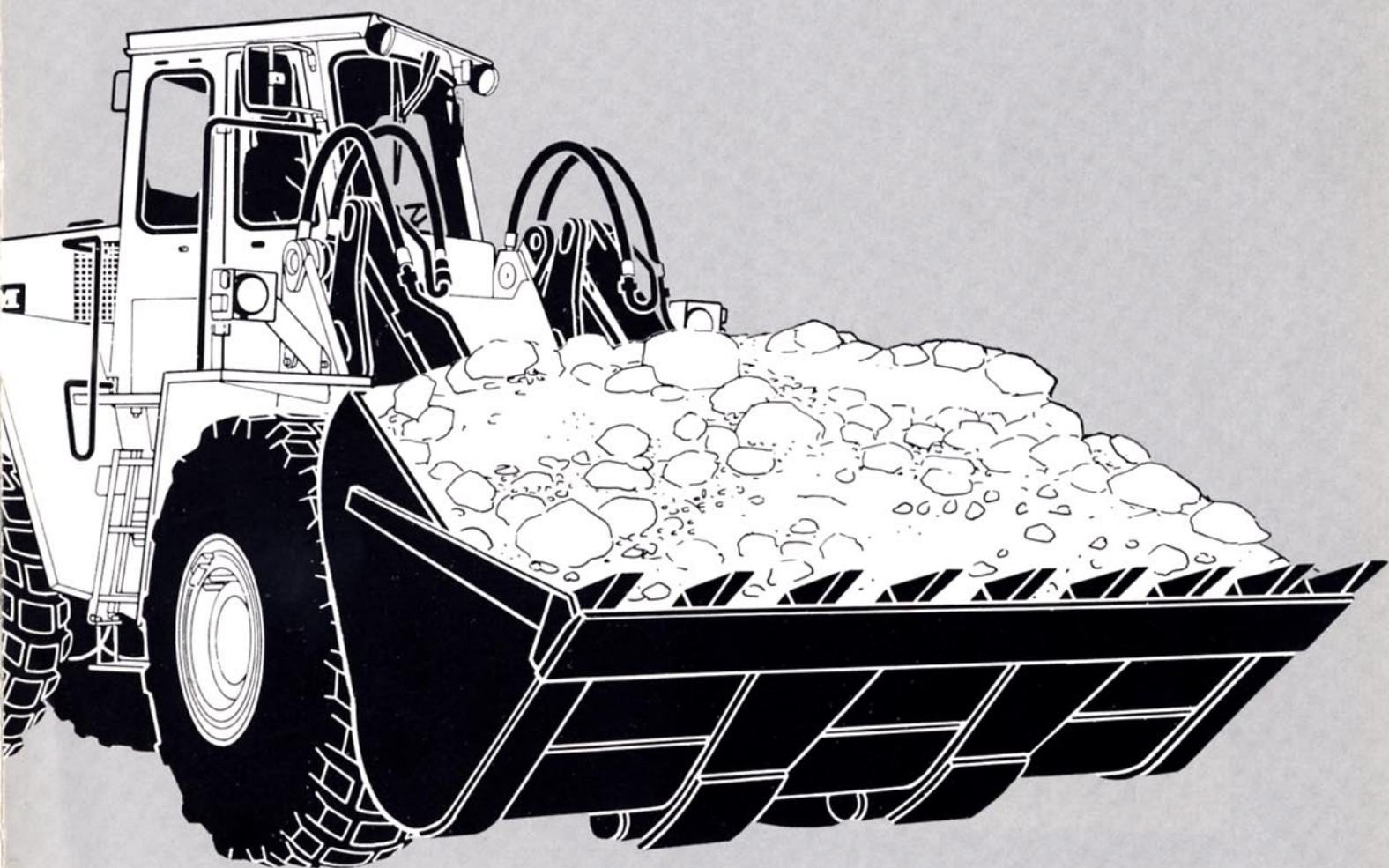

Genuine Volvo BM attachments give optimum overall economy

A loader is only as efficient as its attachment!

You should therefore make the same quality and function demands on your attachments as you do on your loader. Attachments marketed by Volvo BM meet the most stringent requirements imaginable and are specially designed for use with Volvo BM loaders. The product plate which is found on all genuine Volvo BM attachments is your guarantee that the attachment has been tried, tested and approved by Volvo BM. That's comforting to know!

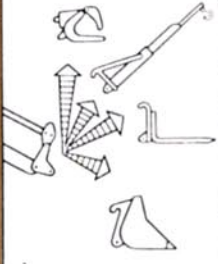
	ARTIKEL/PART NR.	<input type="text"/>
	TILLV./MANUF. NR.	<input type="text"/>
	VIKT/WEIGHT	<input type="text"/> kg
	MAX TRYCK/PRESSURE	<input type="text"/> MPa
	MAX. LAST/SAFE LM	<input type="text"/> kg
	WORKING LOAD LM	<input type="text"/> kg
	VOLYM/VOLUME/AREA	<input type="text"/> m ³ <input type="text"/> m ²
VOLVO BM SWEDEN		

The product plate gives the attachment's part number, manufacturing number, weight, size and maximum load in combination with the machine in question. The plate marks the attachment as a genuine Volvo BM product and serves as an identification document.

STRAIGHT LIP WITHOUT TEETH

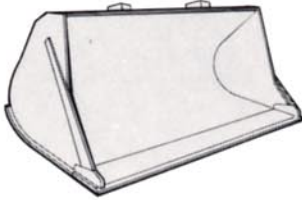

Used for stockpiling and loading material which can be broken loose from the bank with relative ease. Bucket capacity is chosen in relation to material density.

Sand, gravel, soil — 1800 kg/m³ (3000 lb/yd³) °
 Sand, soil — 1600 kg/m³ (2700 lb/yd³) °°

Order No.	Capacity SAE m ³ /yd ³	Mounting R* D**	Width mm	Depth mm	Height mm	No. of teeth	Weight kg
98933	3.8/5	R	3200	1420	1630	—	1800
99026	3.8/5	D	3200	1515	1640	—	1880
99203	4.2/5.5	D	3200	1515	1770	—	1955

STRAIGHT LIP WITH TEETH

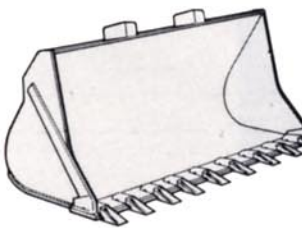

Used for loading material which requires high penetration and breakout forces.

Sand, gravel — 1800 kg/m³ (3000 lb/yd³) °
 Sand, soil etc. 1600 kg/m³ (2700 lb/yd³) °°
 Soil, clay etc. — 1500 kg/m³ (2500 lb/yd³) °°°

98936	3.8/5	R	3200	1600	1630	9	2010
98932	3.8/5	D	3200	1700	1620	9	2040
99202	4.2/5.5	D	3200	1700	1750	9	2115
99030	4.5/6	R	3200	1780	1735	9	2110
99029	4.5/6	D	3200	1900	1750	9	2170

TRUNCATED VEE LIP WITHOUT TEETH

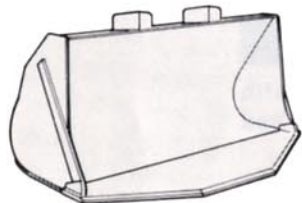

Used for loading material which requires high penetration and breakout forces.

For gravel and finely-blasted rubble — 1800 kg/m³ (3000 lb/yd³)

99023	3.8/5	D	3200	1720	1620	—	1750
-------	-------	---	------	------	------	---	------

TRUNCATED VEE LIP WITH TEETH

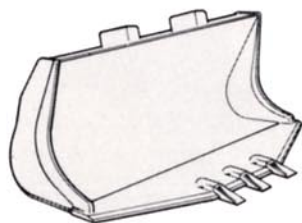

Used for loading material which requires very high penetration and breakout forces. The bucket has low-cut sides to facilitate easy penetration into the material.

For hard gravel and blast rubble — 1800 kg/m³ (3000 lb/yd³)

98934	3.8/5	D	3200	1830	1570	3	2000
-------	-------	---	------	------	------	---	------

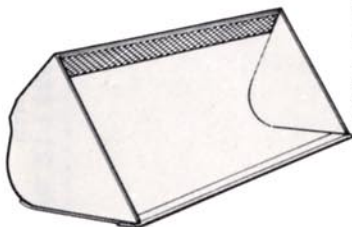

LIGHT MATERIALS BUCKET



Designed for handling material of low density.

For wood chips, coal, snow etc. — 800 kg/m³ (1350 lb/yd³).

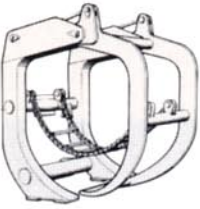
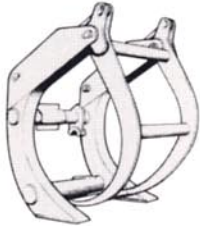
99172	7/9.2	R	3200	2000	1900	—	2170
-------	-------	---	------	------	------	---	------

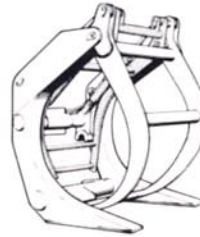
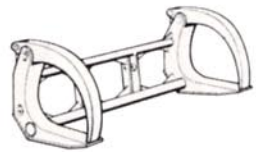
	Order No.	Area m ² /ft ²	Mounting R* D**	Width mm	Height mm	Depth mm	Weight kg
<p>UNLOADING GRAPPLE PULPWOOD</p>  <p>For unloading pulpwood from a truck and placing it on a stack. The grapple is distinguished by short tines. Due to the short length of the tines, the grapple does not have to be equipped with a kick-out. The grapple can also be used for sorting.</p> <p>The attachment requires that the machine must be equipped with hydraulic snap-on coupling.</p>	99133	4,1/43	R	1600	2800	2700	1820
<p>UNLOADING GRAPPLE TIMBER</p>  <p>For unloading timber from a truck and placing it on a stack. The grapple is distinguished by short tines. Due to the short length of the tines, the grapple does not have to be equipped with a kick-out. The grapple can also be used for sorting.</p> <p>The attachment requires that the machine must be equipped with hydraulic snap-on coupling.</p>	99104	2.8/30	R	1780	2500	2500	1500
<p>SORTING GRAPPLE</p>  <p>For feeding sorting plants from stacks and further transport to timber bins.</p> <p>Relatively long tines in order to reach into compartments. The grapple is not ideally suited for unloading trucks, due to its relatively long tines. Its area is adapted for 4.5 m (15 ft) lengths. The sorting grapple can be equipped with combined hydraulic heel/kick-out.</p> <p>The attachment requires that the machine must be equipped with hydraulic snap-on coupling.</p>	99103	2.8/30	R	1780	2500	2450	1700
<p>HEEL/KICK-OUT</p>  <p>The heel/kick-out is to be mounted afterwards.</p> <p>The hydraulic heel/kick-out requires an additional hydraulic function.</p>	99102	—	—	—	—	—	230
<p>TROPICAL GRAPPLE</p>  <p>For handling timber mainly of tropical species, large diameter and high density. The grapple is distinguished by its large width, and two separate clamping arms in order to hold large, heavy stems securely. The attachment requires an extra hydraulic function.</p>	99205	1.4/15	D	3000	1730	1900	1350

R* = Snap-on coupling D** = Bolt-on attachment

SPILL PLATE



Prevents material from spilling over back edge of bucket on backward tilting. Can be mounted on bucket supplied with tilting cylinder protection.

The spill plate with mounting parts is supplied for mounting later only.

Order No.

99175

Width mm

1850

Height mm

350

Depth mm

—

Weight kg

70

HYDRAULIC BRACKET

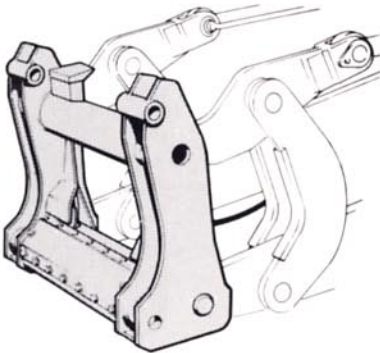

The attachment bracket requires an extra hydraulic function.

99032

—

—

—

300

LOG PUSHER

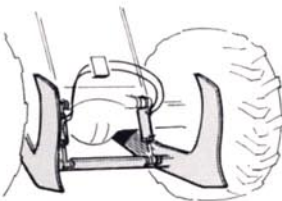

Recommended for all roundwood handling, this attachment is useful in maintaining high stacks and in clearing a path in front of the loader.

The log pusher requires an extra hydraulic function.

99292

1500

1500

—

700



The Volvo BM 4600 is a capacity loader which combines high productivity with optimum overall economy. It is rugged, reliable, extremely comfortable and dependable in all situations.

VOLVO BM

VOLVO BM AB ESKILSTUNA SWEDEN

Under our policy of continual product improvement, we reserve the right to change specifications or design without prior notice. Illustrations do not necessarily show the machine in the standard version.

Ref.No. 21 1 669 1514
ENGELSKA

Production group for basic printed matter Volvo BM
Photo: Foto Consult