

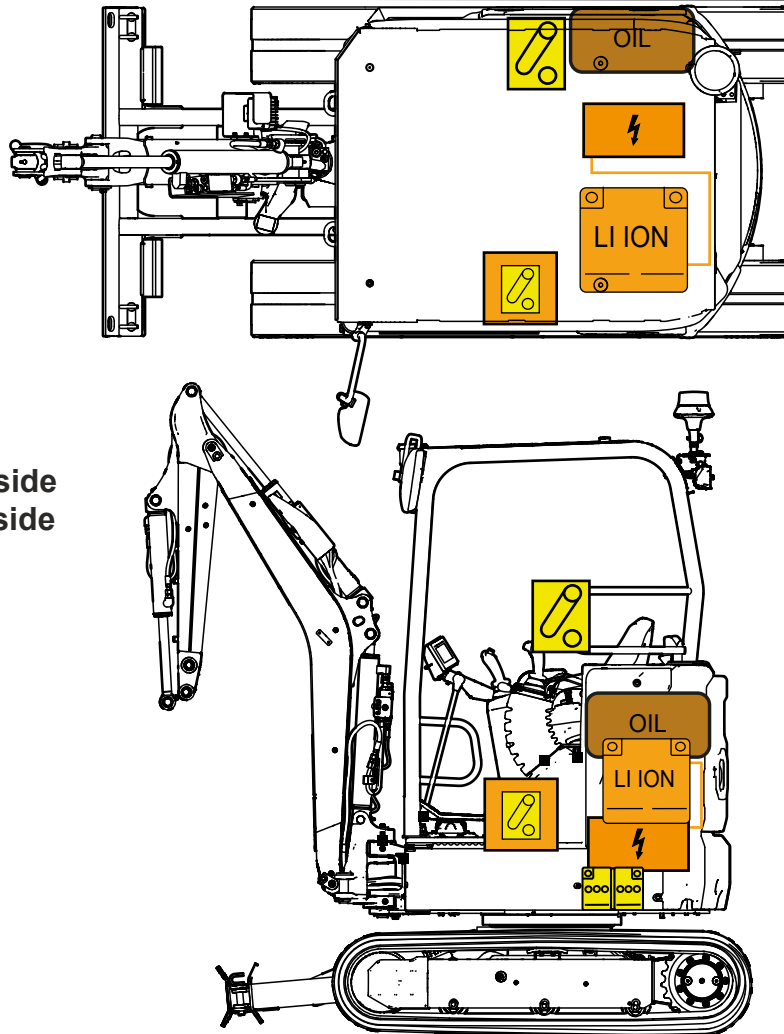

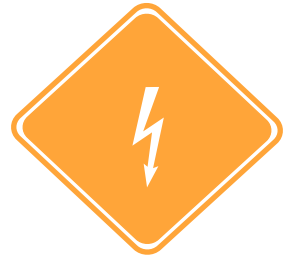





# VOLVO Crawler Excavator

## ECR18 Electric

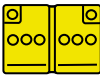

- <2 ton machine
- 4 Li-Ion batteries
- 1 door left side
- 2 window to open front side
- 1 window to open right side
- 1 seat

 48V lithium-ion battery pack	 Low voltage device that disconnects the high voltage	 Battery, low-voltage	 Device to shut down power in a vehicle	 High voltage component	 High voltage power cable
 Tank content oil					

# 1. Identification/recognition

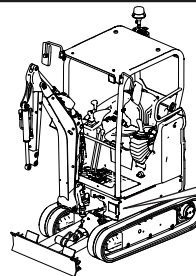
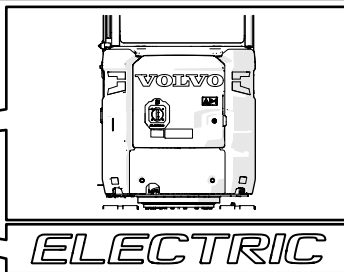
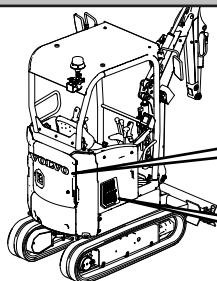

Volvo Construction Equipment	
Volvo Compact Equipment S.A.S. Rue Pierre Pingon, BP119, 01303 Belley, France.	
Type/Model	EXCAVATOR/JECR18E
Product Name	ECR18 ELECTRIC
Product Identification Number	*VCECR18E*****
Machine mass kg	
Nominal power kW	
Manufacturing year	
Made in	Assembled in
<b>VOLVO</b>	

# 2. Immobilisation/stabilization/lifting

Always approach the machine from the sides to stay out of the potential travel path. It may be difficult to determine, if the machine is running due to lack of noise.

immobilisation: Armrest (control lockout lever) in upper position  
 stabilisation: working attachment and dozer blade on ground  
 lifting: at marked lifting points

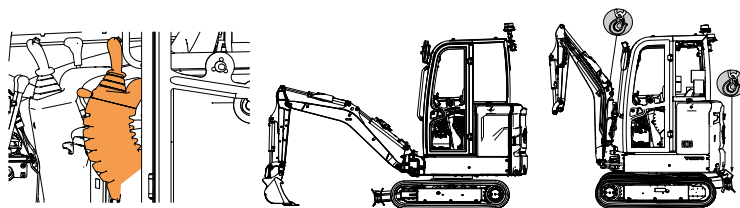

# 3. Disable direct hazardous/safety regulations

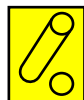

**1** Turn off the ignition and remove the key.

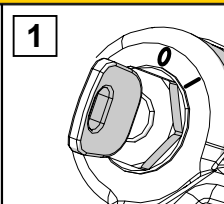

**2** Turn the battery disconnect switch in the cabin to the off position

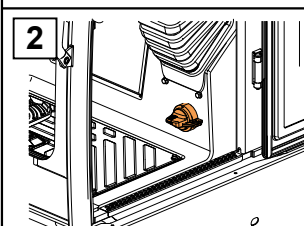

**⚠** If the machine is connected to a standard charging connector (Type 1 or Type 2)

- 1** Disconnect the charging cable from the power grid.
- 2** Interrupt the charging\* by turn on the ignition and press the charging switch (1).
- 3** Disconnect the charging connector from the socket.

\* The charging process can be forced to stop by opening the rear hood.

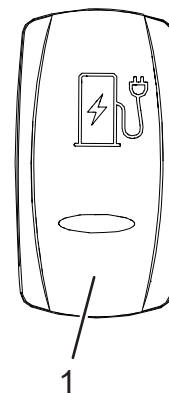

**⚠** If the machine is connected to a fast charging connector

- 1** Interrupt the charging\* by turn on the ignition and press the charging switch (1) or press the stop button on the off-board charger.
- 2** Disconnect the charging connector from the socket.

\* The charging process can be forced to stop by opening the rear hood.

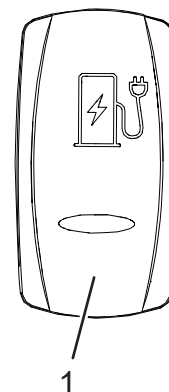

## 4. Stored energy / liquid / gases / solid

48V lithium-ion  
battery pack



25 L

OIL

## 5. In case of fire



Use large sustained volume of water for lithium-ion battery related fire.



Class ABC fire extinguisher can be used if other materials are involved.



In case of thermal runaway, hydrogen fluoride can be released by the lithium-ion batteries.

## 6. In case of water submersion



The damage level of a submerged machine may not be visible.

Submersion in water can damage 12 V and 48 V components.

Handling a submerged machine without appropriate Personal Protective Equipment (PPE) will result in serious injury or death from electric shock.

Avoid any contact with 48 V cables and electric components.

If possible disable direct hazards (See chapter 3).

## 7. Towing / transportation / storage



If the traction batteries are damaged, there can be a risk of thermal or chemical reaction.

The electric machine met with an accident must be parked in a suitable place by maintaining a safe distance from other machines, vehicles, buildings and combustible objects.

Risk of late fire can happen, after the fire suppression or in case the lithium-ion batteries are damaged.



Observe the machine for a minimum period of 48 hours using a thermal infrared camera.

## 8. Important additional information



Do not cut any orange cables.

Do not touch any high voltage cables and electric components.

Do not perform any operation on a damaged machine without appropriate Personal Protective Equipment (PPE).

Identification number

53854334

Version number

01/2023

Page number

3