

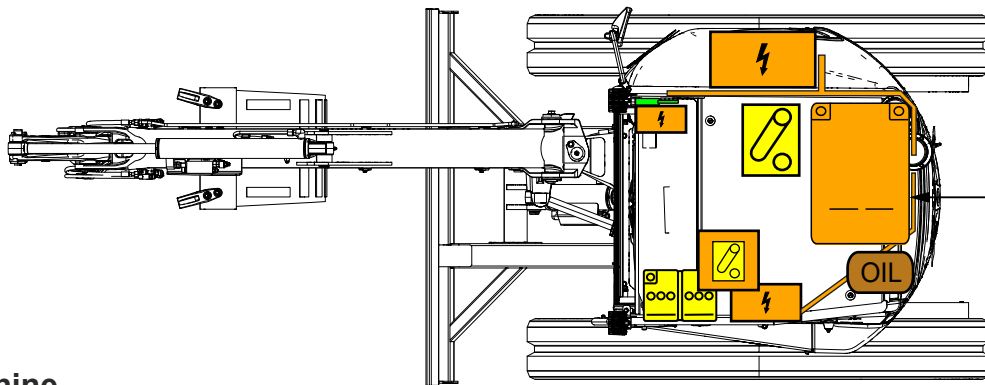

VOLVO Crawler Excavator

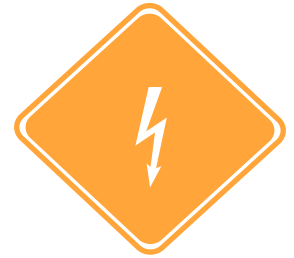





ECR25 ELECTRIC

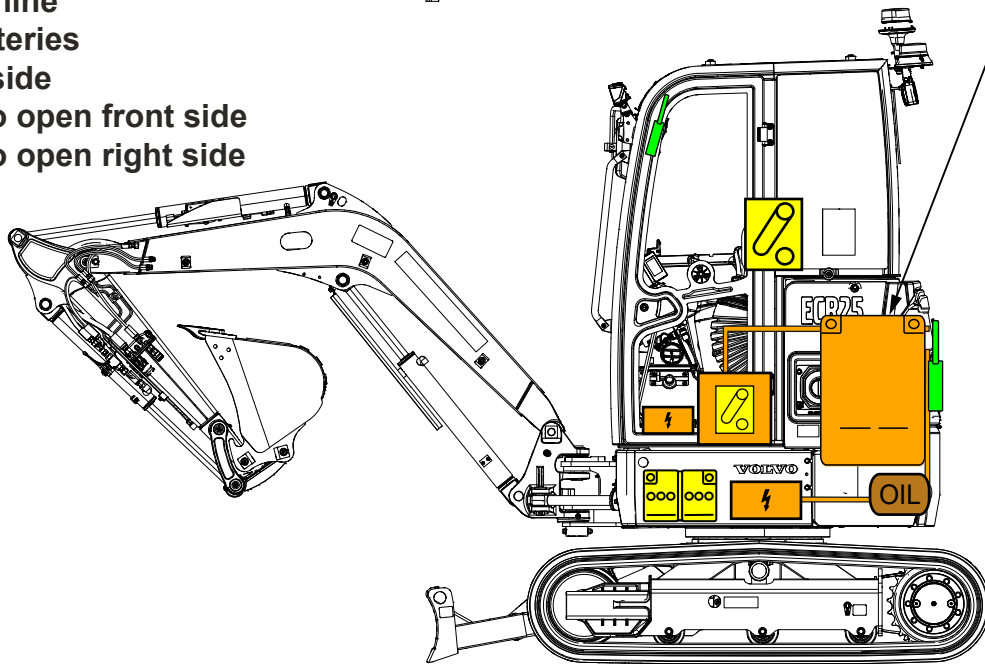

Li-Ion
48 V

- ≤3 ton machine
- 3 Li-Ion batteries
- 1 door left side
- 2 window to open front side
- 1 window to open right side
- 1 seat

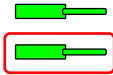

 48 V lithium-ion battery	 Low voltage device that disconnects the high voltage	 Low voltage battery	 Oil tank	 High voltage cable	 Gas strut, pre-loaded gas cylinder
 Ignition key	 High voltage component				

	Identification number	Version number	Page number
	53101813	01/2022	1

1. Identification/recognition

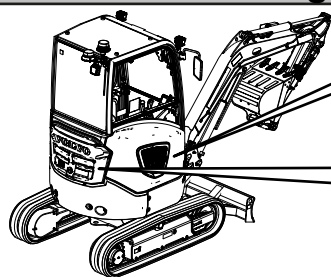

ELECTRIC

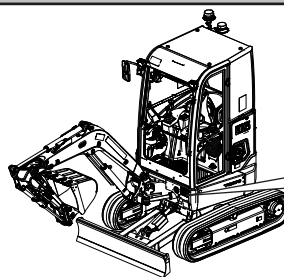
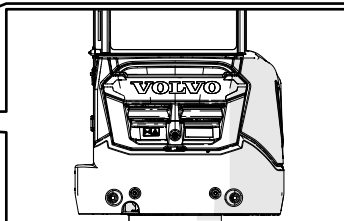

Volvo Construction Equipment	
Volvo Compact Equipment S.A.S. Rue Pierre Pngon, BP110, 01103 Balley, France.	
Type/Model	EXCAVATOR/JECR25D
Product Identification Number	"VCEC25DLxxxxxxxxx"
Machine mass kg	
Engine net power kW	
Engine gross power kW	
Manuf. year	
Made in	Assembled in
VOLVO	

2. Immobilisation/stabilization/lifting

Always approach the machine from the sides to stay out of the potential travel path. It may be difficult to determine, if the machine is running due to lack of noise.

immobilisation: Armrest (control lockout lever) in upper position
 stabilisation: working attachment and dozer blade on ground
 lifting: at marked lifting points

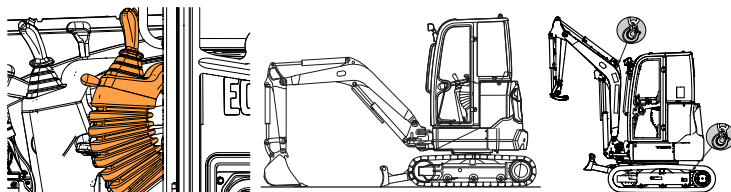

3. Disable direct hazardous/safety regulations

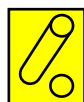

1 Turn off the ignition and remove the key.



2 Turn the battery disconnect switch in the cabin to the off position

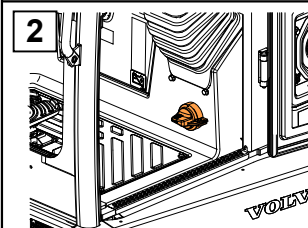
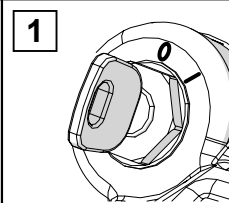

➡ If the machine is connected to a standard charging connector (Type 1 or Type 2)

- 1** Disconnect the charging cable from the power grid.
- 2** Interrupt the charging* by turn on the ignition and press the charging switch (1).
- 3** Disconnect the charging connector from the socket.

* The charging process can be forced to stop by opening the rear hood.

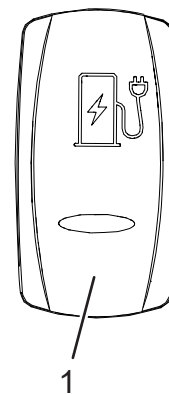

➡ If the machine is connected to a fast charging connector

- 1** Interrupt the charging* by turn on the ignition and press the charging switch (1) or press the stop button on the off-board charger.
- 2** Disconnect the charging connector from the socket.

* The charging process can be forced to stop by opening the rear hood.

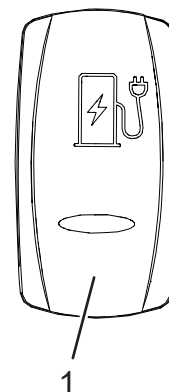

4. Stored energy / liquid / gases / solid

48 V lithium-ion battery

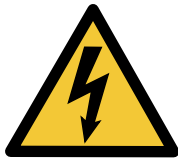

23 L

OIL

5. In case of fire



Use large sustained volume of water for lithium-ion battery related fire.



Class ABC fire extinguisher can be used if other materials are involved.



In case of thermal runaway, hydrogen fluoride can be released by the lithium-ion batteries.

6. In case of water submersion



The damage level of a submerged machine may not be visible.

Submersion in water can damage 12 V and 48 V components.

Handling a submerged machine without appropriate Personal Protective Equipment (PPE) will result in serious injury or death from electric shock.

Avoid any contact with 48 V cables and electric components.

If possible disable direct hazards (See chapter 3).

7. Towing / transportation / storage



If the traction batteries are damaged, there can be a risk of thermal or chemical reaction.

The electric machine met with an accident must be parked in a suitable place by maintaining a safe distance from other machines, vehicles, buildings and combustible objects.



Risk of late fire can happen, after the fire suppression or in case the lithium-ion batteries are damaged.

Observe the machine for a minimum period of 48 hours using a thermal infrared camera.

8. Important additional information



Do not cut any orange cables.

Do not touch any high voltage cables and electric components.

Do not perform any operation on a damaged machine without appropriate Personal Protective Equipment (PPE).

Identification number

53101813

Version number

01/2022

Page number

3