

V O L V O



Volvo Wheel Loaders 27.0-28.4 t 337 hp

L180

Volvo Construction Equipment

L180

Boost productivity and efficiency in rehandling, material handling, earthmoving and more. Faster cycle times, intelligent solutions, robust performance.



Fast cycle times

- Second generation load sensing hydraulics
- One of the highest hinge pin height in its class
- Increased hydraulic pump flow
- Bucket leveling function
- Entirely Volvo powertrain
- Reduced steps between gears for faster acceleration and smooth operation.
- Volvo Torque Parallel Linkage
- Volvo Attachments



Efficient and profitable operations

- Powerful and efficient engine
- Second generation OptiShift
- Direct lock-up gear change
- Reverse By Braking
- Smart control with reduced fuel consumption
- Attachment optimization
- External dry P-Brake, which eliminates drag losses
- Auto bucket fill
- Compatible with HVO

Boost productivity and efficiency with every load

Designed for maximum performance in a variety of segments including rehandling, material handling and earthmoving applications, the Volvo L180 Wheel Loader is your trusted partner for efficiency and reliability – building on a history of more than 70-years of Volvo Wheel Loader innovation. Engineered for fast cycle times, superior operator comfort and robust durability; take your productivity to the next level with intelligent features like Load Assist, On-Board Weighing, and Load Ticket, ensuring precision, uptime, and profitability.

The operator's choice



- Interactive, integrated Volvo Co-Pilot display
- Dynamic instrument cluster
- Comfort Drive Control (CDC)
- Customizable operator settings

A new level in cab comfort



- Most comfortable and quietest cab on the market
- Enhanced storage options
- New armrest, new cupholder and USB chargers
- Extensive range of seat - including premium seats with heating and cooling functionality.

Durable by design



- A durability leader in its class
- Outstanding uptime
- Volvo-renowned quality runs throughout every component
- Strong frame structure and robust axles, ideally matched to the Volvo powertrain
- Self-cleaning hydraulically driven cooling fan
- Outboard mounted brakes
- Front and rear axles are cooled by the oil circulation.

Industry leading serviceability



- Cab can be tilted to either a 30° or 70° angle
- Electronically operated engine hood
- Captive oil filters, captive fuel filters with electric pump
- Optional fast fuel fill
- Service light under the grille
- Brake wear indicators

Ultimate performance across a range of segments



- Rehandling
- Block handling
- Log loading
- Slag handling
- Quarry / Aggregate
- Waste & Recycling
- And more...

Safety inside and out



- Excellent in-cab visibility and field of vision
- High definition rear view camera integrated in the Volvo Co-Pilot display
- Volvo Smart View with 360°
- Collision Mitigation System
- Battery disconnect/service switch with lockout/tagout
- Radar detect system
- Orange handrails
- Remote door opening
- Enhanced LED lighting packages
- New service platform

Loaders and beyond



- Load Assist with On Board Weighing
- Load Ticket
- Connected Map with Performance Indicator
- Operator Coaching
- CareTrack telematics system

Fast cycle times

Achieve fast cycle times with second generation load sensing hydraulics, and one of the highest hinge pin heights in its class for increased dump clearance.

An increased hydraulic pump capacity and flow is designed to enhance the responsiveness of the hydraulic system and improve the lifting and lowering speed of the boom.

Boost productivity further with the bucket leveling function which automatically returns the bucket to level from both dump and curl positions, enhancing operator performance.

Fuel efficiency, lower emissions

Do more with less fuel, thanks to the industry-renowned fuel efficiency of Volvo Wheel Loaders.

Contributing to the fuel-efficient performance is Smart Control, powerful engine, second generation OptiShift, direct lock-up gear change, attachment optimization and external dry P-Brake, which eliminates drag losses.

What's more, the renewable synthetic diesel fuel, HVO (Hydro-treated Vegetable Oils), has been approved for use in Volvo Construction Equipment diesel engines with the potential to reduce CO₂ emissions by up to 90%.



Intuitive operator interface

Operators can stay in-the-know and focused on the task at hand thanks to all essential in-cab information conveniently displayed on just two screens.

The interactive, integrated Volvo Co-Pilot display offers easy control over essential functions such as media, camera settings, climate control and machine status.

This is combined with the dynamic instrument cluster, positioned in front of the steering wheel, which provides essential vehicle data at a glance.

Durable by design

A durability leader in its class, Volvo Wheel Loaders deliver outstanding uptime.

Volvo-renowned quality runs throughout every component, including a strong frame structure and robust axles, ideally matched to the Volvo powertrain.

The hydraulically driven cooling fan regulates component temperature and can be automatically reversed to permit self-cleaning of the cooling units.

For long service life, the brakes are outboard mounted and the front and rear axles are cooled by the oil circulation.

Safety first

Excellent in-cab visibility and field of vision is complemented by a host of safety-enhancing features including high definition rear view camera integrated in the Volvo Co-Pilot display, Collision Mitigation System and radar detect system that provides visual and audible alerts when encountering unseen objects.

Orange handrails and steps improve visibility for operators and maintenance staff, while automatic door opening allows the door to be opened with the key or button.

Ultimate performance across a range of applications

Get ready to achieve maximum results across a wide range of applications in the Volvo L180 thanks to a range of options and attachments which equip the machine to take on the unique challenges and requirements of your segment.

A comprehensive range of attachments designed to work in perfect harmony provide the ideal match of machine and attachment to succeed across applications including rehandling, log loading, slag handling, block handling and more.



Volvo L180 in detail

Engine

V-ACT Stage V, 13-liter, 6-cylinder straight turbocharged diesel engine with 4 valves per cylinder, overhead camshaft, and electronically controlled unit injectors. The engine has wet replaceable cylinder liners and replaceable valve guides and valve seats. The throttle application is transmitted electrically either from the throttle pedal or the optional hand throttle.

Air cleaning: 2 stages.

Cooling system: Hydrostatic, electronically controlled fan and intercooler of the air-to-air type.

| | | |
|-------------------------|-------|---------------|
| Engine | Volvo | D 13J |
| Max. power at | r/min | 1 300 - 1 400 |
| ECE R120 net | kW | 251 |
| | hp | 341 |
| ISO 9249, SAE J1349 net | kW | 250 |
| | hp | 340 |
| Max. torque at | r/min | 1 000 |
| ECE R120 net | Nm | 2 071 |
| ISO 9249, SAE J1349 net | Nm | 2 065 |
| Economic working range | r/min | 800 - 1 600 |
| Displacement | l | 12.8 |

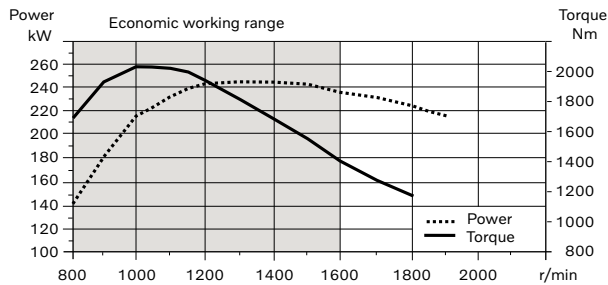

Drivetrain

Torque converter: The single-stage torque converter with lockup and direct lockup shifting between gears provides seamless transitions and enhanced performance.

Transmission: The electronically controlled Volvo countershaft transmission features the Full Automatic Power Shift (FAPS) function, which offers fully automatic shifting in all four forward gears and from the second to the fourth gear in reverse. It is complemented by a mode selector with four gear-shifting programs. The Rimpull Control function helps prevent wheel spin and optimizes bucket filling. The single lever control and the Pulse Width Modulation (PWM) valves ensure effortless, fast, and smooth shifting, providing higher precision and reliability.

Axles: Volvo's fully floating drive shafts with planetary hub reductions and cast iron axle housing. The fixed front axle features a 100% differential lock, while the oscillating rear axle offers an optional limited-slip differential.

| | | |
|---------------------------------------|-------|----------------------|
| Transmission | Volvo | HTL 223 |
| Torque multiplication, stall ratio | | 2.09:1 |
| Maximum speed, forward/reverse | | |
| 1st gear | km/h | 6.1 |
| 2nd gear | km/h | 12.6 |
| 3rd gear | km/h | 23.5 |
| 4th gear | km/h | 38 |
| Measured with tires | | 26.5 R25 L3 |
| Front axle/rear axle | | Volvo/AWB 40B/40B |
| Rear axle oscillation | ± ° | 15 |
| Ground clearance | mm | 490 |
| at oscillation | ° | 15 |

Electrical system

Central warning system: Contrinsic electrical system with central warning light and buzzer for following functions: - Serious engine fault - Low steering system pressure - Over speed warning engine - Interruption in communication (computer fault) Central warning light and buzzer with the gear engaged for the following functions. - Low engine oil pressure - High engine oil temperature - High charge air temperature - Low coolant level - High coolant temperature - High crank case pressure - Low transmission oil pressure - High transmission oil temperature - Low brake pressure - Engaged parking brake - Fault on brake charging - Low hydraulic oil level - High hydraulic oil temperature - Overspeeding in engaged gear - High brake cooling oil temperature front and rear axles.

| | | |
|--------------------------------|-----|------------|
| Voltage | V | 24 |
| Batteries | V | 2 x 12 |
| Battery capacity | Ah | 2 x 170 |
| Cold cranking capacity, approx | A | 1 000 |
| Alternator rating | W/A | 2 280 / 80 |
| Starter motor output | kW | 7 |

Brake system

Service brake: Volvo dual-circuit system with nitrogen charged accumulators. Outboard mounted hydraulically operated, fully sealed oil circulation-cooled wet disc brakes. The operator can select automatic disengagement of the transmission when braking using Contrinsic.

Parking brake: Dry disc brake. Applied by spring force, electro-hydraulic release with a switch on the instrument panel.

Secondary brake: Dual brake circuits with rechargeable accumulators. One circuit or the parking brake fulfills all safety requirements.

Standard: The brake system complies with the requirements of ISO 3450.

| | |
|--|---------------------|
| Number of brake discs per wheel front/rear | 1/1 |
| Accumulators | l 2 x 1.0 + 1 x 0.5 |

Cab

Instrumentation: All important information is centrally located in the operator's field of vision. Display for Contrinsic monitoring system.

Heater and defroster: Heater coil with filtered fresh air and fan with auto and manual settings (11 speeds). Defroster vents for all window areas.

Operator's seat: Operator's seat with adjustable air suspension and retractable seatbelt. The seat is mounted on a bracket on the rear cab wall and floor. The forces from the retractable seatbelt are absorbed by the seat rails.

Standards: The cab is tested and approved according to ROPS (ISO 3471, SAE J1040), FOPS (ISO 3449). The cab meets with requirements according to SAE J386 («Operator Restraint System»). Refrigerant of the type R134a is used when this machine is equipped with air conditioning. Contains fluorinated greenhouse gas R134a, Global Warming Potential 1.430 t CO₂-eq.

Emergency exit: Use emergency hammer to break window

| | | |
|-----------------------------|---------------------|-----|
| Ventilation | m ³ /min | 9 |
| Heating capacity | kW | 16 |
| Air conditioning (optional) | kW | 7.5 |

Sound Level

| | | |
|---|----|-----|
| Sound pressure level in cab according to ISO 6396 | | |
| L _{pA} | dB | 70 |
| External sound level according to ISO 6395 | | |
| L _{WA} | dB | 108 |

Hydraulic System

System supply: Two load-sensing axial piston pumps with variable displacement. The steering function always has priority.
Valves: Double-acting 2-spool valve. The main valve is electro operated.
Lift function: The valve has four positions; raise, hold, lower and floating position. Inductive/magnetic automatic boom kickout can be switched on and off and is adjustable to any position between maximum reach and full lifting height.
Tilt function: The valve has three functions including rollback, hold and dump. Inductive/magnetic automatic tilt can be adjusted to the desired bucket angle.
Cylinders: Double-acting cylinders for all functions.
Filter: Full flow filtration through 10 micron (absolute) filter cartridge.

| | | |
|---|-------|-------|
| Working pressure maximum, pump 1 for working hydraulic system | MPa | 29 |
| Flow | l/min | 252 |
| at | MPa | 10 |
| engine speed | r/min | 1 900 |
| Working pressure maximum, pump 2 for steering-, brake-, pilot- and working hydraulic system | MPa | 31 |
| Flow | l/min | 202 |
| at | MPa | 10 |
| engine speed | r/min | 1 900 |
| Working pressure maximum, pump 3 for brake- and cooling fan system | MPa | 25 |
| Flow | l/min | 83 |
| at | MPa | 10 |
| engine speed | r/min | 1 900 |
| Pilot system, working pressure | MPa | 3.5 |
| Cycle times | | |
| Lift | s | 6.4 |
| Tilt | s | 1.8 |
| Lower, empty | s | 3.3 |
| Total cycle time | s | 11.5 |

Steering system

Steering system: Load-sensing hydrostatic articulated steering.
System supply: The steering system has priority feed from a load-sensing axial piston pump with variable displacement.
Steering cylinders: Two double-acting cylinders.

| | | |
|----------------------|-------|-----|
| Steering cylinders | | 2 |
| Cylinder bore | mm | 100 |
| Rod diameter | mm | 60 |
| Stroke | mm | 525 |
| Working pressure | MPa | 21 |
| Maximum flow | l/min | 202 |
| Maximum articulation | ± ° | 37 |

Service Refill

Service accessibility: Large, easy-to-open hood covering whole engine compartment, electrically operated. Fluid filters and component breather air filters promote long service intervals. A quick-fit adapter on the hydraulic tank provides faster hydraulic oil fill. Possibility to monitor, log and analyze data to facilitate troubleshooting.

| | | |
|--------------------|---|-----|
| Fuel tank | l | 366 |
| DEF/AdBlue® tank | l | 31 |
| Engine coolant | l | 55 |
| Hydraulic oil tank | l | 156 |
| Transmission oil | l | 48 |
| Engine oil | l | 50 |
| Axle oil front | l | 46 |
| Axle oil rear | l | 55 |

Lift Arm System

Torque Parallel linkage (TP-linkage) with high breakout torque and parallel action throughout the entire lifting range.

| | | |
|---------------------|----|-----|
| Lift cylinders | | 2 |
| Cylinder bore | mm | 180 |
| Piston rod diameter | mm | 90 |
| Stroke | mm | 806 |
| Tilt cylinder | | 1 |
| Cylinder bore | mm | 240 |
| Piston rod diameter | mm | 120 |
| Stroke | mm | 480 |

Specifications

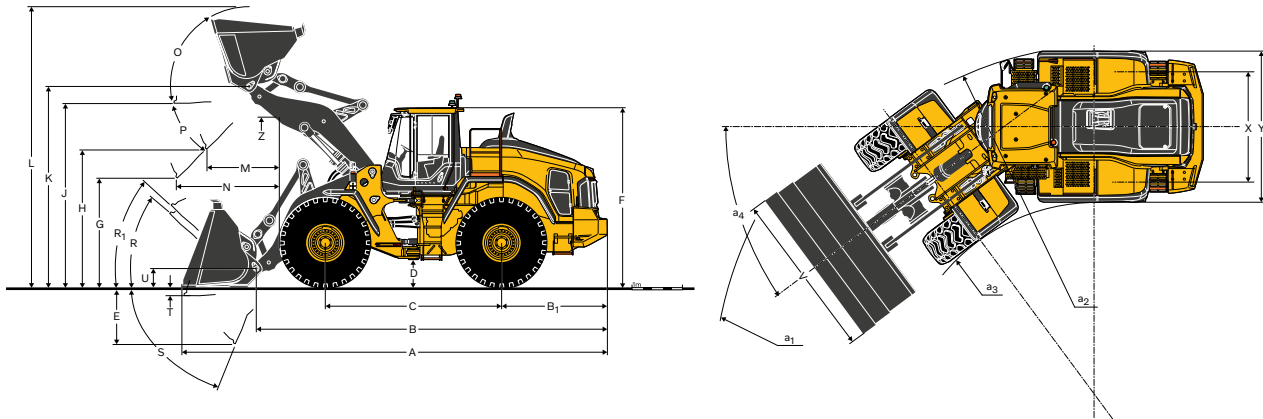

DIMENSIONS

Tires: 26.5 R25 L3.

| | Unit | L180K | | |
|------------------|--|---------------|-----------|-------|
| | | Standard boom | Long boom | |
| B | Overall length w/o bucket / attachm. bracket | mm | 7 200 | 7 630 |
| B ₁ | Rear overhang | mm | 2 240 | 2 240 |
| C | Wheel base | mm | 3 550 | 3 550 |
| D | Ground clearance | mm | 490 | 480 |
| F | Height to top of ROPS | mm | 3 590 | 3 580 |
| G | Specific height for reach (N) | mm | 2 134 | 2 134 |
| J | Lift height under level bucket | mm | 4 170 | 4 680 |
| K | Height to hinge pin | mm | 4 590 | 5 090 |
| O | Rollback angle, max., fully raised | ° | 57 | 55 |
| P _{max} | Dump angle, max., fully raised | ° | 46 | 46 |
| R | Rollback angle, max., at ground level | ° | 44 | 48 |
| R ₁ * | Rollback angle at SAE carry position | ° | 48 | 53 |
| S | Digging angle, max. | ° | 71 | 63 |
| T | Digging depth | mm | 134 | 216 |
| U | Hinge pin height at carrying position | mm | 570 | 660 |
| X | Track width | mm | 2 280 | 2 280 |
| Y | Machine width over tire | mm | 2 960 | 2 960 |
| Z | Max. load-over height | mm | 3 810 | 4 170 |
| a ₂ | Turning radius outer circle | mm | 6 790 | 6 790 |
| a ₃ | Turning radius inner circle | mm | 3 820 | 3 820 |
| a ₄ | Max. articulation | ±° | 37 | 37 |

* Carry position SAE

Bucket: WLA87118 4.8 m³ GP STE BOE

Grapples:

Sales code: WLA80027

Operating weight (incl. logging cw 1 140 kg): 29 200 kg

Operating load: 8 710 kg

Where applicable, specifications and dimensions are according to ISO 7131, SAE J732, ISO 7546, SAE J742, ISO 14397, SAE J818.

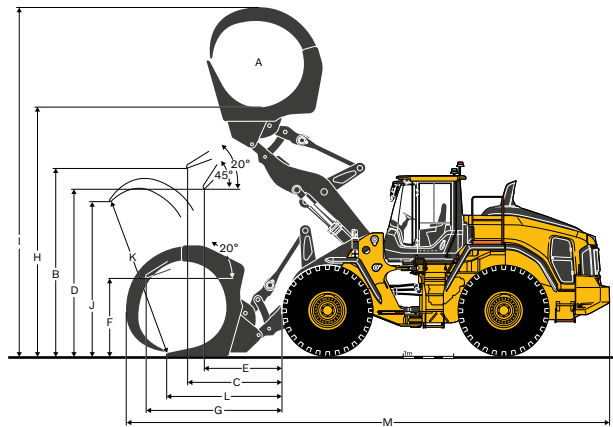









DIMENSIONS

Tires: 775/65 R29 L3

| | Unit | L180K |
|--|----------------|-------|
| A Grapple Area | m ² | 3.5 |
| B Dumping clearance at max. HPH, dump 20° | mm | 3 980 |
| C Dumping reach at max. HPH, dump 20° | mm | 2 030 |
| D Dumping clearance at max. HPH, dump 45° | mm | 3 270 |
| E Dumping reach at max. HPH, dump 45° | mm | 1 600 |
| F Dumping clearance at parallel lifting arm pos. | mm | 1 700 |
| G Dumping reach at parallel lifting arm pos. | mm | 3 040 |
| H Max. dumping clearance | mm | 5 290 |
| I Overall operating height | mm | 7 730 |
| J Height upper clamp at K | mm | 3 370 |
| K Max. opening width | mm | 3 720 |
| L Reach at ground position | mm | 2 410 |
| M Overall machine length | mm | 9 990 |

Specifications

L180K

| | | REHANDLING ⁽¹⁾ | | | | GENERAL PURPOSE | | | ROCK ⁽²⁾ | LIGHT MATERIAL | LONG BOOM |
|--|----------------|---|---|---|---|---|--|---|---|---|-----------|
| | |  |  |  |  |  |  |  |  |  | - |
| Tires 26.5 R25 L3 | | WLA86752 | WLA86754 | WLA86755 | WLA86757 | WLA87106 | WLA87113 | WLA87118 | WLA87518 | WLA92117 | - |
| | | 4.8 m ³ STE P BOE | 5.2 m ³ STE P BOE | 5.5 m ³ STE P BOE | 5.8 m ³ STE H BOE | 4.4 m ³ STE P T SEG | 4.6 m ³ STE P T SEG | 4.8 m ³ STE P BOE | 4.2 m ³ SPN P T SEG | 7.8 m ³ LM P BOE | - |
| Volume, heaped ISO/SAE | m ³ | 4.8 | 5.2 | 5.5 | 5.8 | 4.4 | 4.6 | 4.8 | 4.2 | 7.8 | - |
| Volume at 110% fill factor | m ³ | 5.3 | 5.7 | 6.1 | 6.4 | 4.8 | 5.1 | 5.3 | 4.6 | 8.6 | - |
| Static tipping load, straight | kg | 23 820 | 23 710 | 23 540 | 22 600 | 21 720 | 21 650 | 21 650 | 22 760 | 20 650 | -3 810 |
| at 35° turn | kg | 21 170 | 21 050 | 20 890 | 20 010 | 19 320 | 19 250 | 19 250 | 20 190 | 18 300 | -3 480 |
| at full turn | kg | 20 860 | 20 750 | 20 590 | 19 710 | 19 050 | 18 970 | 18 980 | 19 900 | 18 030 | -3 440 |
| Breakout force | kN | 225 | 224 | 216 | 199 | 236 | 232 | 226 | 212 | 174 | +4.0 |
| A Overall length | mm | 8 900 | 8 900 | 8 970 | 9 110 | 9 010 | 9 040 | 8 890 | 9 190 | 9 360 | +470 |
| E Digging depth, max dump (S) | mm | 1 430 | 1 430 | 1 490 | 1 620 | 1 530 | 1 560 | 1 420 | 1 690 | 1 860 | +30 |
| H ⁽³⁾ Dump clearance | mm | 3 180 | 3 170 | 3 130 | 3 110 | 3 100 | 3 080 | 3 180 | 2 990 | 2 850 | +510 |
| L Overall operating height | mm | 6 220 | 6 210 | 6 280 | 6 380 | 6 220 | 6 260 | 6 290 | 6 350 | 6 420 | +510 |
| M ⁽³⁾ Dump reach | mm | 1 210 | 1 210 | 1 260 | 1 450 | 1 300 | 1 320 | 1 200 | 1 410 | 1 540 | -20 |
| N ⁽³⁾ Reach at 45° discharge, pos. G | mm | 1 960 | 1 960 | 1 990 | 2 040 | 2 010 | 2 020 | 1 960 | 2 080 | 2 050 | +410 |
| V Bucket width | mm | 3 200 | 3 400 | 3 400 | 3 400 | 3 200 | 3 200 | 3 200 | 3 230 | 3 400 | 0 |
| a ₁ Outer clearance circle (diameter) | mm | 15 040 | 15 230 | 15 260 | 15 330 | 15 110 | 15 120 | 15 040 | 15 240 | 15 480 | +340 |
| Operating weight without load | kg | 28 550 | 28 640 | 28 750 | 29 160 | 27 390 | 27 450 | 27 440 | 29 190 | 27 880 | +310 |

⁽¹⁾ Measured with additional counterweight.





⁽²⁾ Measured with 26.5 R25 L5 tires.

⁽³⁾ Measured to the tip of the bucket teeth or bolt-on edge. Dump height to bucket edge measured at 45° dump angle.

Note: This only applies to genuine Volvo attachments.

Bucket Selection Chart

The chosen bucket is determined by the density of the material and the expected bucket fill factor. The actual bucket volume is often larger than the rated capacity, due to the features of the TP linkage, including an open bucket design, good rollback angles in all positions and good bucket filling performance. The example represents a standard boom configuration. Example: Sand and gravel. Fill factor ~ 105%. Density 1.6 t/m³. Result: The 4.6 m³ bucket carries 4.8 m³. For optimum stability always consult the bucket selection chart.

| Material | Bucket fill, % | | Material density, t/m ³ | ISO/SAE bucket volume, m ³ | Actual volume, m ³ |
|-------------|----------------|---|------------------------------------|---------------------------------------|-------------------------------|
| Earth/Clay | ~ 110 |  | ~ 1.7 | 4.4 | ~ 4.8 |
| | | ~ 1.6 | 4.6 | ~ 5.1 | |
| | | ~ 1.5 | 4.8 | ~ 5.3 | |
| Sand/Gravel | ~ 105 |  | ~ 1.7 | 4.4 | ~ 4.6 |
| | | ~ 1.6 | 4.6 | ~ 4.8 | |
| | | ~ 1.5 | 4.8 | ~ 5.1 | |
| Aggregate | ~ 100 |  | ~ 1.8 | 5.2 | ~ 5.2 |
| | | ~ 1.7 | 5.5 | ~ 5.5 | |
| | | ~ 1.6 | 5.8 | ~ 5.8 | |
| Rock | ≤100 |  | ~ 1.7 | 4.3 | ~ 4.3 |

The size of rock buckets is optimized for optimal penetration and filling capability rather than the density of the material.

| Type of boom | Type of bucket | ISO/SAE Bucket volume | Material density: (t/m ³) | | | | | | | |
|----------------|--------------------|-----------------------|---------------------------------------|-----|-----|-----|-----|-----|-----|-----|
| | | | 0,8 | 1,0 | 1,2 | 1,4 | 1,6 | 1,8 | 2,0 | |
| Standard boom | Rehandling* | 5,2 m ³ | | | | | | 5,5 | 5,2 | |
| | | 5,5 m ³ | | | | | 5,8 | 5,5 | | |
| | | 5,8 m ³ | | | | 6,1 | 5,8 | | | |
| | General purpose | 4,4 m ³ | | | | | | 4,8 | 4,4 | |
| | | 4,6 m ³ | | | | | 5,1 | 4,6 | | |
| | | 4,8 m ³ | | | | | 5,3 | 4,8 | | |
| Rock | 4,2 m ³ | | | | | | 4,2 | 4,0 | | |
| Light material | 7,8 m ³ | 7,8 | | | | | | | | |
| Long boom | Rehandling* | 4,8 m ³ | | | | | | 5,0 | 4,8 | |
| | | 5,2 m ³ | | | | | 5,5 | 5,2 | | |
| | General purpose | 4,4 m ³ | | | | | | 4,8 | 4,4 | |
| | | 4,2 m ³ | | | | | | | 4,2 | 4,0 |
| | Rock | 4,2 m ³ | | | | | | | 4,2 | 4,0 |
| | Light material | 7,8 m ³ | 7,8 | | | | | | | |

Bucket fill
110% 105% 100% 95%

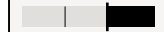

Pin-on

How to read bucket fill factor

* Including counterweight

SUPPLEMENTAL OPERATING DATA

| Tires 26.5 R25 L3 | Unit | Standard boom | | | Long boom | | |
|-------------------------|------|---------------|-------------|---------------|-------------|-------------|---------------|
| | | 26.5 R25 L4 | 26.5 R25 L5 | 775/65 R29 L3 | 26.5 R25 L4 | 26.5 R25 L5 | 775/65 R29 L3 |
| Width over tires | mm | +10 | +30 | +170 | +10 | +30 | +170 |
| Ground clearance | mm | +20 | +30 | +10 | +20 | +30 | +10 |
| Tipping load, full turn | kg | +350 | +800 | +590 | +300 | +670 | +510 |
| Operating weight | kg | +490 | +1 470 | +770 | +490 | +1 470 | +770 |

Equipment

STANDARD EQUIPMENT

Engine

Exhaust after-treatment system

Two stage air cleaner, primary and secondary filter

Preheating of induction air

Fuel pre-filter with water trap

Fuel filter

Electric fuel prime pump

Crankcase breather oil trap

Exterior radiator air intake protection

Drivetrain

Automatic Power Shift

Fully automatic gearshifting, 1-4

PWM-controlled gearshifting

Forward and reverse switch by hydraulic lever console

Rimpull control

Smart control

Indicator glass for transmission oil level

Differentials: Front, 100% hydraulic diff lock. Rear, conventional.

Optishift with Lock-up, RBB

Lock-up first gear

Electrical system

24V, pre-wired for optional accessories

12.8-inch High Definition vertical Co-Pilot display

Alternator 24V/130A/3479W

Battery disconnect (service) switch

Electric horn

Lighting:

Twin halogen front headlights with high and low beams

Parking lights

Double brake and tail lights

Turn signals with flashing hazard light function

Halogen work lights (2 front and 2 rear)

Dual LED reversing strobe lights

STANDARD EQUIPMENT

Dynamic Instrument Cluster

8-inch dynamic instrument cluster display

Fuel consumption

Diesel Exhaust Fluid/AdBlue consumption

Ambient temperature

Clock

Warning and indicator lights:

Battery charging

Parking brake

Warning and display message:

Regeneration

Engine coolant temperature

Charge-air temperature

Engine oil temperature

Engine oil pressure

Transmission oil temperature

Transmission oil pressure

Hydraulic oil temperature

Brake pressure

Parking brake applied

Brake charging

Overspeed at direction change

Axle oil temperature

Steering pressure

Crankcase pressure

Attachment lock open

Safety Belt Warning

Level warnings:

Fuel level

Diesel Exhaust Fluid/AdBlue level

Engine oil level

Engine coolant level

Transmission oil level

Hydraulic oil level

Washer fluid level

Climate control temperature and fan speed

Speed indicator

Engine revolutions per minute indicator

Engine torque reduction in case of malfunction indication:

High engine coolant temperature

High engine oil temperature

Low engine oil pressure

High crankcase pressure

High charge-air temperature

Engine shutdown to idle in case of malfunction indication:

High transmission oil temperature

Slip in transmission clutches

Start interlock when gear is engaged

Integrated Volvo Co-Pilot

Machine integration

Machine information

Machine settings

Service information

Service mode

Smart View with rear view camera

Climate controls

Radio and media (with Bluetooth and USB connection)

Load Assist portfolio

Operator Coaching Start

Toolbox applications

Remote support

Help center (digital operator's manual)

STANDARD EQUIPMENT

Hydraulic System

Main valve, double acting 2-spool with hydraulic pilots

Variable displacement axial piston pumps (3) for:

- 1 Working hydraulics, Pilot hydraulics and Brake system
- 2 Working hydraulics, Pilot hydraulics, Steering and Brake system
- 3 Cooling fan and Brake system

Secondary steering with automatic test function

Electro-hydraulic servo controls

Electronic hydraulic lever lock

Automatic boom kick-out

Automatic bucket positioner

Double-acting hydraulic cylinders

Indicator glass for hydraulic oil level

Hydraulic oil cooler

Brake system

Dual brake circuits

Dual brake pedals

Secondary brake system

Parking brake, electro-hydraulic

Brake wear indicators

Cab

ROPS (ISO 3471), FOPS (ISO 3449)

Harness Anchor Points

Single key kit door/start

Acoustic inner lining

Cigarette lighter, 24 V power outlet

Lockable door

Cab heating with fresh air inlet and defroster

Fresh air inlet with two filters

Automatic heat control

Floor mat

Interior lights

Interior rear-view mirrors

Dual exterior rear-view mirrors

Sliding window, right side

Tinted windshield glass

Retractable seatbelt (SAE J386)

Adjustable steering wheel

Storage compartment

Document pocket

Sun visor

Beverage holder

Windshield washer front and rear

Windshield wipers front and rear

Interval function for front and rear wipers

STANDARD EQUIPMENT

Service and Maintenance

Engine oil remote drain and fill

Volvo High Performance oil filters with 1,000 hours service interval

Transmission oil remote drain and fill

Quick-fit transmission oil change

Lubrication manifolds, ground accessible

Pressure check connections: transmission and hydraulic, quick-connects

Quick-fit hydraulic oil fill

Service platform on the front frame

Tool box, lockable

External equipment

Orange hand rails

Fenders, front and rear

Reflecting stickers (decals), machine contour and cab

Viscous cab mounts

Rubber engine and transmission mounts

Frame, joint lock

Vandalism lock prepared for
Engine compartment
Radiator grille

Lifting eyes

Tie-down eyes

Fabricated counterweight

Counterweight, pre-drilled for optional guards

Equipment

OPTIONAL EQUIPMENT

Engine

Air pre-cleaner, cyclone type
Air pre-cleaner, oil-bath type
Air pre-cleaner, turbo type II
Air pre-cleaner, turbo type III
Engine auto shutdown
Engine delayed shutdown
Engine block heater 230V/110V
Fuel fill strainer
Fuel heater
Hand throttle control
Max. fan speed, hot climate
Radiator, corrosion-protected
Reversible cooling fan
Reversible cooling fan and axle oil cooler

Drivetrain

Diff lock front 100%, Limited Slip rear
Speed limiter
Wheel/axle seal guards

Electrical system

Anti-theft device
Emergency stop
Locking device, Tag out Lock out
License plate holder, lighting
Rear view mirrors, Long arm
Rear view mirrors, adjustable, el.heated, Long arm
Reduced function working lights, reverse gear activated
Reverse alarm, audible
Reverse alarm, white noise
Seatbelt indicator, external
Shortened headlight support brackets
Side marker lamps
Warning beacon LED
Warning beacon LED automatic
Halogen Economy package
Halogen Feature package
Halogen Power package
Headlights, assymetric left, halogen
Working lights, attachments, halogen
LED Economy package
LED Feature package
LED Power package
LED Intense package
Headlights, assymetric Left, LED
Headlights, assymetric Right, LED
Working lights, attachments, LED
Electrical distribution unit 24 volt
Parking brake alarm, audible for air susp seats
Jump start connector, ISO-Type
Max Boom height
Can Bus Interface

OPTIONAL EQUIPMENT

Integrated Volvo Co-Pilot

Tire pressure monitoring system
Handsfree telephone
Smart View
Smart View with 360°
Smart View with radar detect system
Forward camera
Dual forward cameras
Collision Mitigation System
Load Assist portfolio
Load Assist OBW
Load Assist Task Modes
Operator Coaching Advanced
Site services enabled
Site Operations
Connected Map
Load Ticket
File Upload
Performance indicators
Task Manager
Media player

Hydraulic System

Boom suspension system
Separate attachment locking
Arctic kit, for 3rd function
Boom cylinder hose and tube guards
Hydraulic fluid, biodegradable, Volvo
Hydraulic fluid, fire-resistant
Hydraulic fluid, for hot climate
Hydraulic 3rd function
hydraulic 3rd-4th function
Single lever control, hydraulics 2 functions
Single lever control, hydraulics 3 functions
Single lever control, hydraulics 4 functions

Brake system

Oil cooler and filter front & rear axle
Stainless steel, brake lines

OPTIONAL EQUIPMENT

Cab

| |
|--|
| Anchorage for Operator's manual |
| Automatic Climate Control, ACC |
| ACC control panel, with Fahrenheit scale |
| Asbestos dust protection filter |
| Ashtray |
| Cab air pre-cleaner, cyclone type |
| Carbon filter |
| Cover plate, under cab |
| Lunch box holder |
| Volvo Armrest, operator's seat, left |
| Operator's seat, Mechanical ISRI, 2pt seat belt |
| Operator's seat, Volvo Air Suspension, Heavy Duty, 2pt seat belt |
| Operator's seat, Volvo Air Suspension, 2pt seat belt |
| Operator's seat, Volvo Air Suspension, 3pt seat belt |
| Operator's seat, Comfort ISRI, 2pt seat belt |
| Operator's seat, Comfort ISRI, 3pt seat belt |
| Operator's seat, Premium ISRI, 2pt seat belt |
| Operator's seat, Premium ISRI, 3pt seat belt |
| Subwoofer |
| Steering wheel knob |
| Sun blinds, rear windows |
| Sun blinds, side windows |
| Timer cab heating |
| Window, sliding, door |
| Universal door/ignition key |
| Remote door opener |
| Forward view mirrors |
| Cab heater power outlet 240V |
| Cab, Hot applications. Roof, steel |
| Fire extinguisher cab |
| Outside steel protection cab |
| Rear view mirrors long arm, cab |
| Reinforced windshield, flat |

Service and Maintenance

| |
|--|
| Automatic lubrication system |
| Automatic lubrication system for long boom |
| Grease nipple guards |
| Oil sampling valve |
| Quick engine oil change |
| Refill pump for grease to lube system |
| Tool kit |
| Wheel nut wrench kit |
| CareTrack, GSM, GSM/Satellite |
| Telematics, Subscription |
| Belly guard front |
| Belly guard rear |
| Cover plate, heavy-duty, front frame |
| Cover plate, rear frame |
| Cab roof, heavy-duty |
| Guards for front headlights |
| Guards for radiator grill |
| Guards for tail lights |
| Windows, side and rear guards |
| Windshield guard |
| Corrosion protection, painting of machine |
| Corrosion protection, painting of attachment bracket |
| Option for machines without dinitrol |
| Bucket Teeth protection |

OPTIONAL EQUIPMENT

Wheel/Tires

| |
|------------|
| 26.5 R25 |
| 775/65 R29 |
| 875/65 R29 |

External equipment

| |
|---|
| Cab ladder, rubber-suspended |
| Escape Ladder, left fender |
| Handles on counterweight |
| Deleted front mudguards |
| Fire suppression system |
| Mudguards, full cover, front and rear for 80-series tires |
| Mudguards, full cover, front and rear for 65-series tires |
| Long boom |
| Tow hitch |

Other equipment

| |
|---|
| CE-marking |
| Comfort Drive Control (CDC) |
| Counterweight, logging |
| Counterweight, signal painted, chevrons |
| Sound decal, EU |
| Sound decal, USA |
| Noise reduction kit, exterior |
| Block Handler package |
| Log Loader package |
| Rehandler package |
| 3-Pass Rehandler package |
| Scrap Handler package |
| Slag Handler package |
| Waste Handler package |

Attachments

| |
|---|
| Buckets: |
| Rock straight or spade nose |
| General purpose |
| Rehandling |
| Side dump |
| Light material |
| High tip |
| Refuse |
| Wear parts: |
| Bolt-on and weld-on bucket teeth |
| Segments |
| Cutting edge in three sections, bolt-on |
| Fork equipment |
| Material handling arm |
| Log grapples |
| Log pusher |

Not all products are available in all markets. Under our policy of continuous improvement, we reserve the right to change specifications and design without prior notice. The illustrations do not necessarily show the standard version of the machine.

V O L V O