



Volvo Construction Equipment

# L350F

Volvo Wheel Loaders



# A passion for performance

At Volvo Construction Equipment, we're not just coming along for the ride. Developing products and services that raise productivity – we are confident we can lower costs and increase profits for industry experts. Part of the Volvo Group, we are passionate about innovative solutions to help you work smarter – not harder.

## Helping you to do more.

Doing more with less is a trademark of Volvo Construction Equipment. High productivity has long been married to low energy consumption, ease of use and durability. When it comes to lowering life-cycle costs, Volvo is in a class of its own.

## Designed to fit your needs.

There is a lot riding on creating solutions that are suited to the particular needs of different industry applications. Innovation often involves high technology – but it doesn't always have to. Some of our best ideas have been simple, based on a clear and deep understanding of our customers' working lives.



## You learn a lot in 180 years.

Over the years, Volvo has advanced solutions that have revolutionized the use of construction equipment. No other name speaks Safety louder than Volvo. Protecting operators, those around them and minimizing our environmental impact are traditional values that continue to shape our product design philosophy.

## We're on your side.

We back the Volvo brand with the best people. Volvo is truly a global enterprise, one that is on standby to support customers quickly and efficiently – wherever they are.

## We have a passion for performance.



Volvo Trucks



Renault Trucks





Mack Trucks



UD Trucks



Volvo Buses



Volvo Construction Equipment



Volvo Penta



Volvo Financial Services

# L350F leads the Total Cost of Ownership challenge

The Volvo L350F is built to deliver reliability and performance that are second to none. This wheel loader is purpose-built to provide outstanding results in a range of applications.



The Volvo L350F is designed to provide the lowest possible total cost of ownership.

This machine combines outstanding productivity, durability and reduced fuel consumption to lower the cost of production per ton. Low repair and maintenance costs further ensure a high return on investment when working in all applications.





**+ 300 000 tons**

**- 13 000 \$**

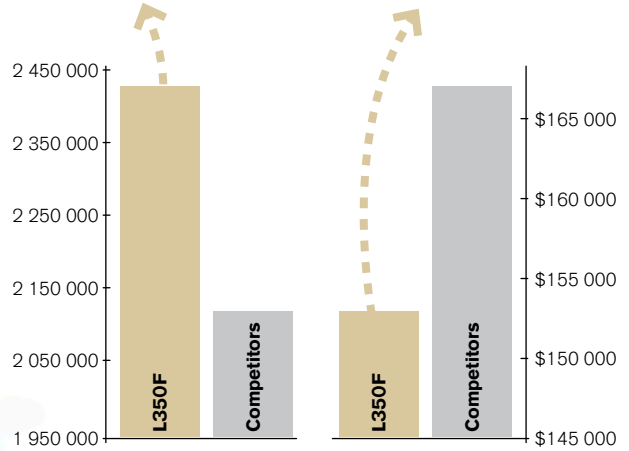

**PRODUCTION:**  
ton per 2 500 hours

**FUEL COST:**  
\$ per 2 500 hours

**First launched in 2007, the L350F has been designed and built with Volvo Construction Equipment's outstanding experience and expertise.**

More than 700 of these durable machines are working in 50 countries across the globe. The L350F is a trusted partner in a range of tough applications, from mining and quarrying to building and heavy infrastructure work.



# Move it and move more

The Volvo L350F can produce up to 14% more than competitor machines in its size class. Higher productivity means less time is required to reach the production target leading to lower costs per hour.

## Machine concept

The L350F is the pinnacle of Volvo's wheel loader concept. It's the perfect combination of power and balance that enables it to move quickly, carry more and deliver a strong performance. It is ideally sized for a range of applications.



## Drive train

The Volvo L350F powertrain, specially developed by Volvo, is perfectly matched to work in harmony and deliver unrivalled performance. The lock-up converter decreases cycle times in load and carry productions resulting in higher productivity.



## Boom Suspension System (BSS)

With the optional Volvo Boom Suspension System (BSS), you can negotiate the load and carry distance with faster speed and less spillage, with the BSS effectively dampening the shock from the ground. Our testing shows the BSS can boost productivity by up to 13%.



## Comfortable cab

Cab comfort affects productivity on a daily basis. Volvo is dedicated to developing a productive working environment, creating the Volvo care cab to ensure operator comfort. A comfortable operator is a productive one.





“ ”

At a large quarry in Germany, an L350F was instrumental in producing and transporting 1.2 million tonnes of limestone a year. The L350F loaded a 60 ton hauler in only five passes, ensuring a highly profitable rate of production.

**L350F in action**





A quarry in the UK used a Volvo L350F to load more than 500,000 tons of blasted limestone a year. The L350F replaced two older machines and was chosen for its excellent fuel economy and an outstanding performance.

### **L350F in action**



# Fuelling down your costs

Fuel consumption accounts for up to 30% of the total owning and operating cost of wheel loader in this size class. By using the Volvo L350F, you can ensure your operating costs go down. This machine offers at least 10% lower fuel consumption than it size class competitors.

## Load sensing hydraulics

The intelligent electro-hydraulic load-sensing system delivers power to suit every load for optimal fuel efficiency. The system gives you as much power as you need depending on the load size and works together with the lifting arm, transmission, engine and steering system.



## Volvo engine and intelligent hot shutdown

The turbocharged Volvo engine provides optimal power and high torque at low engine speeds, supplying power to both the hydraulic system and the drivetrain for enhanced production and uptime. The engine is equipped with a hot shut down function to advise the operator when it is suitable to shut off the engine, increasing the service life of the turbocharger.



## EcoOperator

Volvo's EcoOperator training is an easy way to save money and the environment. It teaches operators correct machine operation and maneuvering as well as how to plan their work in the smartest way. It helps to save on fuel, increase production and spend less money on maintenance and reduces operator stress.

## APS and Lock Up converter

The fully automatic power shifted transmission is designed by Volvo to fit perfectly with the rest of the drivetrain for high efficiency. In addition, the automatic lock-up torque converter combines with the Volvo engine to deliver high torque at low rpm, significantly reducing fuel consumption.

# ECOOPERATOR



# Made for the toughest working conditions

The Volvo L350F is designed to withstand even the toughest operating conditions such as face loading freshly blasted rock. All components, including engine, transmission, axles, frame and lifting arm mechanism, feature a robust design to make them last longer, keeping your uptime high and repair and maintenance costs low.

## Frame and central hinge

The high quality frame and central hinge is strong and reliable, providing stress resistance and operational stability. The upper and lower joints are designed to resist large forces and heavy loads for maximum durability and longevity.



## Transmission

The heavy-duty planetary transmission has generous contact points between meshing gears and is able to carry heavy loads and transmit large forces to move the L350F in all directions.



## Lifting arm system

The robust design on the Z-bar lifting arm can ensure a long machine life. All pins on the lift arm system are double-sealed to further extend the service life of the pins. Volvo offers one standard lift arm system that can be used for all applications such as lifting 50-ton blocks and working in tunnelling with a side-dump bucket.



## Axles

Fully floating heavy-duty axles carry the L350F. The cooling of the axle oil is achieved by circulating oil in each axle in two separated circuits. The oil is constantly circulated from the differential carrier assembly to each brake at the hub reduction when the engine is running. The oil from the axle passes through a hydraulic filter, leading to a long component service life.







An L350F worked on a quarry in Italy, transporting blocks of marble weighing up to 30 tons. Working 1300m (4265ft) above sea level, this machine ensured smooth and uninterrupted operations in challenging conditions.

### **L350F in action**



# Drive down your Total Cost of Ownership

## REPAIR AND MAINTENANCE

The L350F offers safe and effective maintenance access, including anti-slip plates, handrails and swing out mudguards.

## PRODUCTIVITY

Built to produce up to 14% more than its competitors, the L350F offers the perfect combination of power and balance for outstanding productivity.

## VOLVO ATTACHMENTS

A full range of Volvo attachments is available, designed to work in harmony with the machine and ensure the highest performance in every application.

## AVAILABILITY

The L350F has been built to maximize uptime, with a service and support network designed to enhance productivity.





## FUEL EFFICIENCY

The L350F powertrain delivers unrivalled fuel efficiency and performance, offering 10% lower fuel consumption than competitors.

## SAFETY

The L350F is equipped with outstanding safety features to ensure safe and comfortable operation in all applications.



## DURABILITY

Designed to perform in even the toughest applications, the L350F features robust components to keep uptime high and maintenance costs low.





# CARE TRACK

CareTrack is the state-of-the-art telematics system designed to work with a Volvo machine's own diagnostic system combined with GPS and mobile network or data via satellite. When CareTrack is activated on your machine, it allows you to remotely follow up machine utilization, productivity, get alarms and warnings, error codes, performance data download and also anti-theft functionality. CareTrack greatly increases your uptime.



# Adding value to your business

The L350F has been designed and tested to maximize your uptime. In addition to the availability achieved by the machine's innovative design, the L350F comes with a complete set of customer solutions to ensure this wheel loader is always ready to deliver. High availability means more productive uptime and a lower total cost of ownership.

## Service network

In order to respond to your needs faster, a Volvo expert is always available to visit your job site from one of our Volvo facilities. With our extensive infrastructure of technicians, workshops and dealers, Volvo has a comprehensive network to fully support you using local knowledge and global experience.



## Customer Support Agreement

Volvo Construction Equipment's range of Customer Support Agreements offers preventive maintenance, total repairs and a number of uptime services. Volvo uses the latest technology to monitor machine operation and status, giving you advice to increase your profitability. By having a Customer Support Agreement you are in control of your service costs.



## SiteSim

Volvo SiteSim is a unique tool that answers a variety of questions related to the equipment fleet and jobsite. It determines the optimal fleet for a new site, evaluates the performance of the current fleet or a combination of the two. It also considers various fleet options to determine the fleet addition required to maximize the output while keeping lowest total cost of ownership.



The L350F proved to be a valuable asset at a landfill site in the USA.

The L350F was monitored remotely as it carried out its daily duties – using CareTrack the machine owner was able to monitor his machine, reduce fuel consumption and increase productivity even when he was not at the site.

## L350F in action

# Access more uptime

Repair and maintenance costs can form up to 10% of the cost of owning and operating a wheel loader of this size class. With the Volvo L350F, you can enjoy significantly lower costs as the result of the durable components, long service intervals and service-centered design.

## Durable components

With genuine Volvo ground engaging tools, you can achieve up to 20% longer service life than competition, saving cost on wear parts and labor.



## Auto-lube (option)

All points on the machine which require greasing are automatically taken care of. This ensures proper maintenance for long pin and bearing lives and cuts down time spent on manual greasing.



## Easy coolant level check

An engine coolant inspection door forms part of the top engine access door. This can be opened without the need to swing out the fender for simplified access.





# SERVICEABILITY

Grouped service points combined with safe and easy access is in the core of the L350F design. In addition, the long service intervals offer more time for productive work. The outboard mounted wet disc service brakes are equipped with forced circulating oil cooling and a brake disc inspection pin on all brake housings increases safety and simplifies maintenance planning.



“ ”

As part of a fleet of 34 Volvo machines working at a marble mine in Turkey, an L350F proved that its durable components and easy serviceability made it the perfect addition to the team. The owner relied on the L350F to operate under high stress levels and in tough conditions, producing 170,000 tons of marble a year.

**L350F in action**

# VOLVO CARE CAB

The Volvo Care Cab is as good as it gets – space, outstanding visibility, ergonomics, a sophisticated heating and ventilation system with industry leading air filtration, low noise level, dampening to reduce whole body vibration and outstanding machine stability.



At a busy wharf in New Zealand, a team of two L350F machines worked round the clock to load and unload timber transported to and from the area. Operators at the site commented that the all-round visibility and ergonomic controls guaranteed a safe, comfortable ride at all times – even during a 12 hour shift.

**L350F in action**



# More comfort, more hours, more value

Safety is a core value at Volvo. Constantly improving safety is an integral part of the company's product development work, with the aim of reducing the risk of accidents and providing an outstanding working environment.

## Heavy-duty operator seat

A Volvo branded, heavy-duty, heated seat with air-suspension and high back (head rest) is available as standard. The new heavy duty seat offers high stability due to its sliding mechanism, offering more adjustment possibilities and improved body support.



## Remote door opener (option)

A new remote door opener is standard on the L350F. In addition to this, an electrical switch is located on the rear left cab post, allowing the operator to easily open the cab door.



## Increased fender-wheel clearance

The clearance between the rear fenders and tires is increased to allow the use of chains without potential interference of the chain with the fenders.



## Easy cab access

The entrance to the cab has been redesigned to cover the rear tire fenders. The steps are wide and ergonomically spaced for easy ingress and egress to and from the cab. New sturdy and well routed handrails further increase ease of access and safety.



## LED lights (option)

LED working lights offer a "daylight" type light spectrum for excellent visibility. Intensity doesn't fade over time.



## Cab entrance light (option)

LED light illuminates the cab entrance steps and areas around it for safe entry and exit to/from the operator station. The operator can activate the light by pressing the green button by the main switch. Better visibility in dark working conditions increases operator safety while climbing up to or down from the operator station.



# For extreme production environments

Wheel loaders of this size work around the clock loading trucks, rehandling, lifting blocks, stacking logs, and in other demanding applications. The L350F can be fitted with a range of Volvo attachments that ensure high reliability and a low total cost of ownership.

## L350F in rehandling

The Volvo Rehandling bucket and Boom Suspension System enhance productivity and comfort.



## L350F in block handling

The Volvo L350F can be equipped with a wide range of Volvo Block Handling attachments to ensure high lifting forces. Increased hydraulic pressure and robust rims ensure this machine gives a strong performance in all block handling applications.



## L350F in tunneling

Equipped with a Volvo Rock bucket or Side Dump bucket, the L350F is designed to ensure a durable, reliable performance and a high material extraction rate.



## L350F in logging

Logging demands heavy lifting and high breakout forces. The L350F logger comes with larger lift cylinders for increased lifting and breakout capacity. The logging counterweights and heavy-duty rims ensure machine stability. The electrohydraulic system, with third hydraulic function, allows for precise load control.





# L350F IN FACE LOADING

When fitted with a Volvo Rock bucket, the L350F is ideally sized to load trucks up to 64t (70t) in hard rock quarries. It is built to deliver outstanding maneuverability for enhanced productivity. When equipped with long boom configuration, this machine can load a 64t (70t) truck in under six passes.



“ ”

Working at one of the biggest wood production sites in Finland, L350F wheel loaders were used to help process over 100 trailers of timber a day. Featuring grab and grapple attachments for quick and easy log handling, these machines worked 24 hours a day in temperatures that often fell to  $-30^{\circ}\text{C}$ .

**L350F in action**

# Volvo L350F in detail

## Engine

**Engine:** V-ACT Stage III A/Tier 3, 16 liter, 6-cylinder in-line turbo-charged, air-to-air intercooler diesel engine with double rockers and Internal Exhaust Gas Recirculation (I-EGR). One-piece cylinder head with four valves per cylinder and one overhead camshaft. The engine has wet replaceable cylinder liners and replaceable valve guides and valve seats. Mechanically actuated electronically controlled unit injectors. The throttle application is transmitted electrically from the throttle pedal. **Air cleaning:** Three stage cyclone pre-cleaner - primary filter - secondary filter. **Cooling system:** Hydrostatic, electronically controlled fan and intercooler of the air-to-air type.

Engine	Volvo	Volvo D16E
Max power at	r/s / r/min	28.3-30.0 / 1 700-1 800
SAE J1995 gross	kW / hp	397 / 540
ISO 9249, SAE J1349 net	kW / hp	394 / 535
Max torque at	r/s / r/min	23.3 / 1 400
SAE J1995 gross	Nm	2 550
ISO 9249, SAE J1349 net	Nm	2 532
Economic working range	r/min	1 000-1 500
Displacement	l	16.1

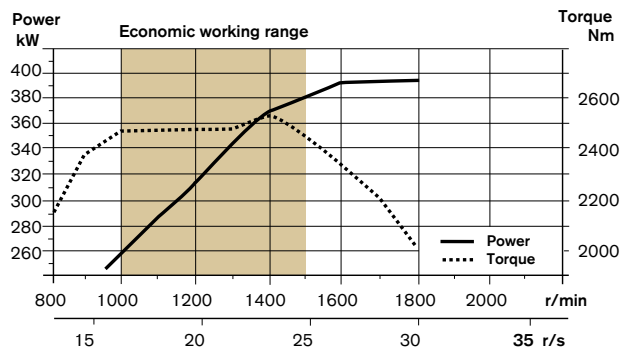

## Drivetrain

**Torque converter:** 3-element, 1-stage, 1-phase torque converter with Lock-Up function and free-wheel stator. **Transmission:** Planetary Power Shift transmission with full modulated electronically controlled shifting of 4 gears forward and reverse. Volvo Automatic Power Shift (APS) gear shifting system with fully automatic shifting 1-4 (Lock-Up in 3-4) and mode selector with 4 different gear shifting programs, including AUTO mode. **Axes:** Fully floating axle shafts with planetary-type heavy-duty hub reductions. Fixed front axle and oscillating rear axle. **Optional:** Limited Slip differentials in front and rear axle

Transmission	Volvo HTE 400
Torque multiplication, stall ratio	2.65
Maximum speed, forward/reverse	
1st gear	km/h 6.8 / 7.5
2nd gear	km/h 12.1 / 13.2
3rd gear	km/h 21.0 / 22.9
4th gear	km/h 35.7 / 38.2
Measured with tires	35/65 R33 L4
Front axle/rear axle	Volvo AHW 90/AHW 90
Rear axle oscillation	±12°
Ground clearance at 12° osc.	mm 550

## Electrical system

**Central warning system:** Contronic electrical system with central warning light and buzzer for following functions: - Serious engine malfunction - Low steering system pressure - Overspeed warning engine - Interruption in communication (computer error) Central warning light and buzzer with gear engaged for the following functions: - Low engine oil pressure - High engine oil temperature - High charge-air temperature - Low coolant level - High coolant temperature - High crankcase pressure - Low transmission oil pressure - High transmission oil temperature - Low brake pressure - Engaged parking brake - Brake charging failure - Low hydraulic oil level - High hydraulic oil temperature - Overspeeding in engaged gear - High brake cooling oil temperature front and rear axles.

Voltage	V	24
Batteries	V	2x12
Battery capacity	Ah	2x170
Cold cranking capacity, approx.	A	1 000
Reserve capacity	min	330
Alternator rating	W/A	2 280/80
Starter motor output	kW	7.0

## Brake system

**Service brake:** Service brakes are dual circuit all-hydraulic multi-disc brakes with nitrogen-charged accumulators and automatic slack adjusters. Outboard-mounted oil-cooled, wet disc brakes at each wheel. Transmission disengagement during braking can be preselected in Contronic. **Parking brake:** Wet multi-disc type in transmission housing. Spring-applied, electro-hydraulically released with a switch on instrument panel. Applies automatically when the key is turned off. **Secondary brake:** Dual circuit axle-by-axle system. Actuated by service brake pedal. Low pressure alarm. Dead engine braking capability provided by three nitrogen-charged accumulators. **Standard:** The brake system complies with the requirements of ISO 3450:1996.

Number of brake discs per wheel		11
Accumulators	l	6 x 1.0
Accumulators for parking brake	l	1 x 0.5

## Cab

**Instrumentation:** All important information is centrally located in the operator's field of vision. Display for Contronic monitoring system. Heater and defroster: Heater coil with filtered fresh air, fan with auto function and 11 manually selectable steps, defroster vents for all window areas. **Operator's seat:** Operator's seat with adjustable suspension and retractable seatbelt. The seat is mounted on a bracket on the rear wall and floor. The forces from the retractable seatbelt are absorbed by the seat rails. **Standard:** The cab is tested and approved according to ROPS (ISO 3471, SAE J1040), FOPS (ISO 3449). The cab meets with requirements according to ISO 6055 ("Operator overhead protection - Industrial trucks") and SAE J386 ("Operator Restraint System").

Sound level in cab according to ISO 6396 - LpA	dB(A)	72
External sound level according to ISO 6395 - LwA	dB(A)	111
Ventilation	m <sup>3</sup> /min	9
Heating capacity	kW	13
Air conditioning	kW	8



### Lift arm system

Z-bar linkage system with high breakout forces. The lift arms are single plate construction with a high-strength steel cast cross tube. The single bell crank and bucket link are nodular iron castings.

Lift cylinders		2
Cylinder bore	mm	200
Piston rod diameter	mm	110
Stroke	mm	1 264
Tilt cylinder		1
Cylinder bore	mm	260
Piston rod diameter	mm	120
Stroke	mm	728

### Hydraulic system

**System supply:** Two load-sensing axial piston pumps with variable displacement. The steering function always has priority from one of the pumps. **Valves:** Double-acting 2-spool valve. The main valve is controlled by an electric pilot. **Lift function:** The valve has four positions; lift, hold, lower, and float position. Inductive/magnetic automatic boom kickout can be switched on and off and is adjustable to any position between maximum reach and full lifting height. **Tilt function:** The valve has three functions; rollback, hold, and dump. Inductive/magnetic automatic bucket positioner can be switched on and off. **Cylinders:** Double-acting cylinders for all functions. **Filter:** Full-flow filtration through 20 micron (absolute) filter cartridge. Hydraulic oil cooler: Air-cooled oil cooler mounted on radiator.

Working pressure maximum, pump 1	MPa	25
Flow	l/min	256
at	MPa	10
engine speed	r/s / r/min	30 / 1 800
Working pressure maximum, pump 2	MPa	26
Flow	l/min	354
at	MPa	10
engine speed	r/s / r/min	30 / 1 800
Working pressure maximum, pump 3	MPa	26
Flow	l/min	84
at	MPa	10
engine speed	r/s / r/min	30 / 1 800

### Cycle times

Raise*	s	8.0
Tilt*	s	1.9
Lower, empty	s	4.7
Total cycle time	s	14.6

\* with load according to ISO 14397 and SAE J818

### Steering system

**Steering system:** Load-sensing hydrostatic articulated steering with an accumulator system and a non-pressurized tank. **System supply:** The steering system has priority feed from a load-sensing axial pump with variable displacement. **CDC:** Speed-dependent electro-hydraulic power steering system with closed center hydrostatic back-up and end-stroke damping.

Steering cylinders		2
Cylinder bore	mm	110
Rod diameter	mm	70
Stroke	mm	586
Working pressure	Mpa	26
Maximum flow	l/min	354
Maximum articulation	°	±37

### Service

**Service accessibility:** Large, easy-to-open service doors with gas struts. Swing-out radiator grill. Fluid filters and component breather filters promote long service intervals. Possibility to monitor, log, and analyze data to facilitate troubleshooting

### Refill capacities

Fuel tank (total)	l	660
Fuel, usable	l	620
Engine oil	l	40
Engine coolant	l	68
Transmission oil	l	79
Axle oil front/rear	l	155
Hydraulic oil tank	l	365

# Specifications

Tires: 35/65 R33 RL5K L5 Goodyear

		Standard boom	Long boom
B	mm	9 130	9 560
C	mm	4 300	-
D	mm	550	-
F	mm	4 180	-
F <sub>1</sub>	mm	3 980	-
F <sub>2</sub>	mm	3 220	-
G	mm	2 130	-
J	mm	4 920	5 400
K	mm	5 340	5 810
O	°	60	58
P <sub>max</sub>	°	46	-
R	°	43	45
R1*	°	49	50
S	°	66	72
T	mm	120	130
U	mm	660	770
V	mm	3 970	-
X	mm	2 720	-
Y	mm	3 630	-
Z	mm	4 230	4 650
a <sub>2</sub>	mm	8 240	-
a <sub>3</sub>	mm	4 610	-
a <sub>4</sub>	±°	±37	-

\* Carry position SAE

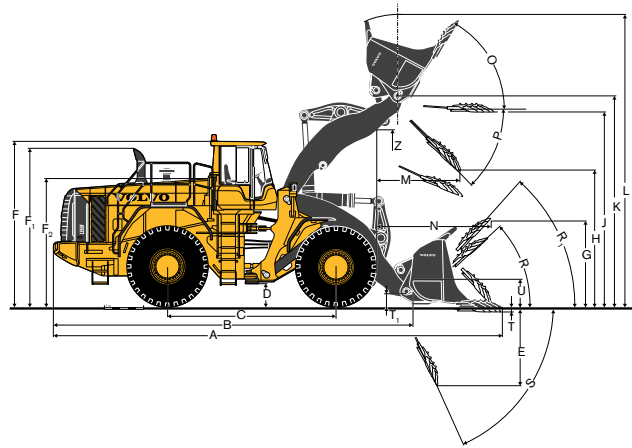

Where applicable, specifications and dimensions are according to ISO 7131, SAE J732, ISO 7546, SAE J742, ISO 14397, SAE J818.

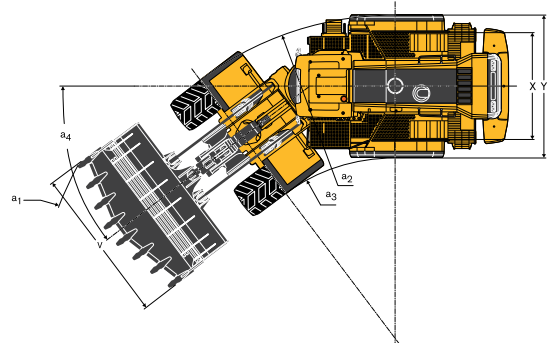

Type of boom	Type of bucket	ISO/SAE Bucket volume	L350F							
			0.8	1.0	1.2	1.4	1.6	1.8	2.0	
Standard boom	General purpose	8.4 m <sup>3</sup>								
	Rock	STE 6.9 m <sup>3</sup>								
		SPN 6.9 m <sup>3</sup> SPN 7.7 m <sup>3</sup>								
	Light mtrl	12.7 m <sup>3</sup>								
Side dump	SIT PT 6.4m <sup>3</sup>									
Long boom	General purpose	7.7 m <sup>3</sup>								
	Rock	STE 6.9 m <sup>3</sup>								
		SPN 6.5 m <sup>3</sup> SPN 6.9 m <sup>3</sup>								
	Light mtrl	12.7 m <sup>3</sup>								
Side dump	SIT PT 6.4m <sup>3</sup>									

Bucket fill  
110% 105% 100% 95%

How to read bucket fill factor

## Bucket Selection Chart

The volume handled varies with the bucket fill and is often greater than indicated by the bucket's ISO/SAE volume. The table shows optimum bucket choice with regard to the material density.











Material	Bucket fill, %	Material density, t/m <sup>3</sup>
Earth	110-115	1.4-1.6
Clay	110-120	1.4-1.6
Sand	100-110	1.6-1.9
Gravel	100-110	1.7-1.9
Rock	75-100	1.5-1.9

The size of rock buckets is optimized for optimal penetration and filling capability rather than the density of the material.

## Supplemental Operating Data











	Width over tires	Ground clearance	Operating weight	Static tipping load, full turn	
				Standard boom	Long boom
	mm	mm	kg	kg	kg
35/65 R33 XLD D1 L4 Michelin	10	-20	-1 140	-1 030	-910
35/65 R33 XLD D2 L5 Michelin	10	-20	-440	-580	-510
35/65 R33 X-Mine D2 L5 Michelin	20	-20	260	-50	-40



STANDARD BOOM		ROCK							GENERAL PURPOSE	LIGHT MATERIAL	SIDE DUMP ROCK	
Tires 875/65 R33 RL5K L5 GY Pin-on buckets												
		Teeth	Teeth & Segments	Bolt-on edges	Teeth	Teeth & Segments	Bolt-on edges	Teeth & Segments	Bolt-on edges	Bolt-on edges	Bolt-on edges	Teeth & Segments
Volume, heaped ISO/SAE	m <sup>3</sup>	6.6	6.9	6.9	6.8	6.9	6.9	7.7	7.7	8.4	12.7	6.4
Static tipping load, straight	kg	40 030	39 060	39 340	38 920	38 230	38 730	37 810	38 330	38 810	37 830	31 640
at 35°	kg	35 710	34 780	35 060	34 640	33 950	34 460	33 550	34 070	34 550	33 560	27 590
at full turn	kg	35 220	34 290	34 580	34 150	33 470	33 980	33 060	33 590	34 070	33 080	27 130
Breakout force	kN	504.7	472.8	474.8	392.6	372.3	373.9	356.8	358.3	419.1	376.4	348.8
A	mm	10 990	11 070	10 740	11 430	11 500	11 180	11 600	11 270	10 970	11 160	11 750
E	mm	1 620	1 670	1 390	2 000	2 050	1 770	2 130	1 850	1 590	1 760	2 270
H*)	mm	3 790	3 720	3 940	3 500	3 430	3 650	3 370	3 590	3 790	3 640	3 290
L	mm	7 460	7 460	7 460	7 430	7 430	7 430	7 550	7 550	7 280	7 730	7 210
M*)	mm	1 830	1 790	1 590	2 160	2 120	1 920	2 180	1 980	1 740	1 890	2 290
N*)	mm	2 730	2 680	2 530	2 980	2 920	2 790	2 960	2 830	2 640	2 700	3 030
V	mm	3 970	3 970	3 970	3 970	3 970	3 970	3 970	3 970	3 970	4 500	3 970
a, clearance circle	mm	18 090	18 100	17 960	18 310	18 320	18 170	18 370	18 210	18 060	18 650	18 450
Operating weight	kg	49 810	50 230	50 020	50 280	50 700	50 550	50 940	50 790	50 130	51 030	54 920

\*) Measured to the tip of the bucket teeth or bolt-on edge. Dump height to bucket edge.

Note: This only applies to genuine Volvo attachments. Measured at 45° dump angle. (Spade nose buckets at 42°)

LONG BOOM		ROCK							GENERAL PURPOSE	LIGHT MATERIAL	SIDE DUMP ROCK	
Tires 875/65 R33 RL5K L5 GY Pin-on buckets												
		Teeth	Teeth & Segments	Bolt-on edges	Teeth	Teeth & Segments	Bolt-on edges	Teeth & Segments	Bolt-on edges	Bolt-on edges	Bolt-on edges	Teeth & Segments
Volume, heaped ISO/SAE	m <sup>3</sup>	6.2	6.5	6.5	6.4	6.5	6.5	6.9	6.9	7.7	12.7	6.4
Static tipping load, straight	kg	37 810	36 950	37 220	36 860	36 210	36 670	35 960	36 420	36 810	35 590	27 080
at 35°	kg	33 620	32 800	33 070	32 700	32 050	32 520	31 810	32 280	32 660	31 450	23 440
at full turn	kg	33 150	32 320	32 600	32 230	31 580	32 050	31 340	31 810	32 180	30 980	23 030
Breakout force	kN	471.7	442.4	443.6	365.9	347.6	348.5	338.1	339.1	396.8	341.2	317.9
A	mm	11 370	11 430	11 110	11 790	11 860	11 540	11 920	11 600	11 300	11 580	12 160
E	mm	1 640	1 690	1 400	2 040	2 080	1 790	2 140	1 850	1 570	1 830	2 360
H*)	mm	4 290	4 220	4 440	4 010	3 940	4 160	3 900	4 120	4 310	4 130	3 760
L	mm	7 870	7 870	7 870	7 850	7 840	7 840	7 900	7 900	7 650	8 200	7 690
M*)	mm	1 800	1 770	1 560	2 120	2 090	1 890	2 130	1 930	1 690	1 910	2 300
N*)	mm	3 060	3 010	2 850	3 310	3 250	3 110	3 280	3 140	2 950	3 050	3 390
V	mm	3 970	3 970	3 970	3 970	3 970	3 970	3 970	3 970	3 970	4 500	3 970
a, clearance circle	mm	18 380	18 390	18 240	18 600	18 610	18 450	18 640	18 480	18 330	18 960	18 770
Operating weight	kg	51 320	51 740	51 530	51 790	52 210	52 060	52 330	52 180	51 580	52 660	55 160

\*) Measured to the tip of the bucket teeth or bolt-on edge. Dump height to bucket edge.

Note: This only applies to genuine Volvo attachments. Measured at 45° dump angle. (Spade nose buckets at 42°)

# Equipment

## STANDARD EQUIPMENT

### Service and maintenance

Engine oil remote drain and fill  
Transmission oil remote drain and fill  
Grouped lubrication points, ground accessible  
Pressure check connections: transmission and hydraulic, quick-connect, grouped on console for easy access  
Tool box, lockable  
Wheel nut wrench kit

### Engine

Three stage air cleaner, pre-cleaner, primary and secondary filter  
Indicator glass for coolant level  
Preheating of induction air  
Fuel pre-filter with water trap  
Fuel filter  
Crankcase breather oil trap

### Electrical system

24 V, pre-wired for optional accessories  
Alternator 24V/ 80A  
Battery disconnect switch with removable key  
Fuel gauge  
Hour meter  
Electric horn  
Instrument cluster:  
Fuel level  
Transmission temperature  
Coolant temperature  
Instrument lighting  
Reverse alarm  
Lighting:  
Twin halogen front headlights with high and low beams  
Parking lights  
Double brake and tail lights  
Turn signals with flashing hazard light function  
Halogen work lights (4 front and 4 rear)

### Conronic monitoring system

Monitoring and logging of machine data  
Conronic display  
Fuel consumption  
Ambient temperature  
Clock  
Brake test  
Test function for warning and indicator lights  
Warning and indicator lights:  
Battery charging  
Parking brake  
Warning and display message:  
Engine coolant temperature  
Charge-air temperature  
Engine oil temperature  
Engine oil pressure  
Transmission oil temperature  
Transmission oil pressure  
Hydraulic oil temperature  
Brake pressure  
Parking brake applied  
Parking brake NOT applied  
Brake charging  
Overspeed at direction change  
Axle oil temperature  
Steering pressure  
Crankcase pressure  
Attachment lock open  
Level warnings:  
Fuel level  
Engine oil level  
Engine coolant level  
Transmission oil level  
Hydraulic oil level  
Washer fluid level  
Engine torque reduction in case of malfunction indication:  
High engine coolant temperature  
High engine oil temperature  
Low engine oil pressure  
High crankcase pressure  
High charge-air temperature  
Engine shutdown to idle in case of malfunction indication:  
High transmission oil temperature  
Slip in transmission clutches  
Keypad, background lit  
Start interlock when gear is engaged

### Drivetrain

Automatic Power Shift (APS) with operator controlled transmission disengagement when braking and mode selector with AUTO mode  
Fully automatic gear shifting, 1-4  
Pulse Width Modulation (PWM) controlled gear shifting  
Torque converter with Lock-Up  
Automatic Lock-Up shifting, 3-4 (gear selector in 4) and 2 (gear selector in 2)  
Forward and reverse switch by hydraulic lever console  
Indicator glass for transmission oil level

### Brake system

Wet oil circulation-cooled disc brakes on all four wheels  
Dual brake circuits  
Dual brake pedals  
Secondary brake system  
Parking brake, electric-hydraulic  
Brake wear indicators

### Cab

ROPS (ISO 3471), FOPS (ISO 3449)  
Acoustic inner lining  
Ashtray  
Cigarette lighter, 24 V power outlet  
Lockable door  
Cab heating with fresh air inlet and defroster  
Fresh air inlet with two filters  
Automatic climate control (ACC)  
Floor mat  
Dual interior lights  
Dual interior rear-view mirrors  
Dual exterior rear-view mirrors  
Sliding window, right side  
Tinted safety glass  
Operator's seat, KAB, air-suspended, heavy-duty  
Lap-type retractable seatbelt (SAE J386)  
Ergonomic heavy-duty operator's seat with adjustable position and suspension  
Seat-mounted adjustable lever console, working hydraulics  
Adjustable steering wheel  
Storage compartment  
Document pocket  
Sun visor  
Beverage holder  
Windshield washer front and rear  
Windshield wipers front and rear  
Interval function for front and rear wipers  
Service platforms with slip protected surfaces on front and rear fenders  
Comfort Drive Control (CDC)

### Hydraulic system

Main valve, double-acting 2-spool with electric pilots  
Variable displacement axial piston pumps (3) for:  
Steering system, working hydraulics  
Working hydraulics, brakes  
Cooling fan, brakes  
Electric-hydraulic servo control  
Electric level lock  
Boom kick-out, automatic, adjustable from cab  
Return-to-dig, automatic, adjustable from cab  
Bucket positioner, automatic, adjustable from cab  
Double-acting hydraulic cylinders with end-damping  
Indicator glass for hydraulic oil level  
Hydraulic oil cooler

### External equipment

Fenders, front with rubber extensions  
Viscous cab mounts  
Rubber engine and transmission mounts  
Lifting eyes  
Easy-to-open side panels with gas struts  
Frame, joint lock  
Vandalism lock prepared for  
Batteries  
Engine compartment  
Radiator  
Tie-down eyes  
Recovery eyes  
Tow hitch

## OPTIONAL EQUIPMENT

### Service and maintenance

Tool kit  
Automatic lubrication system  
Automatic lubrication system for long boom  
Refill pump for automatic lubrication system  
Oil sampling valve

### Engine

Air pre-cleaner, oil-bath type  
Air pre-cleaner, cyclone type  
Cooling package: Radiator and charge air cooler, corrosion-protected  
Engine block heater, 230 V  
Engine auto shutdown  
ESW, increased engine protection  
ESW, disabled engine protection  
Hand throttle control  
Fuel fill strainer  
Fast fill fuel system  
Fuel heater  
Reversible cooling fan  
Max. fan speed, hot climate



## OPTIONAL EQUIPMENT

### Electrical system

Alternator, 80 A with air filter  
Alternator, 110 A

Battery, high capacity  
Anti-theft device

Work lights front, high intensity discharge (HID)

Work lights front, on cab, dual

Work lights rear, on cab

Work lights rear, on cab, dual

Warning beacon, rotating

### Cab

Radio with CD player

Radio installation kit incl. 11 A, 12 V outlet, left side

Radio installation kit incl. 11 A, 12 V outlet, right side

Rear-view camera incl. monitor, colour

Rear-view mirrors, electrically adjustable and heated

Asbestos dust protection filter

Carbon filter

Automatic climate control panel, with Fahrenheit scale

Lunchbox holder

Seatbelt, 3", (width 75 mm)

Steering wheel knob

Sun blind, rear window

Sun blind, side windows

Timer cab heating

Window sliding, door

Universal door/ignition key

Anchorage for Operator's manual

### Drivetrain

Limited Slip differential, rear axle

Limited Slip differential, front and rear axle

Speed limiter, 20 km/h

Speed limiter, 30 km/h

### Brake system

Oil coolers for front and rear axles

### Hydraulic system

Boom suspension system with single-acting lift function

Arctic kit, pilot hoses, brake accumulators and hydraulic oil

3rd electro-hydraulic function

3rd electro-hydraulic function for long boom

Hydraulic oil cooler, corrosion-protected

Hydraulic attachment bracket

Separate attachment locking

Biodegradable hydraulic fluid

Fire-resistant hydraulic fluid

Hot climate hydraulic fluid

### External equipment

Long boom

### Protective equipment

Guards for front headlights

Guards for tail lights

Guards for tail lights, heavy-duty

Guards for rear work lights

Guards for radiator grill

Windows, side and rear guards

Windshield guard

Belly guard, front

Belly guard, rear

Mudguards fixed front and swing out rear, mudguards wideners incl.

### Other equipment

Secondary steering with automatic test function

Logger version

Block handler kit

Block handler kit, heavy-duty

CE-marking

Sound decal, EU

CareTrack, GSM (Europe and North America)

CareTrack, GSM/Satellite (Europe and North America)

### Tires and Rims

35/65 R33 (875/65 R33):

L4

L5

Rims, 33-28.00/3.5:

Five piece

Five piece, wood protected

Five piece, heavy-duty

### Attachments

Buckets (pin-on):

Rock, straight edge

Rock, spade nose

Rock, side-dump, spade nose

General purpose, straight edge

Light material

Wear parts:

Adapters for teeth, weld-on

Teeth

Segments, bolt-on

Edge savers, bolt-on

Block handling equipment (hook-on):

Rock bucket

Stone fork

Breaker tine

Rake

Log grapples

## SELECTION OF VOLVO OPTIONAL EQUIPMENT

### Boom suspension system



### Cab entrance light



### LED lights



### Central lubrication



### Axle oil cooler



### Oil bath pre-cleaner



Not all products are available in all markets. Under our policy of continuous improvement, we reserve the right to change specifications and design without prior notice. The illustrations do not necessarily show the standard version of the machine.

**VOLVO**

**Volvo Construction Equipment**

[www.volvoce.com](http://www.volvoce.com)