



Volvo Construction Equipment

L150H, L180H, L220H

VOLVO WHEEL LOADERS 23.0-35.5 t (50,700-77,800 lb) 295-366 hp



A passion for performance.

At Volvo Construction Equipment, we're not just coming along for the ride. Developing products and services that raise productivity – we are confident we can lower costs and increase profits for customers around the globe. Part of the Volvo Group, we are passionate about innovative solutions to help you work smarter – not harder.

Helping you to do more

Doing more with less is a trademark of Volvo Construction Equipment. High productivity has long been married to low energy consumption, ease of use and durability. When it comes to lowering life-cycle costs, Volvo is in a class of its own.

Designed to fit your needs

There is a lot riding on creating solutions that are suited to the particular needs of different industry applications. Innovation often involves high technology – but it doesn't always have to. Some of our best ideas have been simple, based on a clear and deep understanding of our customers' working lives.



You learn a lot in 180 years

Over the years, Volvo has advanced solutions that have revolutionized the use of construction equipment. No other name speaks Safety louder than Volvo. Protecting operators, those around them and minimizing our environmental impact are traditional values that continue to shape our product design philosophy.

We're on your side

We back the Volvo brand with the best people. Volvo is truly a global enterprise, one that is on standby to support customers quickly and efficiently – wherever they are.

We have a passion for performance.

A strong, dedicated, capable dealer network.

Our dealers are strategically located throughout North America to provide the equipment you need and the parts and service support you demand for a productive and profitable operation.

The strength of our dealer network is enhanced with extensive individualized product and product support training at our state-of-the-art Technical Training Center in Asheville and through hands-on training. At our nearby 80-acre Product Demonstration Center, visitors operate equipment from our entire product line under a variety of simulated working conditions. Both facilities are in year-round use by our dealers and customers – more than 2,000 visit each year.

Building the best starts right here.

The products designed and manufactured by Volvo Construction Equipment have their beginnings at the most advanced Research & Design centers in the industry. Volvo CE machines are designed in 11 R&D centers and produced in 15 manufacturing facilities across the world.

The major R&D center and manufacturing plant in the Americas is located in Shippensburg, Pennsylvania. This facility has been in operation for over 30 years and – with its recently added 200,000 sq. ft. expansion – now covers 570,000 sq. ft. on an 80 acre campus. Dedicated work teams and highly advanced technologies and techniques using the Volvo Production System ensure continuous quality improvements, labor savings and cost control to reach the high quality that our customers have come to expect from Volvo.





Volvo Trucks



Renault Trucks



Mack Trucks



UD Trucks



Volvo Buses



Volvo Construction Equipment



Volvo Penta



Volvo Financial Services



OptiShift

Volvo's OptiShift technology combines the company's patented Reverse By Braking (RBB) technology and a torque converter with lock-up. Lock-up creates a direct drive between the engine and transmission – eliminating power losses in the torque converter and reducing fuel consumption by up to 18%.

Innovative fuel efficiency.

Since Volvo Construction Equipment began designing wheel loaders in 1954, machine owners and operators have got to know the legendary reputation of these productive, fuel efficient machines. The new H-Series wheel loaders feature state-of-the-art technology such as OptiShift – a unique technical advancement which reduces fuel consumption by up to 18% and increases machine performance.

Reverse By Braking (RBB)

The Volvo patented RBB function senses the loader's direction and slows the machine down by automatically applying the brakes when the operator changes direction between forward and reverse or the other way around. This increases fuel efficiency and improves operator comfort. RBB is ideal for short cycle or truck loading applications.

Intelligent hydraulics

Volvo's load-sensing hydraulics supply power to the hydraulic functions on demand, lowering fuel consumption. The powerful system ensures fast response for shorter cycle times while delivering smooth operation through superior control of the load.



Eco pedal

Volvo's unique eco pedal applies mechanical push-back force when the accelerator is used excessively and engine rpm is about to exceed the economic operating range. This encourages the operator to ease off the throttle, reducing fuel consumption.

APS/FAPS

Automatic Power Shift (APS) and Fully Automatic Power Shift (FAPS) ensure optimal operation by adjusting the machine gears in line with parameters including engine and travel speed. This delivers fast cycle times and low fuel consumption. With APS the operator manually shifts down to first gear when more power is needed but with FAPS it's automatic.

Comfort boosts productivity.

At Volvo we know that when operators are comfortable they experience less fatigue and work more productively. That's why Volvo's industry-leading cab has been designed with the operator in focus – providing a spacious, safe and quiet environment that's perfect for optimizing productivity all day long.

Information panel

The display clearly presents the operator with vital machine information including fuel and oil levels and warning messages – ensuring optimal operation. From the operator seat, basic configurations and tests can be performed via the panel – which is easy-to-read even in bright sunlight.

Cab air filter

The cab air intake is located high on the machine, where air is cleanest. The easy-to-replace pre-filter separates coarser dust and particles before the air passes through the main filter and finally enters the cab. Volvo's industry-leading design allows 90% of the cab air to be recirculated through the main filter for continuous dust removal.



Single lever control

For ease of operation, the optional, multi-functional joystick gives the operator simultaneous and precise control of the hydraulic functions.



Volvo cab

The spacious ROPS/FOPS certified cab provides a comfortable operating environment with ergonomically placed controls and ample storage space. With low internal noise levels and vibration protection, operators will experience a productive work shift.



TP Linkage

Volvo's unique Torque Parallel (TP) linkage delivers high breakout torque and excellent parallel movement throughout the entire lifting range.

Loaded with productivity.

Maximize your productivity and access more applications when you combine the new L150H, L180H and L220H with Volvo's durable attachments. Whether you're working in the rehandling, extraction, block-handling, recycling or any other application, these machines will effectively perform a variety of tasks and increase your productivity.

Boom Suspension System

The optional Boom Suspension System (BSS)/ride control boosts productivity by up to 20% by absorbing shock and reducing the bouncing and bucket spillage that occurs when operating on rough ground. This enables faster and more comfortable work cycles and increases machine life.

Rehandling Bucket

With its optimized shape, the Volvo-designed rehandling bucket has been built to give faster and more efficient bucket fill – leading to up to 10% better fuel efficiency. The bucket features a spill guard, side cutters in line with the bucket sides, a wear plate designed for longer service life and fewer pockets which could trap material.

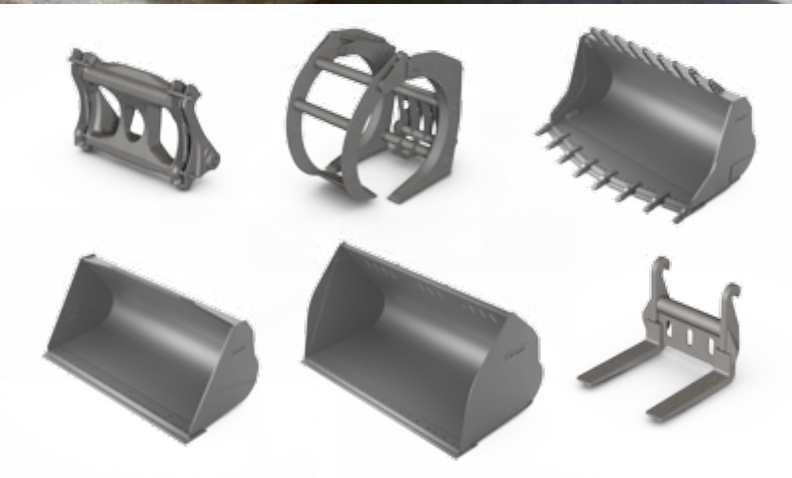

Volvo attachments

Volvo's durable attachments have been purpose-built to work in perfect harmony with Volvo machines and increase your productivity. The attachments are designed as an integrated part of the wheel loader with functions and properties ideally matched to parameters including link-arm geometry and breakout, rim pull and lifting force.

Special application options

With a wide variety of options, Volvo customers can adapt their machine to access more applications such as block handling, rock, quarry and waste handling etc.

Revolutionary reliability.

Featuring a premium Volvo Tier 4 Final/Stage IV engine and perfectly matched drivetrain and hydraulics, the L150H, L180H and L220H wheel loaders deliver power, productivity and reliability. Experience Volvo's proven, advanced technology and benefit from ultimate quality and durability.

Volvo engine

Featuring advanced technology and built on decades of experience, the powerful Volvo Tier 4 Final/Stage IV engine delivers high performance and low fuel consumption. During the fully automatic regeneration process, particulate matter collected in the DPF is burnt off without interrupting operation, performance or productivity.



Reversible cooling fan

The hydraulically-driven, electronically controlled cooling fan regulates the temperature of the vital components. It automatically increases the revs only when needed – reducing fuel consumption and noise. The reversible functionality blows air in the opposite direction – allows for self-cleaning of the cooling units.



Axle oil cooling

Both the front and the rear axle feature an axle oil circulation feature which allows the axle oil to circulate for better cooling.



Powertrain

The ideally-matched, all-Volvo powertrain has been built to work together in perfect harmony. The Volvo design has been rigorously tested to deliver optimized performance, high productivity, low fuel consumption and superior reliability.



Tilting cab

The cab can be tilted in two positions – 35° and 70°. Tilting the cab greatly improves service and maintenance access which leads to more uptime and increased machine availability. The cab is tilted via a manually operated pump.

Easy access = more uptime.

Taking care of your wheel loader shouldn't be complicated. That's why the L150H, L180H and the L220H are loaded with time saving features. One example of this is the new tilting cab which significantly improves service and maintenance access to help you work for longer and sustain productivity day in and day out.

Maintenance-free batteries

Two heavy-duty, maintenance-free 12V batteries in series provide a 24V electrical system. The batteries are located in a well-sealed compartment on the right side of the machine.

Lubrication system

The optional, automatic lubrication system controls greasing when the machine is in operation, resulting in more uptime and reduced maintenance. The operator can alter the amount of grease needed to suit the application.

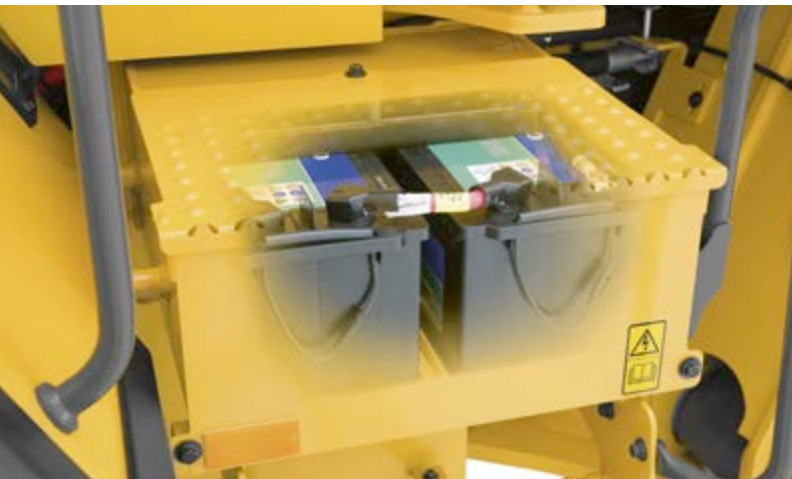

Maintenance-free rear axle cradles/trunnions

The rear axle is supported on maintenance-free cradles and includes lubricated for life bearings and bushings – reducing overall service cost, increasing machine uptime and ensuring long life.

Engine access

Electrically activated, the wide-opening engine hood allows quick and easy service access to the engine and components for maximum uptime.



Tilting cab

The cab can be tilted in two positions – 35° and 70° – for improved service and maintenance access. This leads to more uptime and increased machine availability.

Single lever

The optional, multi-functional joystick gives the operator simultaneous and precise control of the linkage.

Boom Suspension System (BSS)/Ride Control

The BSS boosts productivity by up to 20% by absorbing shock and reducing the bouncing and bucket spillage that occurs when operating at speed on rough terrain.



TP linkage

Volvo's unique Torque Parallel (TP) linkage delivers high breakout torque and excellent parallel movement through the entire lifting range.



OptiShift

Volvo's OptiShift technology reduces fuel consumption by up to 18%, increases operator comfort and reduces stress in the drivetrain.

Attachments

Volvo's durable attachments have been purpose-built to deliver maximum productivity and long service life in combination with Volvo machines.





Volvo cab

Volvo's industry-leading, certified ROPS/FOPS cab features ergonomically placed controls, low internal noise levels, vibration protection and ample storage space.

Diesel Exhaust Fluid (DEF)

Volvo offers a total DEF solution that is quality assured, cost efficient and easily accessible. Contact your Volvo dealer for more information.

Easy service access

Electrically activated, wide-opening engine hood allows quick and easy service access to the engine compartment.

Volvo engine

Volvo's Tier 4 Final/Stage IV engine delivers high performance at low rpm which improves fuel consumption. Regeneration is automatic and is done without interrupting operation, performance or productivity.



Powertrain

The ideally-matched, all-Volvo powertrain has been built to work together in perfect balance – ensuring optimized performance.

Intelligent hydraulics

Volvo's load-sensing hydraulics supply power to the hydraulic functions according to demand, lowering fuel consumption.

FAPS

Fully Automatic Power Shift (FAPS) ensure optimal operation by adjusting the machines gear shifting automatically.

Adding value to your business.

Being a Volvo customer means having a complete set of services at your fingertips. Volvo can offer you a long-term partnership, protect your revenue and provide a full range of customer solutions using high quality parts, delivered by passionate people. Volvo is committed to increasing the positive return on your investment and maximizing uptime.



Complete Solutions

Volvo has the right solution for you. So why not let us provide all your needs throughout the whole life cycle of your

machine? By listening to your requirements, we can reduce your total cost of ownership and increase your revenue.



Genuine Volvo Parts

Our attention to detail is what makes us stand out. This proven concept acts as a solid investment in your machine's future. Parts are extensively tested and approved because every part is vital for uptime and performance. Only by using Genuine Volvo Parts, can you be sure that your machine retains the renowned Volvo quality.



Service Network

In order to respond to your needs faster, a Volvo expert is on their way to your job site from one of our Volvo facilities. With our extensive infrastructure of technicians, workshops and dealers, Volvo has a comprehensive network to fully support you using local knowledge and global experience.



SERVICE PLAN

	DAY01	DAY02	DAY03	DAY04	DAY05	DAY06	DAY07
Task 1						✓	
Task 2				✓	✓		
Task 3	✓					✓	✓
Task 4			✓				
Task 5	✓						✓
Task 6			✓				
Task 7							✓

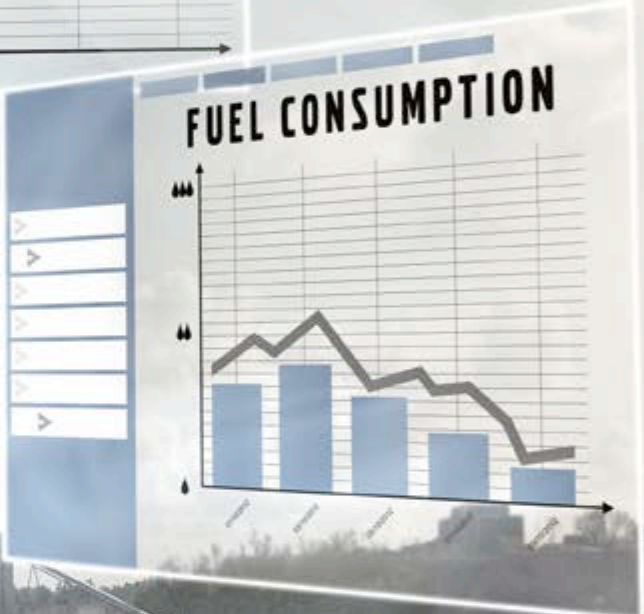

Customer Support Agreements

The range of Customer Support Agreements offer preventive maintenance, total repairs and a number of uptime services. Volvo uses the latest technology to monitor machine operation and status, giving you advice to increase your profitability. By having a Customer Support Agreement you are in control of your service costs.

Volvo L150H, L180H, L220H in detail.

Engine

V-ACT Stage IV/Tier 4F 13 liter, 6-cylinder straight turbocharged diesel engine with 4 valves per cylinder, overhead camshaft and electronically controlled unit injectors. The engine has wet replaceable cylinder liners and replaceable valve guides and valve seats. The throttle applications is transmitted electrically from the throttle pedal or the optional hand throttle.

Air Cleaning: 2 stages

Cooling system: Hydrostatic, electronically controlled fan and intercooler of the air-to-air type.

L150H

Engine	D13J (Tier 4f)		
Max power at	r/s (r/min)	21.7 (1,300)	
SAE J1995 gross	kW / hp	220 / 295	
ISO 9249, SAE J1349 net	kW / hp	220 / 295	
Max torque at	r/s (r/min)	16.7 (1,000)	
SAE J1995 gross	Nm lb ft	1 960	1,446
ISO 9249, SAE J1349	Nm lb ft	1 957	1,443
Economic working range	r/min	13.3-26.6 (800-1,600)	
Displacement	l gal	12.8	3.4

L180H

Engine	D13J (Tier 4f)		
Max power at	r/s (r/min)	21.7-23.3 (1,300-1,400)	
SAE J1995 gross	kW / hp	246 / 330	
ISO 9249, SAE J1349 net	kW / hp	245 / 329	
Max torque at	r/s (r/min)	16.7 (1,000)	
SAE J1995 gross	Nm lb ft	2 030	1,497
ISO 9249, SAE J1349 net	Nm lb ft	2 024	1,493
Economic working range	r/min	13.3-26.6 (800-1,600)	
Displacement	l gal	12.8	3.4

L220H

Engine	D13J (Tier 4f)		
Max power at	r/s (r/min)	21.7-23.3 (1,300-1,400)	
SAE J1995 gross	kW / hp	274 / 368	
ISO 9249, SAE J1349 net	kW / hp	273 / 366	
Max torque at	r/s (r/min)	18.3 (1,100)	
SAE J1995 gross	Nm lb ft	2 231	1,646
ISO 9249, SAE J1349 net	Nm lb ft	2 220	1,637
Economic working range	r/min	13.3-26.6 (800-1,600)	
Displacement	l gal	12.8	3.4

L150H

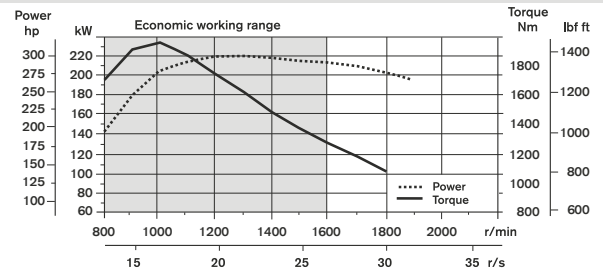

L180H

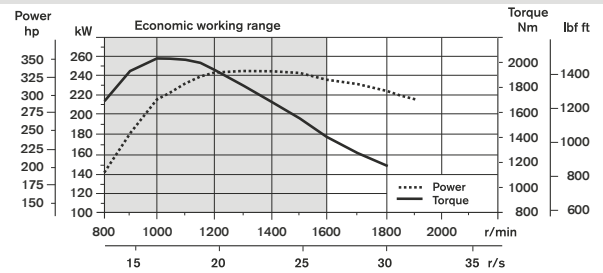

L220H

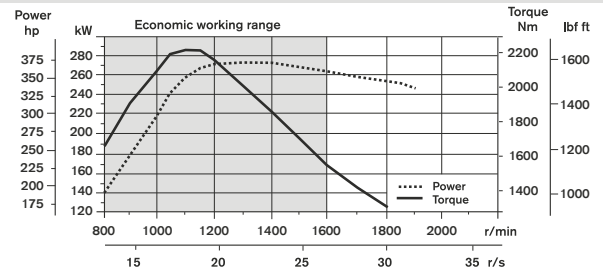

Drivetrain

Torque converter: Single-stage with Lock-Up.

Transmission: Volvo countershaft transmission. Fast and smooth shifting of gears with Pulse Width Modulation (PWM) valve. Torque converter with lockup.

Transmission: Volvo Automatic Power Shift (APS) with fully automatic shifting 1-4 and mode selector with 4 different gear shifting programs.

Axles: Volvo fully floating axle shafts with planetary hub reductions and nodular iron axle housing. Fixed front axle and oscillating rear axle. STD 100% differential lock available when needed on the front axle. Optional: Lim. slip rear

L150H

Transmission	Volvo HTL 222C			
	1st gear	km/h	mph	
				6,5 4.0
Maximum speed, forward/reverse	2nd gear	km/h	mph	12,5 7.8
	3rd gear	km/h	mph	26,0 16.2
	4th gear	km/h	mph	38,0 23.6
Measured with tires	26.5 R25 L3			
Front axle/rear axle	Volvo/AWB 40B/40C			
Rear axle oscillation ±				° 15
Ground clearance at 15° osc.	mm	in	610	24

L180H

Transmission	Volvo HTL 222C			
	1st gear	km/h	mph	
				6,5 4.0
Maximum speed, forward/reverse	2nd gear	km/h	mph	12,5 7.8
	3rd gear	km/h	mph	26,0 16.2
	4th gear	km/h	mph	38,0 23.6
Measured with tires	26.5 R25 L3			
Front axle/rear axle	Volvo/AWB 40B/40B			
Rear axle oscillation ±				° 15
Ground clearance at 15° osc.	mm	in	610	24

L220H

Transmission	Volvo HTL 307B			
	1st gear	km/h	mph	
				7,0 4.3
Maximum speed, forward/reverse	2nd gear	km/h	mph	12,5 7.8
	3rd gear	km/h	mph	25,0 15.5
	4th gear	km/h	mph	38,0 23.6
Measured with tires	29.5 R25 L4			
Front axle/rear axle	Volvo/AWB 50/41			
Rear axle oscillation ±				° 15
Ground clearance at 15° osc.	mm	in	600	23.6

Electrical system

Central warning system: Contronic system including central warning light and buzzer for following functions: - Serious engine fault - Low steering system pressure - Over speed warning engine - Interruption in communication (computer fault) Central warning light and buzzer with the gear engaged for the following functions: - Low engine oil pressure - High engine oil temperature - High charge air temperature - Low coolant level - High coolant temperature - High crank case pressure - Low transmission oil pressure - High transmission oil temperature - Low brake pressure - Engaged parking brake - Fault on brake charging - Low hydraulic oil level - High hydraulic oil temperature - Overspeeding in engaged gear - High brake cooling oil temperature front and rear axles.

Voltage	V	24
Batteries	V	2 x 12
Battery capacity	Ah	2 x 170
Cold cranking capacity, approx.	A	1 000
Batteries	connected to positive terminal	
Alternator rating	W/A	2 280/80
Starter motor output	kW	7

Brake system

Service brake: Volvo dual-circuit system with nitrogen charged accumulators. Outboard mounted hydraulically operated, fully sealed oil circulation-cooled wet disc brakes. The operator can select automatic disengagement of the transmission when braking using Contronic.

Parking brake: Fully sealed, wet multi-disc brake built into the transmission. Applied by spring force and electro-hydraulically released with a switch on the instrument panel.

Secondary brake: Dual brake circuits with rechargeable accumulators. One circuit or the parking brake fulfills all safety requirements.

Standard: The brake system complies with the requirements of ISO 3450.

L150H

Number of brake discs per wheel front/rear	1/1		
Accumulators	l	2 x 1.0	3 x 0.5

L180H

Number of brake discs per wheel front/rear	1/1		
Accumulators	l	2 x 1.0	1 x 0.5

L220H

Number of brake discs per wheel front/rear	2/1		
Accumulators	l	2 x 1.0	1 x 0.5

Cab

Instrumentation: All important information is visible in the monitoring system display in the operator's field of vision.

Heater and defroster: Heater coil with filtered fresh air and fan with auto and 11 speeds. Defroster vents for all window areas.

Operator's seat: Operator's seat with adjustable suspension and retractable seat belt. The seat is mounted on a bracket on the rear cab wall and floor. The forces from the retractable seat belt are absorbed by the seat rails.

Standard: The cab is tested and approved according to ROPS (ISO 3471), FOPS (ISO 3449). The cab meets with requirements according to ISO 6055 (Operator overhead protection - Industrial trucks) and SAE J386 ("Operator Restraint System").

L150H

Emergency exit:	Use emergency hammer to break window			
Sound level in cab according to ISO 6396/SAE J2105				
LpA	dB(A)			69
External sound level according to ISO 6395/SAE J2104				
LwA	dB(A)			108
Ventilation	m³/min	yd³/min	9	11.8
Heating capacity	kW			16
Air conditioning (optional)	kW			7.5

L180H

Emergency exit:	Use emergency hammer to break window			
Sound level in cab according to ISO 6396/SAE J2105				
LpA	dB(A)			70
External sound level according to ISO 6395/SAE J2104				
LwA	dB(A)			108
Ventilation	m³/min	yd³/min	9	11.8
Heating capacity	kW			16
Air conditioning (optional)	kW			7.5

L220H

Emergency exit:	Use emergency hammer to break window			
Sound level in cab according to ISO 6396/SAE J2105				
LpA	dB(A)			70
External sound level according to ISO 6395/SAE J2104				
LwA	dB(A)			109
Ventilation	m³/min	yd³/min	9	11.8
Heating capacity	kW			16
Air conditioning (optional)	kW			7.5

Volvo L150H, L180H, L220H in detail.

Lift arm system

Torque Parallel linkage (TP-linkage) with high breakout torque and parallel action throughout the entire lifting range.

		L150H		L180H		L220H	
Lift cylinders		2		2		2	
Cylinder bore	mm in	160 6.3	180 7.1	190 7.5			
Piston rod diameter	mm in	90 3.5	90 3.5	90 3.5			
Stroke	mm in	784 30.9	788 31.0	768 30.2			
Tilt cylinder		1		1		1	
Cylinder bore	mm in	220 8.7	240 9.4	250 9.8			
Piston rod diameter	mm in	110 4.3	120 4.7	120 4.7			
Stroke	mm in	452 17.8	480 18.9	455 17.9			

Hydraulic system

System supply: Two load-sensing axial piston pumps with variable displacement. The steering function always has priority.

Valves: Double-acting 2-spool valve. The main valve is controlled by pilot pressure and electric servo (L150H) i.e. by a 2-spool pilot valve (L180H/L220H).

Lift function: The valve has three positions: raise, hold and lower position. Inductive/magnetic automatic boom kick-out can be switched on and off and is adjustable by the operator in cab to any position between maximum reach and full lifting height.

Tilt function: The valve has three functions including rollback, hold and dump. Inductive/magnetic automatic tilt can be adjusted in cab to the desired bucket angle.

Cylinders: Double-acting cylinders for all functions.

Filter: Full flow filtration through 10 micron (absolute) filter cartridge.

		L150H		L180H		L220H	
Working pressure maximum, pump 1	MPa bar	29 290	29 290	29 290			
Flow at engine speed	l/min gal/min r/s (r/min)	180 47.5 32 (1,900)	217 57.3 32 (1,900)	252 66.8 32 (1,900)			
Working pressure maximum, pump 2	MPa bar	31 310	31 310	31 310			
Flow at engine speed	l/min gal/min r/s (r/min)	202 53.4 32 (1,900)	202 53.4 32 (1,900)	202 53.4 32 (1,900)			
Working pressure maximum, pump 3	MPa bar	25 250	25 250	25 250			
Flow at engine speed	l/min gal/min r/s (r/min)	77 20.3 32 (1,900)	77 20.3 32 (1,900)	77 20.3 32 (1,900)			
Pilot system, working pressure	MPa bar	3.5 35	3.5 35	3.5 35			
Cycle times							
Lift	s	5.9		6.4		6.8	
Tilt	s	2		1.8		1.6	
Lower, empty	s	3.7		3.3		3.2	
Total cycle time	s	11.6		11.5		10.6	

Steering system

Steering system: Load-sensing hydrostatic articulated steering.

System supply: The steering system has priority feed from a load-sensing axial piston pump with variable displacement.

Steering cylinders: Two double-acting cylinders.

		L150H		L180H		L220H	
Steering cylinders		2		2		2	
Cylinder bore	mm in	100 3.9	100 3.9	100 3.9			
Rod diameter	mm in	60 2.4	60 2.4	60 2.4			
Stroke	mm in	390 15.4	525 20.7	525 20.7			
Working pressure	MPa bar	21 210	21 210	21 210			
Maximum flow	l/min gal/min	202 53.4	202 53.4	202 53.4			
Maximum articulation	±°	37		37		37	
Stroke	mm in	452 17.8	480 18.9	455 17.9			

Service

Service accessibility: Large, easy-to-open hood covering the whole engine department, electrically operated. Fluid filters and component breather air filters promote long service intervals. Possibility to monitor, log and analyze data to facilitate troubleshooting.

		L150H		L180H		L220H	
Fuel Tank	l gal	366 88.5	366 88.5	366 88.5			
DEF Tank	l gal	31 8.2	31 8.2	31 8.2			
Engine coolant	l gal	55 12.2	55 12.2	55 12.2			
Hydraulic oil tank	l gal	156 41.2	156 41.2	226 41.2			
Transmission oil	l gal	48 12.7	48 12.7	48 12.7			
Engine oil	l gal	50 13.2	50 13.2	50 13.2			
Axle oil front	l gal	46 11.8	46 11.8	77 20.3			
/rear	l gal	/55 /14.5	/55 /14.5	/71 /18.8			

Specifications.

Tires L150H, L180H: 26.5 R25 L3. Tires L220H: 29.5 R25 L4

	Standard boom			Long boom		
	L150H	L180H	L220H	L150H	L180H	L220H
B	mm ft in 7 070 23' 3"	7 190 23' 7"	7 480 24' 6"	7 570 24' 10"	7 620 25' 0"	7 800 25' 7"
C	mm ft in 3 550 11' 8"	3 550 11' 8"	3 700 12' 2"	3 550 11' 8"	3 550 11' 8"	3 700 12' 2"
D	mm ft in 480 1' 7"	480 1' 7"	530 1' 9"	470 1' 7"	490 1' 7"	530 1' 9"
F	mm ft in 3 580 11' 9"	3 580 11' 9"	3 730 12' 3"	3 570 11' 9"	3 590 11' 9"	3 730 12' 3"
G	mm ft in 2 134 7' 0"	2 134 7' 0"	2 135 7' 0"	2 157 7' 1"	2 133 7' 0"	2 133 7' 0"
J	mm ft in 3 920 12' 10"	4 060 13' 4"	4 230 13' 11"	4 490 14' 9"	4 560 14' 11"	4 600 15' 1"
K	mm ft in 4 340 14' 3"	4 470 14' 8"	4 660 15' 3"	4 900 16' 1"	4 970 16' 4"	5 020 16' 5"
O	° 58	57	56	59	55	56
P _{max}	° 50	49	63	49	49	48
R	° 45	45	43	48	48	44
R ₁ *	° 48	48	47	53	53	49
S	° 66	71	65	61	63	63
T	mm ft in 93 0' 3.7"	131 0' 5.1"	119 0' 4.7"	149 0' 5.9"	207 0' 8.2"	121 0' 4.8"
U	mm ft in 520 1' 9"	570 1' 10"	600 2' 0"	640 2' 1"	660 2' 2"	680 2' 3"
X	mm ft in 2 280 7' 6"	2 280 7' 6"	2 400 7' 10"	2 280 7' 6"	2 280 7' 6"	2 400 7' 10"
Y	mm ft in 2 960 9' 9"	2 960 9' 9"	3 150 10' 4"	2 960 9' 9"	2 960 9' 9"	3 150 10' 4"
Z	mm ft in 3 510 11' 6"	3 810 12' 6"	4 050 13' 3"	3 960 13' 0"	4 180 13' 8"	4 380 14' 5"
a ₂	mm ft in 6 790 22' 3"	6 790 22' 3"	7 100 23' 4"	6 790 22' 3"	6 790 22' 3"	7 100 23' 4"
a ₃	mm ft in 3 820 12' 7"	3 820 12' 7"	3 960 13' 0"	3 820 12' 7"	3 820 12' 7"	3 960 13' 0"
a ₄	±° 37	37	37	37	37	37

* Carry position SAE

Bucket: L150H: 4,0 m³ (5.2 yd³) GP STE P T SEG
 L180H: 4,6 m³ (6.0 yd³) GP STE P T SEG
 L220H: 5,2 m³ (6.8 yd³) GP STE P T SEG

L150H Sales code: WLA80713
 Operating weight (incl. logging cw 1 140 kg (2,513 lb)): 25 660 kg (56,571 lb)
 Operating load: 7 700 kg (16,976 lb)

L180H Sales code: WLA80027
 Operating weight (incl. logging cw 1 140 kg (2,513 lb)): 28 470 kg (62,766 lb)
 Operating load: 8 710 kg (19,202 lb)

L220H Sales code: WLA80852
 Operating weight (incl. logging cw 870 kg (1,918 lb)): 32 810 kg (72,334 lb)
 Operating load: 10 080 kg (22,223 lb)

Tires L150H, L180H: 775/65 R29 L3 | Tires L220H: 875/65 R29 L4

	L150H		L180H		L220H	
	mm	in	mm	in	mm	in
A	m ² yd ² 3,1	3.7	3,5	4.2	4,0	4.8
B	mm in 3 660	144.1	3 870	152.4	3 920	154.3
C	mm in 2 110	83.1	2 150	84.6	2 270	89.4
D	mm in 2 960	116.5	3 150	124.0	3 160	124.4
E	mm in 1 650	65.0	1 720	67.7	1 780	70.1
F	mm in 1 630	64.2	1 700	66.9	1 640	64.6
G	mm in 2 930	115.4	3 040	119.7	3 230	127.2
H	mm in 4 990	196.5	5 170	203.5	5 350	210.6
I	mm in 7 270	286.2	7 610	299.6	7 730	304.3
J	mm in 3 080	121.3	3 370	132.7	3 620	142.5
K	mm in 3 340	131.5	3 710	146.1	3 940	155.1
L	mm in 2 290	90.2	2 410	94.9	2 630	103.5
M	mm in 9 680	381.1	9 980	392.9	10 380	408.7

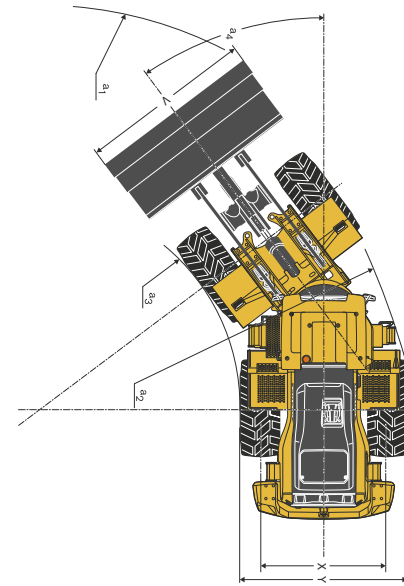



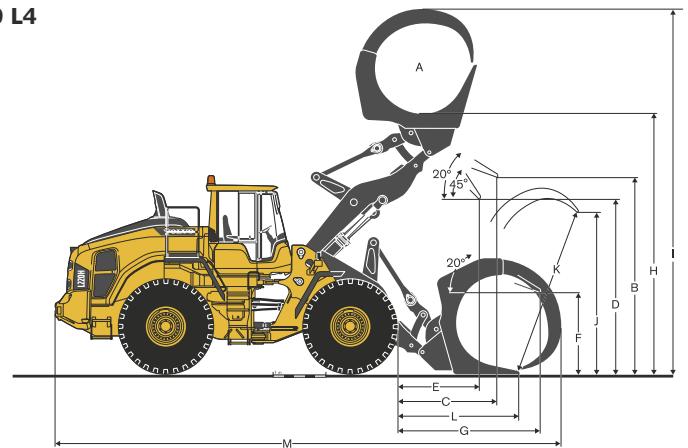
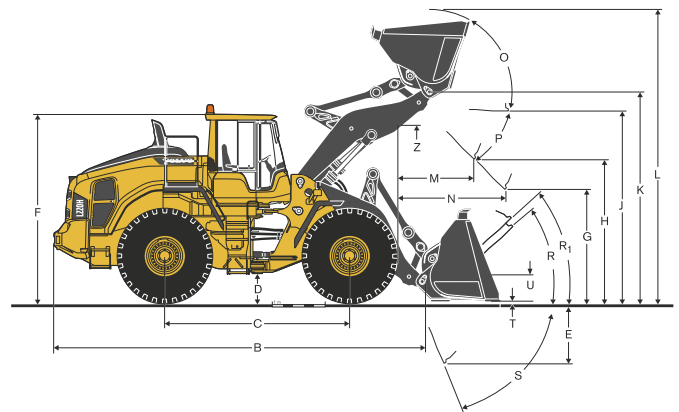







Where applicable, specifications and dimensions are according to ISO 7131, SAE J732, ISO 7546, SAE J742, ISO 14397, SAE J818.



Specifications.

L150H

Tires 26.5 R25 L3	REHANDLING								GENERAL PURPOSE					ROCK***		LIGHT MATERIAL		LONG BOOM*
																		
	4,0 m ³ (5.2 yd ³) STE P BOE	4,4 m ³ (5.8 yd ³) STE P BOE	4,8 m ³ (6.3 yd ³) STE P BOE	5,2 m ³ (6.8 yd ³) STE P BOE	4,0 m ³ (5.2 yd ³) STE P T SEG	4,4 m ³ (5.8 yd ³) STE P T SEG	4,5 m ³ (5.9 yd ³) STE P T SEG	3,5 m ³ (4.6 yd ³) SPN P T SEG	6,8 m ³ (8.9 yd ³) LM P									
Volume, heaped ISO/SAE	m ³ yd ³	4,0 5,2	4,4 5,8	4,8 6,3	5,2 6,8	4,0 5,2	4,4 5,8	4,5 5,9	3,5 4,6	6,8 8,9	-	-	-	-	-	-		
Volume at 110% fill factor	m ³ yd ³	4,4 5,8	4,8 6,3	5,3 6,9	5,7 7,5	4,4 5,8	4,8 6,3	5,0 6,5	3,9 5,0	7,5 9,8	-	-	-	-	-	-		
Static tipping load, straight at 35° turn	kg lb	20 500 45,200	20 230 44,610	19 950 43,990	19 800 43,660	18 100 39,900	17 690 39,010	17 670 38,960	18 730 41,290	16 360 36,080	-2 090	-4,600	-	-	-	-		
at full turn	kg lb	18 320 40,390	18 050 39,810	17 780 39,200	17 630 38,880	16 190 35,700	15 780 34,800	15 760 34,760	16 730 36,890	14 520 32,010	-2 020	-4,450	-	-	-	-		
Breakout force	kN lbf	201,3 45,250	191,7 43,090	183,2 41,190	182,7 41,070	202 45,340	192,0 43,220	184,0 41,460	188,0 42,270	140,0 31,480	9	2,090	-	-	-	-		
A	mm ft in	8 600 28' 2"	8 680 28' 6"	8 750 28' 8"	8 750 28' 9"	8 790 28' 10"	8 860 29' 1"	8 930 29' 3"	8 850 29' 0"	9 230 30' 3"	520	1' 8"	-	-	-	-		
E	mm ft in	1 230 4' 1"	1 300 4' 3"	1 360 4' 6"	1 370 4' 6"	1 400 4' 7"	1 460 4' 9"	1 520 5' 0"	1 450 4' 9"	1 790 5' 10"	-20	-0,8"	-	-	-	-		
H**)	mm ft in	3 020 9' 11"	2 970 9' 9"	2 920 9' 7"	2 920 9' 7"	2 890 9' 6"	2 850 9' 4"	2 800 9' 2"	2 870 9' 5"	2 620 8' 7"	600	1' 11"	-	-	-	-		
L	mm ft in	5 720 18' 9"	5 770 18' 11"	5 880 19' 3"	5 870 19' 3"	5 880 19' 3"	5 990 19' 8"	6 040 19' 10"	5 970 19' 7"	6 140 20' 2"	570	1' 10"	-	-	-	-		
M**)	mm ft in	1 220 4' 0"	1 270 4' 2"	1 320 4' 4"	1 320 4' 4"	1 360 4' 5"	1 410 4' 7"	1 450 4' 9"	1 420 4' 8"	1 700 5' 7"	-50	-2"	-	-	-	-		
N**)	mm ft in	1 800 5' 11"	1 830 6' 0"	1 860 6' 1"	1 860 6' 1"	1 880 6' 2"	1 910 6' 3"	1 930 6' 4"	1 930 6' 4"	1 960 6' 5"	410	1' 4"	-	-	-	-		
V	mm in	3 200 125"	3 200 125"	3 200 125"	3 400 133"	3 230 127"	3 200 125"	3 000 118"	3 230 127"	3 200 125"	0	-	-	-	-	-		
a ₁ clearance circle	mm ft in	14 640 48' 0"	14 670 48' 2"	14 700 48' 3"	14 890 48' 10"	14 750 48' 5"	14 760 48' 5"	14 600 47' 11"	14 800 48' 7"	14 940 49' 0"	0	-	-	-	-	-		
Operating weight	kg lb	25 090 55,320	25 300 55,780	25 500 56,220	25 620 56,490	24 090 53,130	24 450 53,920	24 420 53,840	25 320 55,820	24 920 54,950	1 940	1,940	-	-	-	-		

*) Measured with 4,0 m³ (5.2 yd³) GP bucket

Note: This only applies to genuine Volvo attachments.

**) Measured to the tip of the bucket teeth or bolt-on edge. Dump height to bucket edge measured at 45° dump angle. (Spade nose buckets at 42°.)

**) Measured with L5 tires

Bucket Selection Chart

The chosen bucket is determined by the density of the material and the expected bucket fill factor. The actual bucket volume is often larger than the rated capacity, due to the features of the TP linkage, including an open bucket design, good rollback angles in all positions and good bucket filling performance. The example represents a standard boom configuration.

Example: Sand and gravel. Fill factor ~ 105%. Density 1,6 t/m³.
Result: The 4,0 m³ bucket carries 4,2 m³. For optimum stability always consult the bucket selection chart.

Material	Bucket fill, %	Material density		ISO/SAE bucket volume		Actual volume	
		t/m ³	lb/yd ³	m ³	yd ³	m ³	yd ³
Earth/Clay	~ 110	~ 1,6	~ 2,698	4,0	5,2	~ 4,4	~ 5,8
		~ 1,5	~ 2,530	4,4	5,8	~ 4,8	~ 6,3
Sand/Gravel	~ 105	~ 1,6	~ 2,698	4,0	5,2	~ 4,2	~ 5,5
		~ 1,5	~ 2,530	4,4	5,8	~ 4,6	~ 6,0
Aggregate	~ 100	~ 1,8	~ 3,035	4,4	5,8	~ 4,4	~ 5,8
		~ 1,7	~ 2,867	4,8	6,3	~ 4,8	~ 6,3
		~ 1,5	~ 2,530	5,2	6,8	~ 5,2	~ 6,8
Rock	≤ 100	~ 1,7	~ 2,867	3,5	4,6	~ 3,5	~ 4,6

The size of rock buckets is optimized for optimal penetration and filling capability rather than the density of the material.

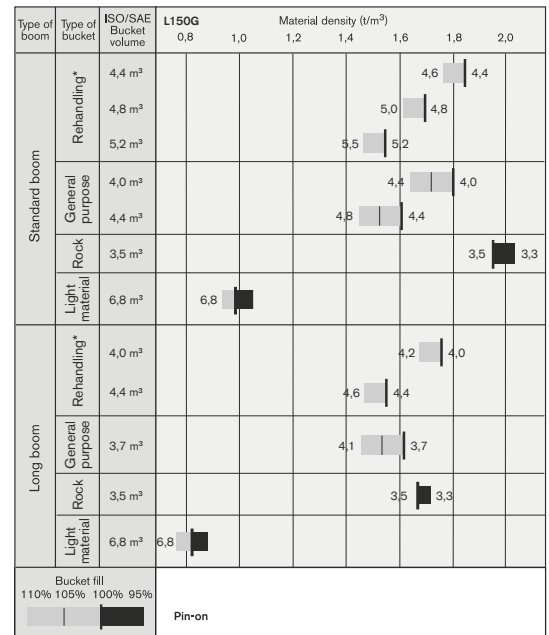











How to read bucket fill factor

* Including counterweight

Supplemental Operating Data

Tires 26.5 R25 L3	Standard boom								Long boom					
	26.5 R25 L4		26.5 R25 L5		775/65 R29 L3		26.5 R25 L4		26.5 R25 L5		775/65 R29 L3			
Width over tires	mm in	+5 +0,2	+30 +1,2	+180 +7,1	+5 +0,2	+30 +1,2	+180 +7,1	+5 +0,2	+30 +1,2	+180 +7,1	+5 +0,2	+30 +1,2		
Ground clearance	mm in	+18 +0,7	+30 +1,2	+10 +0,4	+18 +0,7	+30 +1,2	+10 +0,4	+18 +0,7	+30 +1,2	+10 +0,4	+18 +0,7	+30 +1,2		
Tipping load, full turn	kg lb	+250 +551	+760 +1676	+590 +1,300	+220 +485	+640 +1,411	+500 +1,102	+220 +485	+640 +1,411	+500 +1,102	+220 +485	+640 +1,411		
Operating weight	kg lb	+400 +882	+1 060 +2,337	+760 +1,676	+400 +882	+1 050 +2,315	+750 +1,653	+400 +882	+1 050 +2,315	+750 +1,653	+400 +882	+1 050 +2,315		

L180H

Tires 26.5 R25 L3	REHANDLING								GENERAL PURPOSE				ROCK***		LIGHT MATERIAL		LONG BOOM*
																	
	4,8 m ³ (6.3 yd ³) STE P BOE	5,2 m ³ (6.8 yd ³) STE P BOE	5,5 m ³ (7.2 yd ³) STE P BOE	5,8 m ³ (7.6 yd ³) STE P BOE	4,4 m ³ (5.8 yd ³) STE P T SEG	4,6 m ³ (6.0 yd ³) STE P T SEG	4,8 m ³ (6.3 yd ³) STE P T SEG	4,2 m ³ (5.5 yd ³) SPN P T SEG	7,8 m ³ (10.2 yd ³) LM P								
Volume, heaped ISO/SAE	m ³ yd ³	4,8 6,3	5,2 6,8	5,5 7,2	5,8 7,6	4,4 5,8	4,6 6,0	4,8 6,3	4,2 5,5	7,8 10,2	-	-					
Volume at 110% fill factor	m ³ yd ³	5,3 6,9	5,7 7,5	6,1 7,9	6,4 8,3	4,8 6,3	5,1 6,6	5,3 6,9	4,6 6,0	8,6 11,2	-	-					
Static tipping load, straight at 35° turn	kg lb	23 670 52,190	23 520 51,860	23 350 51,480	23 210 51,180	21 540 47,500	21 560 47,540	21 360 47,090	22 250 49,060	20 430 45,040	-3 820	-8,420					
at full turn	kg lb	20 710 45,660	20 560 45,330	20 390 44,970	20 260 44,680	18 860 41,600	18 880 41,620	18 690 41,200	19 470 42,930	17 800 39,260	-3 450	-7,590					
Breakout force	kN lbf	224,9 50,570	224,2 50,420	216,2 48,600	210,0 47,230	235,9 53,050	236,0 53,060	226,4 50,910	212,6 47,790	173,5 39,000	3,9	870					
A	mm ft in	8 890 29' 2"	8 890 29' 2"	8 960 29' 5"	9 010 29' 7"	9 000 29' 6"	9 000 29' 6"	9 070 29' 9"	9 140 30' 0"	9 360 30' 8"	470	1' 6"					
E	mm ft in	1 430 4' 8"	1 430 4' 8"	1 490 4' 11"	1 540 5' 1"	1 530 5' 0"	1 530 5' 0"	1 590 5' 3"	1 650 5' 5"	1 860 6' 1"	20	0,6"					
H**)	mm ft in	3 060 10' 0"	3 050 10' 0"	3 010 9' 11"	2 970 9' 9"	2 990 9' 10"	2 990 9' 10"	2 940 9' 8"	2 910 9' 7"	2 690 8' 10"	500	1' 7"					
L	mm ft in	6 010 19' 9"	6 010 19' 9"	6 040 19' 10"	6 110 20' 0"	6 130 20' 1"	6 170 20' 3"	6 180 20' 3"	6 320 20' 9"	6 300 20' 8"	500	1' 7"					
M**)	mm ft in	1 330 4' 4"	1 330 4' 4"	1 370 4' 6"	1 410 4' 8"	1 420 4' 8"	1 420 4' 8"	1 460 4' 10"	1 520 5' 0"	1 610 5' 3"	20	0,6"					
N**)	mm ft in	1 960 6' 5"	1 960 6' 5"	1 990 6' 6"	2 000 6' 7"	2 020 6' 7"	2 020 6' 7"	2 040 6' 8"	2 080 6' 10"	2 050 6' 9"	410	1' 4"					
V	mm in	3 200 125"	3 400 133"	3 400 133"	3 400 133"	3 200 125"	3 200 125"	3 200 125"	3 230 127"	3 400 133"	-	-					
a ₁ clearance circle	mm ft in	14 800 48' 7"	14 990 49' 2"	15 010 49' 3"	15 040 49' 4"	14 850 48' 9"	14 850 48' 9"	14 880 48' 10"	14 960 49' 1"	15 220 49' 11"	-	11'					
Operating weight	kg lb	28 070 61,890	28 190 62,160	28 290 62,380	28 360 62,540	27 020 59,590	27 060 59,670	27 120 59,800	28 440 62,700	27 470 60,570	270	590					

*) Measured with 4,6 m³ (6.0 yd³) GP bucket Note: This only applies to genuine Volvo attachments.
 **) Measured to the tip of the bucket teeth or bolt-on edge. Dump height to bucket edge measured at 45° dump angle. (Spade nose buckets at 42°.)
 ***) Measured with L5 tires

Bucket Selection Chart

The chosen bucket is determined by the density of the material and the expected bucket fill factor. The actual bucket volume is often larger than the rated capacity, due to the features of the TP linkage, including an open bucket design, good rollback angles in all positions and good bucket filling performance. The example represents a standard boom configuration.
 Example: Sand and gravel. Fill factor ~ 105%. Density 1,6 t/m³.
 Result: The 4,6 m³ bucket carries 4,8 m³. For optimum stability always consult the bucket selection chart

Material	Bucket fill, %	Material density		ISO/SAE bucket volume		Actual volume	
		t/m ³	lb/yd ³	m ³	yd ³	m ³	yd ³
Earth/Clay	~ 110	~ 1,7	~ 2,867	4,9	6,4	~ 4,8	~ 6,3
		~ 1,6	~ 2,698	5,2	6,8	~ 5,1	~ 6,7
		~ 1,5	~ 2,530	5,4	7,1	~ 5,3	~ 6,9
Sand/Gravel	~ 105	~ 1,7	~ 2,867	4,4	5,8	~ 4,6	~ 6,0
		~ 1,6	~ 2,698	4,6	6,0	~ 4,8	~ 6,3
		~ 1,5	~ 2,530	4,8	6,3	~ 5,1	~ 6,7
Aggregate	~ 100	~ 1,8	~ 3,035	5,2	6,8	~ 5,2	~ 6,8
		~ 1,7	~ 2,867	5,5	7,2	~ 5,5	~ 7,2
		~ 1,6	~ 2,698	5,8	7,6	~ 5,8	~ 7,6
Rock	≤100	~ 1,7	~ 2,867	4,3	5,6	~ 4,3	~ 5,6

The size of rock buckets is optimized for optimal penetration and filling capability rather than the density of the material.

Type of boom	Type of bucket	ISO/SAE Bucket volume	Material density (t/m ³)								
			0,8	1,0	1,2	1,4	1,6	1,8	2,0		
Standard boom	Rehandling*	5,2 m ³							5,5	5,2	
		5,5 m ³						5,8	5,5		
		5,8 m ³					6,1	5,8			
	General purpose	4,4 m ³							4,8	4,4	
		4,6 m ³						5,1	4,6		
		4,8 m ³						5,3	4,8		
Rock	4,2 m ³								4,2	4,0	
	Light material	7,8 m ³	7,8								
Long boom	Rehandling*	4,8 m ³							5,0	4,8	
		5,2 m ³						5,5	5,2		
	General purpose	4,4 m ³							4,8	4,4	
		4,2 m ³								4,2	4,0
	Light material	7,8 m ³	7,8								











How to read bucket fill factor Pin-on * Including counterweight

Supplemental Operating Data

Tires 26.5 R25 L3	Standard boom								Long boom					
	26.5 R25 L4		26.5 R25 L5		775/65 R29 L3		26.5 R25 L4		26.5 R25 L5		775/65 R29 L3			
Width over tires	mm in	+5 +0,2	+30 +1,2	+130 +5,1	+5 +0,2	+30 +1,2	+130 +5,1							
Ground clearance	mm in	+18 +0,7	+40 +1,6	+10 +0,4	+18 +0,7	+40 +1,6	+10 +0,4							
Tipping load, full turn	kg lb	+280 +617	+770 +1,698	+600 +1,323	+250 +551	+760 +1,676	+530 +1,168							
Operating weight	kg lb	+400 +882	+1 050 +2,315	+920 +2,028	+400 +882	+1 050 +2,315	+1 120 +2,469							

Specifications.

L220H

Tires 29.5 R25 L3	REHANDLING								GENERAL PURPOSE				ROCK***	LIGHT MATERIAL	LONG BOOM*
															
	5,6 m ³ (7.3 yd ³) STE P BOE	5,9 m ³ (7.7 yd ³) STE P BOE	6,3 m ³ (8.2 yd ³) STE P BOE	4,9 m ³ (6.4 yd ³) STE P T SEG	5,2 m ³ (6.8 yd ³) STE P T SEG	5,6 m ³ (7.3 yd ³) STE P T SEG	4,5 m ³ (5.9 yd ³) SPN P T SEG	5,0 m ³ (6.5 yd ³) SPN P T SEG	8,2 m ³ (10.7 yd ³) LM P						
Volume, heaped ISO/SAE	m ³ yd ³	5,6 7,3	5,9 7,7	6,3 8,2	4,9 6,4	5,2 6,8	5,6 7,3	4,5 5,9	5,0 6,5	8,2 10,7	0 -				
Volume at 110% fill factor	m ³ yd ³	6,2 8,1	6,5 8,5	6,9 9,1	5,4 7	5,7 7,5	6,2 8,1	5,0 6,5	5,5 7,2	9,0 11,8	0 -				
Static tipping load, straight at 35° turn	kg lb	25 270 55,710	25 140 55,430	24 960 55,030	23 960 52,840	23 900 52,700	23 600 52,030	24 900 54,900	23 770 52,410	22 820 50,310	-2 890 -6,370				
at full turn	kg lb	22 420 49,430	22 290 49,160	22 120 48,770	21 280 46,930	21 220 46,790	20 940 46,160	22 150 48,840	21 090 46,500	20 190 44,510	-2 650 -5,840				
Breakout force	kN lbf	228,9 51,460	223,1 50,150	215,0 48,330	255,9 57,530	244,5 54,990	229,0 51,490	211,5 47,560	196,5 44,190	190,8 42,900	3,4 670				
A	mm ft in	9 270 30' 5"	9 310 30' 7"	9 380 30' 9"	9 310 30' 7"	9 350 30' 8"	9 460 31' 0"	9 580 31' 5"	9 730 31' 11"	9 580 31' 5"	310 1'				
E	mm ft in	1 470 4' 10"	1 510 4' 11"	1 570 5' 2"	1 510 4' 11"	1 540 5' 1"	1 640 5' 5"	1 730 5' 8"	1 860 6' 1"	1 750 5' 9"	-30 -0,6"				
H**)	mm ft in	3 160 10' 4"	3 130 10' 3"	3 080 10' 1"	3 130 10' 3"	3 110 10' 3"	3 040 9' 11"	3 030 9' 11"	2 930 9' 7"	2 910 9' 7"	370 1' 2"				
L	mm ft in	6 260 20' 6"	6 290 20' 7"	6 370 20' 11"	6 370 20' 11"	6 440 21' 2"	6 440 21' 2"	6 450 21' 2"	6 510 21' 4"	6 450 21' 2"	360 1' 2"				
M**)	mm ft in	1 400 4' 7"	1 440 4' 9"	1 480 4' 10"	1 430 4' 8"	1 470 4' 10"	1 560 5' 1"	1 700 5' 7"	1 800 5' 11"	1 610 5' 3"	-30 -0,6"				
N**)	mm ft in	2 100 6' 11"	2 120 7' 0"	2 150 7' 1"	2 120 6' 11"	2 160 7' 1"	2 200 7' 3"	2 250 7' 5"	2 300 7' 6"	2 180 7' 2"	270 10'				
V	mm in	3 400 133"	3 400 133"	3 400 133"	3 430 135"	3 400 133"	3 400 133"	3 430 135"	3 430 135"	3 700 145"	- -				
a ₁ clearance circle	mm ft in	15 570 51' 1"	15 590 51' 2"	15 620 51' 3"	15 610 51' 3"	15 610 51' 3"	15 670 51' 5"	15 770 51' 9"	15 850 52' 0"	16 020 52' 7"	- -				
Operating weight	kg lb	31 950 70,440	32 020 70,610	32 130 70,850	31 160 68,710	31 190 68,770	31 260 68,920	32 710 72,130	33 130 73,050	31 660 69,800	380 860				

*) Measured with 5,2 m³ (6.8 yd³) bucket. Note: This only applies to genuine Volvo attachments.
 **) Measured to the tip of the bucket teeth or bolt-on edge. Dump height to bucket edge measured at 45° dump angle. (Spade nose buckets at 42°.)
 ***) Measured with L5 tires

Bucket Selection Chart

The chosen bucket is determined by the density of the material and the expected bucket fill factor. The actual bucket volume is often larger than the rated capacity, due to the features of the TP linkage, including an open bucket design, good rollback angles in all positions and good bucket filling performance. The example represents a standard boom configuration.
 Example: Sand and gravel. Fill factor ~ 105%. Density 1,6 t/m³.
 Result: The 5,2 m³ bucket carries 5,5 m³. For optimum stability always consult the bucket selection chart.

Material	Bucket fill, %	Material density		ISO/SAE bucket volume		Actual volume	
		t/m ³	lb/yd ³	m ³	yd ³	m ³	yd ³
Earth/Clay	~ 110	~ 1,6	~ 2,698	4,9	6,4	~ 5,4	~ 7,1
		~ 1,5	~ 2,530	5,2	6,8	~ 5,7	~ 7,5
		~ 1,4	~ 2,361	5,4	7,1	~ 5,9	~ 7,7
Sand/Gravel	~ 105	~ 1,7	~ 2,867	4,9	6,4	~ 5,1	~ 6,7
		~ 1,6	~ 2,698	5,2	6,8	~ 5,5	~ 7,2
		~ 1,5	~ 2,530	5,4	7,1	~ 5,7	~ 7,5
Aggregate	~ 100	~ 1,8	~ 3,035	5,6	7,3	~ 5,6	~ 7,3
		~ 1,7	~ 2,867	5,9	7,7	~ 5,9	~ 7,7
		~ 1,6	~ 2,698	6,3	8,2	~ 6,3	~ 8,2
Rock	≤100	~ 1,7	~ 2,867	4,5	5,9	~ 4,5	~ 5,9

The size of rock buckets is optimized for optimal penetration and filling capability rather than the density of the material.

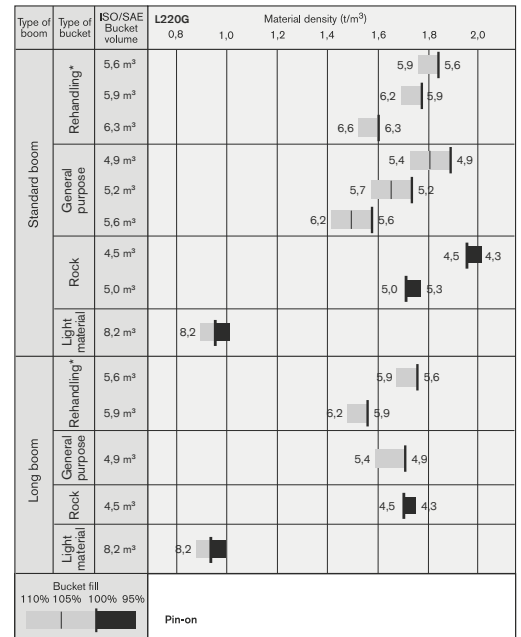

How to read bucket fill factor * Including counterweight

Supplemental Operating Data

Tires 29.5 R25 L4	Standard boom								Long boom					
	29.5 R25 L3		29.5 R25 L5		875/65 R29 L4		29.5 R25 L3		29.5 R25 L5		875/65 R29 L4			
Width over tires	mm in	-20 -0,8	+35 +1,4	+95 +3,7	-20 -0,8	+35 +1,4	+95 +3,7	-20 -0,8	+35 +1,4	+95 +3,7	-20 -0,8	+35 +1,4		
Ground clearance	mm in	±0 ±0	+40 +1,6	-10 -0,4	±0 ±0	+40 +1,6	-20 -0,8	±0 ±0	+40 +1,6	-20 -0,8	±0 ±0	+40 +1,6		
Tipping load, full turn	kg lb	-100 -220	+1 010 +2,226	+180 +396	-90 -198,4	+930 +2,050	+180 +396	-90 -198,4	+930 +2,050	+180 +396	-90 -198,4	+930 +2,050		
Operating weight	kg lb	-80 -176	+1 490 +3,284	+650 +1,433	-80 -176,4	+1 500 +3,306	+650 +1,433	-80 -176,4	+1 500 +3,306	+650 +1,433	-80 -176,4	+1 500 +3,306		

Equipment.

STANDARD EQUIPMENT

	L150H	L180H	L220H
Service and maintenance			
Engine oil remote drain and fill	•	•	•
Lubrication manifolds, ground accessible	•	•	•
Pressure check connections: transmission and hydraulic, quick-connects	•	•	•
Tool box, lockable	•	•	•
CareTrack	•	•	•
Telematics, 3-Year Subscription	•	•	•
Engine			
Exhaust after-treatment system	•	•	•
Three stage air cleaner, primary and secondary filter	•	•	•
Preheating of induction air	•	•	•
Fuel pre-filter with water trap	•	•	•
Fuel filter	•	•	•
Crankcase breather oil trap	•	•	•
Exterior radiator air intake protection	•	•	•
Electrical system			
24 V, pre-wired for optional accessories	•	•	•
Alternator 24 V/ 80 A	•	•	•
Battery disconnect switch with removable key	•	•	•
Fuel gauge	•	•	•
Hour meter	•	•	•
Electric horn	•	•	•
Instrument cluster:	•	•	•
Fuel level	•	•	•
Transmission temperature	•	•	•
Coolant temperature	•	•	•
Instrument lighting	•	•	•
Lighting:	•	•	•
Twin halogen front headlights with high and low beams	•	•	•
Parking lights	•	•	•
Double brake and tail lights	•	•	•
Turn signals with flashing hazard light function	•	•	•
Halogen work lights (2 front and 2 rear)	•	•	•
Contronic monitoring system			
Monitoring and logging of machine data	•	•	•
Contronic display	•	•	•
Fuel consumption	•	•	•
Ambient temperature	•	•	•
Clock	•	•	•
Test function for warning and indicator lights	•	•	•
Brake test	•	•	•
Test function, sound level at max fan speed	•	•	•
Warning and indicator lights:	•	•	•
Battery charging	•	•	•
Parking brake	•	•	•
Warning and display message:	•	•	•
Regeneration	•	•	•
Engine coolant temperature	•	•	•
Charge-air temperature	•	•	•
Engine oil temperature	•	•	•
Engine oil pressure	•	•	•
Transmission oil temperature	•	•	•
Transmission oil pressure	•	•	•
Hydraulic oil temperature	•	•	•
Brake pressure	•	•	•
Parking brake applied	•	•	•
Brake charging	•	•	•
Overspeed at direction change	•	•	•
Axle oil temperature	•	•	•
Steering pressure	•	•	•
Crankcase pressure	•	•	•
Attachment lock open	•	•	•
Level warnings:	•	•	•
Fuel level	•	•	•
Engine oil level	•	•	•
Engine coolant level	•	•	•
Transmission oil level	•	•	•
Hydraulic oil level	•	•	•
Washer fluid level	•	•	•
Engine torque reduction in case of malfunction indication:	•	•	•
High engine coolant temperature	•	•	•
High engine oil temperature	•	•	•
Low engine oil pressure	•	•	•
High crankcase pressure	•	•	•

	L150H	L180H	L220H
Contronic monitoring system			
High charge-air temperature	•	•	•
Engine shutdown to idle in case of malfunction indication:	•	•	•
High transmission oil temperature	•	•	•
Slip in transmission clutches	•	•	•
Keypad, background lit	•	•	•
Start interlock when gear is engaged	•	•	•
Drivetrain			
Automatic Power Shift	•	•	•
Fully automatic gearshifting, 1-4	•	•	•
PWM-controlled gearshifting	•	•	•
Forward and reverse switch by hydraulic lever console	•	•	•
Indicator glass for transmission oil level	•	•	•
Differentials: Front, 100% hydraulic diff lock. Rear, conventional.	•	•	•
OptiShift	•	•	•
Brake system			
Dual brake circuits	•	•	•
Dual brake pedals	•	•	•
Secondary brake system	•	•	•
Parking brake, electrical-hydraulic	•	•	•
Brake wear indicators	•	•	•
Cab			
Tiltable Cab	•	•	•
ROPS (ISO 3471), FOPS (ISO 3449)	•	•	•
Single key kit door/start	•	•	•
Acoustic inner lining	•	•	•
Ashtray	•	•	•
Cigarette lighter, 24 V power outlet	•	•	•
Lockable door	•	•	•
Cab heating with fresh air inlet and defroster	•	•	•
Fresh air inlet with two filters	•	•	•
Automatic heat control	•	•	•
Floor mat	•	•	•
Dual interior lights	•	•	•
Interior mirror on the left and reverse camera monitor on the right	•	•	•
Dual exterior rear-view mirrors	•	•	•
Sliding window, right side	•	•	•
Tinted safety glass	•	•	•
Retractable seat belt (SAE J386)	•	•	•
Adjustable steering wheel	•	•	•
Storage compartment	•	•	•
Document pocket	•	•	•
Sun visor	•	•	•
Beverage holder	•	•	•
Windshield washer front and rear	•	•	•
Windshield wipers front and rear	•	•	•
Interval function for front and rear wipers	•	•	•
Hydraulic system			
Main valve, double acting 2-spool with hydraulic pilots	•	•	•
Variable displacement axial piston pumps (3) for:			
1 Working hydraulic system			
2 Working hydraulic system, Steering- and Brake system	•	•	•
3 Cooling fan and Brake system			
Electro-hydraulic servo controls	•	•	•
Electric level lock	•	•	•
Boom kick-out, automatic	•	•	•
Bucket positioner, automatic	•	•	•
Double-acting hydraulic cylinders	•	•	•
Indicator glass for hydraulic oil level	•	•	•
Hydraulic oil cooler	•	•	•
External equipment			
Fenders, front and rear	•	•	•
Viscous cab mounts	•	•	•
Rubber engine and transmission mounts	•	•	•
Easy-to-open engine hood	•	•	•
Frame, joint lock	•	•	•
Vandalism lock prepared for	•	•	•
Batteries	•	•	•
Engine compartment	•	•	•
Radiator grille	•	•	•
Lifting eyes	•	•	•
Tie-down eyes	•	•	•
Tow hitch	•	•	•
Counterweight, pre-drilled for optional guards	•	•	•

Equipment.

OPTIONAL EQUIPMENT

	L150H	L180H	L220H
Service and maintenance			
Automatic lubrication system	•	•	•
Automatic lubrication system for long boom	•	•	•
Grease nipple guards	•	•	•
Oil sampling valve	•	•	•
Refill pump for grease to lube system	•	•	•
Tool kit	•	•	•
Cleaner kit, with air blow gun	•	•	•
Wheel nut wrench kit	•	•	•
Engine			
Air pre-cleaner, cyclone type	•	•	•
Air pre-cleaner, oil-bath type	•	•	•
Air pre-cleaner, turbo type	•	•	•
Radiator corrosion protection	•	•	•
Radiator and hydraulic oil cooler, corr. prot.	•	•	•
Engine block heater 230 V/110 V	•	•	•
ESW, Disabled engine protection	•	•	•
Air intake protection (for grill in waste)	•	•	•
Fuel fill strainer	•	•	•
Hand throttle control	•	•	•
Max. fan speed, hot climate	•	•	•
Reversible cooling fan	•	•	•
Reversible cooling fan and axle oil cooler	•	•	•
Fuel filter, extra	•	•	•
Fuel heater	•	•	•
Electrical system			
Alternator 120 amp, heavy-duty	•	•	•
Anti-theft device	•	•	•
Headlights, assym. left	•	•	•
License plate holder, lighting	•	•	•
Rear view camera incl. monitor, color	•	•	•
Rear-view mirrors, adjustable, el. heated	•	•	•
Rear view mirrors, Long arm	•	•	•
Rear view mirrors, adjustable, el. heated, Long arm	•	•	•
Reduced function working lights, reverse gear activated	•	•	•
Reverse alarm	•	•	•
Reverse warning light, strobe lighting	•	•	•
Shortened headlight support brackets	•	•	•
Side marker lamps	•	•	•
Rotating beacon	•	•	•
Tail light LED	•	•	•
Working lights, attachments	•	•	•
Working lights front, high intensity discharge (HID)	•	•	•
Working lights front, on cab, dual	•	•	•
Working lights front, extra	•	•	•
Working lights front, extra, 2 LED lamps	•	•	•
Work lamp, front on cab, 2 LED lamps	•	•	•
Work lamp, front on cab, 4 LED lamps	•	•	•
Work lamp, rear on cab, 2 LED lamps	•	•	•
Work lamp, rear on cab, 4 LED lamps	•	•	•
Without work lamp side on cab, std	•	•	•
Work lamp, side on cab, 1 LED lamp	•	•	•
Work lamp, side on cab, 4 LED lamps	•	•	•
Work lamp, rear in grille, 2 LED lamps	•	•	•
Work lamp, rear in grille, 4 LED lamps	•	•	•
Work lamp, front above head lamps, 2 LED lamps	•	•	•
Cab			
Anchorage for Operator's manual	•	•	•
Automatic Climate Control, ACC	•	•	•
ACC control panel, with Fahrenheit scale	•	•	•
Asbestos dust protection filter	•	•	•
Cab air pre-cleaner, cyclone type	•	•	•

	L150H	L180H	L220H
Cab			
Carbon filter	•	•	•
Cab roof, heavy-duty	•	•	•
Cover plate, under cab			
Lunch box holder	•	•	•
Armrest, operator's seat, ISRI, left only	•	•	•
Armrest, operators seat, Volvo, left only	•	•	•
Operator's seat, Volvo, air susp, heavy-duty, for CDC and/or elservo	•	•	•
Operator's seat, ISRI, air susp, heat, high back	•	•	•
Operators seat, Volvo air susp, heavy duty, high back, heat, not for CDC	•	•	•
Radio installation kit incl. 11 amp 12 volt outlet, left side	•	•	•
Radio installation kit incl. 11 amp 12 volt outlet, right side	•	•	•
Radio installation kit incl. 20 amp 12 volt outlet	•	•	•
Radio with CD-player	•	•	•
Seat belt, 3", (width 75 mm)	•	•	•
Steering wheel knob	•	•	•
Sun blinds, rear windows	•	•	•
Sun blinds, side windows	•	•	•
Timer cab heating	•	•	•
Window, sliding, door	•	•	•
Universal door/ignition key	•	•	•
Front view mirror	•	•	•
Drivetrain			
Diff lock front 100%, Limited Slip rear	•	•	•
Speed limiter, 20 km/h	•	•	•
Speed limiter, 30 km/h	•	•	•
Speed limiter, 40 km/h	•	•	•
Wheel/axle seal guards	•	•	•
Brake system			
Oil cooler and filter front & rear axle	•	•	•
Stainless steel, brake lines	•	•	•
Hydraulic system			
Attachment bracket, welded	•	•	•
Boom suspension system	•	•	•
Separate attachment locking, standard boom	•	•	•
Separate attachment locking, long boom	•	•	•
Arctic kit, attachment locking hoses and 3rd hydr. function	•	•	•
Arctic kit, pilot hoses and brake accum. incl. hydr. oil	•	•	•
Boom cylinder hose and tube guards	•	•	•
Boom cylinder hose and tube guards for long boom	•	•	•
Hydraulic fluid, biodegradable, Volvo	•	•	•
Hydraulic fluid, fire-resistant	•	•	•
Hydraulic fluid, for hot climate	•	•	•
Hydraulic fluid, Mineral for cold climate	•	•	•
Electro-hydraulic function, 3rd	•	•	•
Electro-hydraulic function, 3rd for long boom	•	•	•
Electro-hydraulic function, 3rd-4th	•	•	•
Electro-hydraulic function, 3rd-4th for long boom	•	•	•
Electro-hydraulic servo controls for long boom	•	•	•
External equipment			
Cab ladder, rubber-suspended	•	•	•
Deleted front mudguards	•	•	•
Mudguard widener, front/rear for 80-series tires	•	•	•
Mudguard widener, front/rear for 65-series tires	•	•	•
Fire suppression system	•	•	•
Mudguards, full cover, rear for 80-series tires	•	•	•
Mudguards, full cover, rear for 65-series tires	•	•	•
Long boom	•	•	•

	L150H	L180H	L220H
Protective equipment			
Belly guard front	•	•	•
Belly guard rear	•	•	•
Belly guard rear, oil pan	•	•	•
Cover plate, heavy-duty, front frame	•	•	•
Cab roof heavy duty	•	•	•
Guards for front headlights	•	•	•
Guards for radiator grill	•	•	•
Guards for tail lights	•	•	•
Windows, side and rear guards	•	•	•
Windshield guard	•	•	•
Corrosion protection, painting of machine	•	•	•
Corrosion protection, painting of attachment bracket	•	•	•
Bucket Teeth protection	•	•	•
Other equipment			
CE-marking	•	•	•
Comfort Drive Control (CDC)	•	•	•
Reflecting stickers(decals), machine contour	•	•	•
Reflecting sticker(stripes), machine contour Cab	•	•	•
Counterweight, logging	•	•	•
Counter weight, block handling			•
Counterweight, re-handling	•	•	•
Counterweight, signal painted, chevrons	•	•	•
Log pusher	•	•	•
Secondary steering with automatic test function	•	•	•
Sound decal, EU	•	•	•
Noise reduction kit, exterior	•	•	•
Sign, slow moving vehicle	•	•	•
CareTrack, GSM	•	•	•
CareTrack, GSM/Satellite	•	•	•
Tires			
26.5 R25	•	•	•
29.5 R25			•
775/65 R29	•	•	•
875/65 R29			•
Attachments			
Buckets:			
Rock straight or spade nose	•	•	•
General purpose	•	•	•
Re-handling	•	•	•
Side-dump			•
Light material	•	•	•
Wear parts:			
Bolt-on and weld-on bucket teeth	•	•	•
Segments	•	•	•
Cutting edge in three sections, bolt-on	•	•	•
Fork equipment	•	•	•
Material handling arm	•	•	•
Log grapples	•	•	•

SELECTION OF VOLVO OPTIONAL EQUIPMENT

Attachment bracket with hydraulic attachment lock



Comfort Drive Control (CDC) /Joy stick Steering



Electro hydraulic 3rd/4th function



LED Lights



Boom Suspension System (BSS) /Ride Control



Reflectors



Not all products are available in all markets. Under our policy of continuous improvement, we reserve the right to change specifications and design without prior notice. The illustrations do not necessarily show the standard version of the machine.

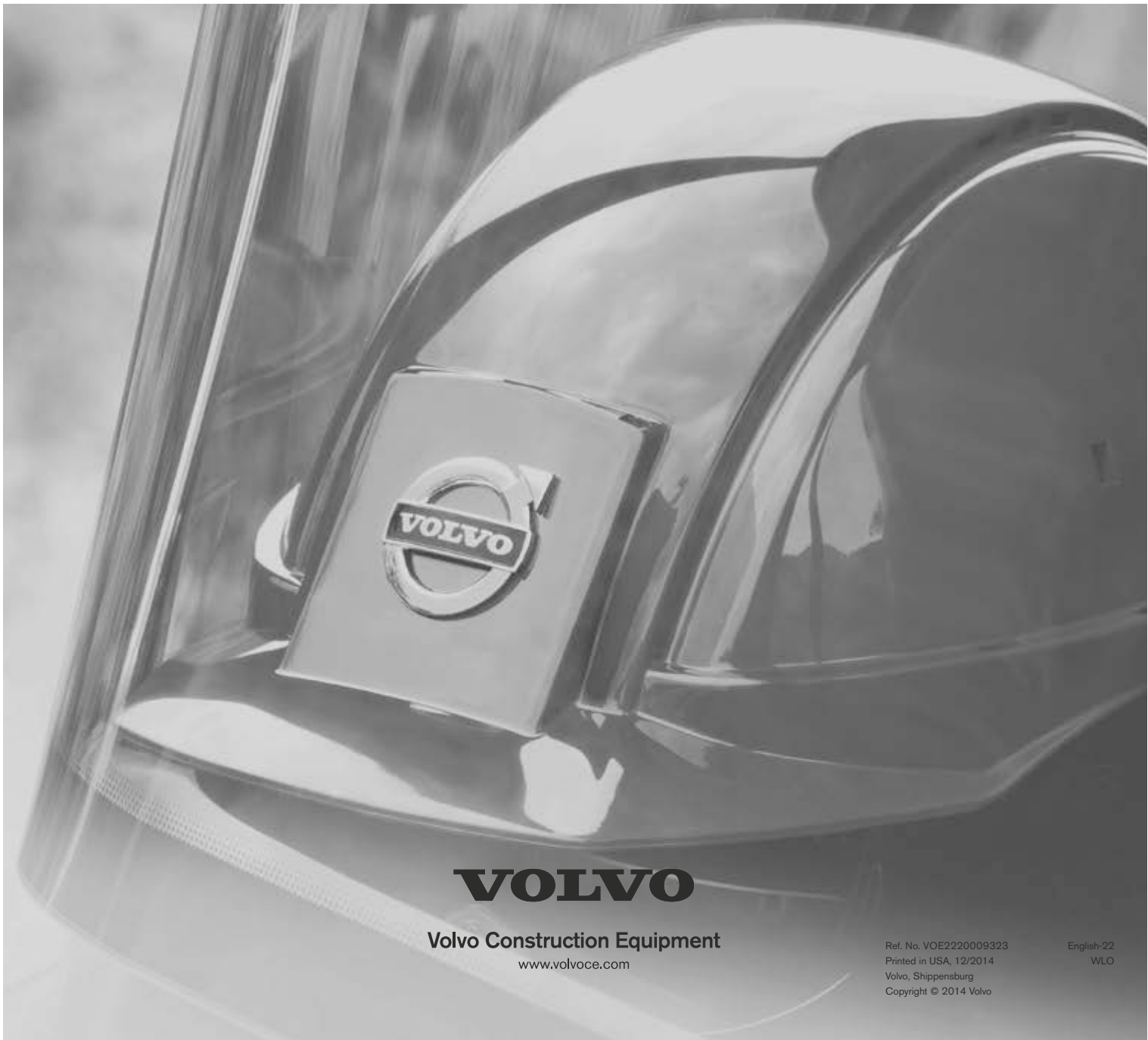

VOLVO

Volvo Construction Equipment

www.volvoce.com

Ref. No. VOE2220009323
Printed in USA, 12/2014
Volvo, Shippensburg
Copyright © 2014 Volvo

English-22
WLO