



Volvo Construction Equipment

ECR58D

Volvo Compact Excavators 5.5-6.8 t (12,125-14,990 lb) 49 hp



Powered to perform

Introducing the Volvo ECR58D, a compact short swing radius excavator that delivers a powerful, efficient performance. Whether you're working in the road construction, utilities, landscaping or any other application, the ECR58D gives you precise control and smooth operation.

Volvo engine

Volvo's premium Tier 4f engine delivers superior performance and low fuel consumption. The engine features an Exhaust After Treatment System (EATS) to lower emissions and a regeneration process that does not interrupt operation, performance or productivity.



Slew and boom offset

Slew and boom offset movements are controlled simultaneously for easy and fast positioning of the machine. Joystick control enables precise, smooth and effortless command of the slew and boom offset.



Tractive force

High system pressure delivers impressive tractive force when climbing gradients or traveling over rough terrain. For improved performance, the ECR88D boasts a 16% improvement in tractive force compared to the previous model.





ENHANCED HYDRAULICS

Volvo's state-of-the-art hydraulic system is perfectly matched to the Volvo engine and components – delivering high performance and improved fuel efficiency. The hydraulic system has been designed for fast response and smooth operation.



STABILITY

Design improvements including a counterweight have shifted the center of gravity towards the rear of the machine. Together with a strong undercarriage, this delivers superior stability while lifting bigger loads.

Superior stability

If you're looking for the performance of a conventional excavator but need to work in confined areas, the Volvo ECR58D is the machine for you. With a heavy counterweight and strong undercarriage you can lift larger loads without buying a bigger machine. Volvo offers customers built-in serviceability with safe and convenient maintenance access for maximum uptime.

Service access

For safe and easy access, all service check points are located under the wide-opening engine hood and are accessed from ground level. Grouped filters ensure regular maintenance is straightforward and uptime is maximized.



Single pivot pin

Volvo uses a single pivot design that achieves maximum support between main frame and front equipment. This concept increases stability, durability and lifetime of the components.



MATRIS and VCADS Pro

For increased uptime, Volvo's high-tech, computer-based MATRIS tool allows you to monitor machine usage and analyze machine operation. VCADS Pro analysis and programming software provides fast diagnostics.



Control in comfort

The ECR58D has been expertly designed with the operator in mind. With built in safety, comfort and all-around visibility, operators will work efficiently with less fatigue in this premium environment. Capitalize on comfort and optimize your productivity with Volvo.

Climate control

Control your climate with Volvo's powerful, industry-leading climate control system. With seven well-spaced vents quickly heating or cooling the cab, this air circulation and defrosting system increases comfort and productivity.



Keypad

The majority of switches are integrated in one centralized keypad on the right-hand console. The operator can easily control the I-ECU monitor and audio system for increased comfort.



Proportional joysticks

Via the joystick controls, the operator can easily adjust the direction and amount of hydraulic flow sent to the attachment. Benefit from the correct speed and power for optimal attachment operation.



Storage

The Volvo cab features ample storage locations for personal belongings including an additional glove-box, side pocket, phone storage, cup holder and a pocket behind the seat.





VOLVO CAB

All-around visibility from slim cab pillars and large expanses of glass is at the center of Volvo's cab design. The ROPS certified cab features vibration and noise isolation, ergonomic controls and an adjustable seat for increased comfort, reduced fatigue and increased productivity.



HYDRAULIC BREAKERS

Volvo's durable hydraulic breakers have been designed for ultimate compatibility with Volvo excavators. The range has been built to break the most demanding materials and combines excellent performance with low noise and vibration levels.

Infinite opportunities

Get the most out of your compact short swing radius excavator and access more segments and applications with Volvo's comprehensive range of attachments – designed to work in perfect harmony with Volvo machines. Increase your versatility, effectively perform a variety of tasks and experience new levels of productivity with the right attachment for your specific requirements.

Interfaces

Direct fit



For maximum productivity when only operating in one application, Volvo's direct fit attachments provide the best performance and shortest tip radius.

Volvo mechanical quick coupler



Volvo's dedicated quick couplers pick up Volvo hydraulic attachments including breakers, thumbs and buckets for use in both the face shovel and normal backhoe position.

Volvo hydraulic quick coupler



Volvo's pin grabber quick coupler picks up Volvo pin-on Attachments, including breakers, thumbs and buckets for use in both the face shovel and normal position.

Buckets

General purpose buckets

The perfect tool for trenching and handling in a variety of soil conditions. Available in different widths.

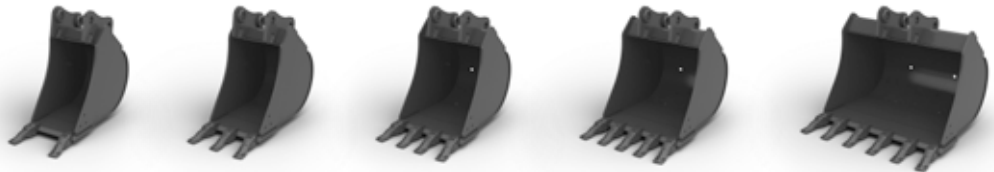

Fixed ditching buckets

Ideal for ditch cleaning, grading, landscaping and backfilling.



Tiltable ditching bucket

This bucket can be tilted 45° to each side making it a flexible and versatile solution for grading, landscaping, ditch cleaning and backfilling.



Volvo hydraulic thumb

Designed to work with both Volvo direct fit buckets and with quick coupler in various materials. Used for piling, placing, loading, lifting and carrying.

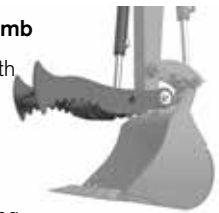

Volvo Tooth System and wear parts



General purpose

Self-sharpening, general purpose tooth with good penetration and long service life.



Twin pick

Twin pick point with sharp, dual point profile. Ideal for compact or frozen ground.



Pick point

Intended for use in extremely compact materials.



Spade nose

Designed for finishing work such as leveling, grading, cleaning and backfilling.



Bottom leg adapter

A long (one and a half) bottom leg adapter for welding to both sides of the cutting edge.



Side cutter

Side cutters ensure longer bucket life by protecting the side plates and corner welds.

Take a closer look

Auto idle

Engine speed is reduced to idle when the controls are inactive for more than five seconds or the left-hand console is raised – reducing fuel consumption and noise.

ENHANCED HYDRAULICS

The hydraulic system is perfectly matched to the engine and components for fast response and smooth operation.

Optional hydraulics

For increased versatility, auxiliary hydraulic systems are available to enable the operation of a wide range of attachments.

MATRIS and VCADS Pro

The MATRIS tool monitors machine usage and operation. VCADS Pro analysis and programming software provides fast diagnostics.

Optional dozer floating

The optional dozer blade float function 'floats' the dozer blade over the ground for improved leveling control and fuel efficiency.



VOLVO CAB

Volvo's purpose designed cab offers excellent allround viability, enhanced by the slim cab pillars and large windows.

VOLVO ENGINE

Tier 4f compliant Volvo Engine delivers superior performance with low fuel consumption.

SERVICE ACCESS

All service check points are accessed from ground level. Grouped filters make regular maintenance easy.

STABILITY

A heavy counterweight and a strong undercarriage deliver superior stability and the ability to lift bigger loads.

Single pivot pin

Volvo uses a single pivot design that achieves maximum support between main frame and front equipment, This concept increases, stability, durability and lifetime of the components

Undercarriage

Durable and strong X-shape undercarriage ensures superior stability and increases machine lifetime.

Adding value to your business

Being a Volvo customer means having a complete set of services at your fingertips. Volvo can offer you a long-term partnership, protect your revenue and provide a full range of customer solutions using high quality parts, delivered by passionate people. Volvo is committed to increasing the positive return on your investment and maximising uptime.

Complete Solutions

Volvo has the right solution for you. So why not let us provide all your needs throughout the whole life cycle of your machine? By listening to your requirements, we can reduce your total cost of ownership and increase your revenue.



Genuine Volvo Parts

Our attention to detail is what makes us stand out. This proven concept acts as a solid investment in your machine's future. Parts are extensively tested and approved because every part is vital for uptime and performance. Only by using Genuine Volvo Parts, can you be sure that your machine retains the renowned Volvo quality.

Service Network

In order to respond to your needs faster, a Volvo expert is on their way to your job site from one of our Volvo facilities. With our extensive infrastructure of technicians, workshops and dealers, Volvo has a comprehensive network to fully support you using local knowledge and global experience.







CUSTOMER SUPPORT AGREEMENTS

The range of Customer Support Agreements offer preventive maintenance, total repairs and a number of uptime services. Volvo uses the latest technology to monitor machine operation and status, giving you advice to increase your profitability. By having a Customer Support Agreement you are in control of your service costs.

Volvo ECR58D in detail

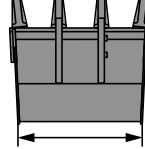
Engine		
The new Tier 4f compliant diesel engine is equipped with in-line, turbocharged and water cooled.		
Model	Volvo	D2.6H
Max. power at	r/min (r/s)	2,000 (33.3)
Net (ISO 9249/SAEJ1349)	kW (hp)	35 (47)
Gross (SAE J1995)	kW (hp)	36.5 (49)
Max. torque	Nm (ft lbf)	210 (155)
at engine speed	r/min	1,300
No. of cylinders		4
Displacement	l (in ³)	2.62 (160)
Bore	mm (in)	87 (3.42)
Stroke	mm (in)	110 (4.33)
Electrical system		
Voltage	V	12
Batteries	V	1 x 12
Battery capacity	Ah	100
Alternator	V/Ah	12/70
Starter motor output	V - kW	12 - 3
Hydraulic system		
Closed-Center Load-Sensing (CCLS) system with load independent functions.		
Main pump: Variable-displacement pump		
Maximum flow	l/min (gal/min)	1 x 126 (1 x 33.3)
Pilot pump: Gear pump		
Maximum flow	l/min (gal/min)	1 x 14 (1 x 3.7)
Relief valve setting pressure		
Implement	MPa (psi)	23.5 (3,408)
Travel circuit	MPa (psi)	23.5 (3,408)
Swing circuit	MPa (psi)	20.6 (2,988)
Pilot circuit	MPa (psi)	3.4 (493)
Swing system		
Direct drive swing with radial piston motor-maintenance free type (no reduction gear) and automatic holding brake anti-rebound valve.		
Max. swing speed	r/min	9.22
Max. swing torque	kNm (ft lbf)	13.2 (9,736)
Undercarriage		
Robust X-shaped frame with track chains.		
Track shoes		2 x 39
Link pitch	mm (in)	135 (5.3)
Shoe width - steel	mm (in)	380 / 500 (15 / 19.7)
Shoe width - rubber	mm (in)	400 (15.7)
Bottom rollers		2 x 5
Top rollers		2 x 1

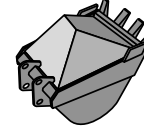
Travel System						
Each track is powered by an automatic two-speed shift travel motor. The track brakes are multi-disc, spring-applied and hydraulic released.						
Travel speed low	km/h (mi/h)	2.1 (1.3)				
Travel speed high	km/h (mi/h)	4.2 (2.6)				
Max. drawbar pull	kN (lbf)	49 (11,016)				
Gradeability	°	35				
Service Refill						
Fuel tank	l (gal)	65 (17.2)				
Hydraulic system, total	l (gal)	90 (23.8)				
Hydraulic tank	l (gal)	52 (13.7)				
Engine oil	l (gal)	11.9 (3.1)				
Engine coolant	l (gal)	8 (2.1)				
Travel reduction unit	l (gal)	2 x 1.6 (2 x 0.4)				
Cab						
Refrigerant of the type R134a is used when this machine is equipped with air conditioning. Contains fluorinated greenhouse gas R134a, Global Warming Potential 1.430 t CO ₂ -eq						
Sound Level						
Sound level in cab according to ISO 6396						
LpA (standard)	dB(A)	73				
External sound level according to ISO 6395 and EU Noise Directive 2000/14/EC						
LwA (standard)	dB(A)	97				
Buckets						
						
	Width		Weight		Capacity	
	mm	in	kg	lb	l	cu.in
Direct bucket	355	14	97	210	70	4,270
	450	18	93	210	99	6,040
	600	24	116	260	144	8,970
	750	30	131	290	190	11,590
	900	35	149	330	235	14,340
Quick coupler bucket	450	18	105	230	99	6,040
	600	24	132	290	144	8,970
	750	30	151	330	190	11,590

Specifications

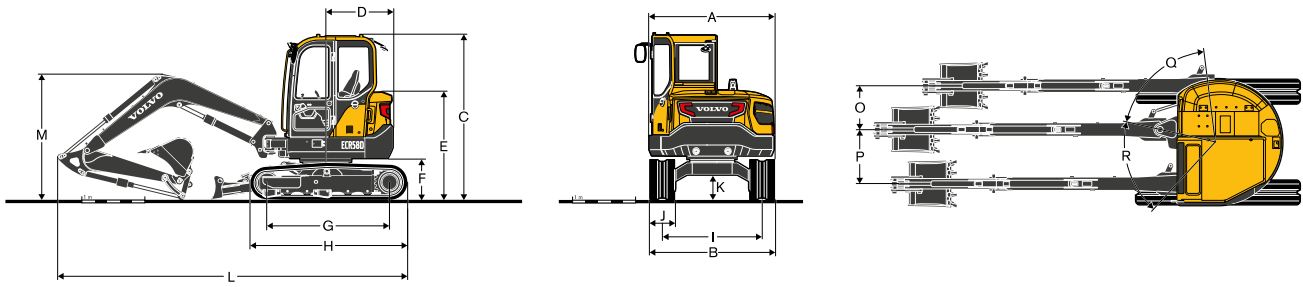

DIMENSIONS			ECR58D			
Boom	m	ft in	2.9	9'6"	2.9	9'6"
Arm	m	ft in	1.54	5'1"	1.94	6'4"
A	Overall width of upper structure	mm ft in	2 000	6'7"	2 000	6'7"
B	Overall width	mm ft in	2 000	6'7"	2 000	6'7"
C	Overall height of cab	mm ft in	2 615	8'7"	2 615	8'7"
D	Tail swing radius	mm ft in	1 060	3'6"	1 060	3'6"
E	Overall height of engine hood	mm ft in	1 710	5'7"	1 710	5'7"
F	Counterweight clearance *	mm ft in	670	2'2"	670	2'2"
G	Tumbler length	mm ft in	1 990	6'6"	1 990	6'6"
H	Track length	mm ft in	2 500	8'2"	2 500	8'2"
I	Track gauge	mm ft in	1 600	5'3"	1 600	5'3"
J	Shoe width	mm ft in	400	1'4"	400	1'4"
K	Min. ground clearance *	mm ft in	350	1'2"	350	1'2"
L	Overall length	mm ft in	5 550	18'3"	5 580	18'4"
M	Overall height of boom	mm ft in	2 000	6'7"	2 200	7'3"
O	Boom swing distance	mm ft in	695	2'3"	695	2'3"
P	Boom swing distance	mm ft in	860	2'10"	860	2'10"
Q	Boom swing angle	°		70		70
R	Boom swing angle	°		60		60

* Without shoe grouser

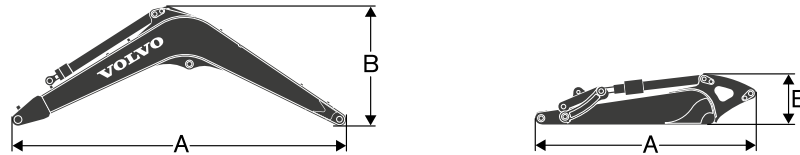

DIMENSIONS				Boom		Arm			
		m	ft in	2.9	9'6"	1.54	5'1"	1.94	6'4"
A	Length	mm	ft in	3 008	9'10"	2 023	6'8"	2 423	7'11"
B	Height	mm	ft in	1 024	3'4"	459	1'6"	473	1'7"
	Width	mm	ft in	300	1'0"	295	1'0"	295	1'0"
	Weight	kg	lb	300	660	180	400	225	500

Boom: Includes cylinder, piping and pin, excludes boom cyl. Pin. Arm: Includes cylinder, linkage and pin.

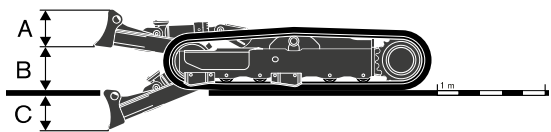

DIMENSIONS				Dozer blade			
				Standard dozer		Angle dozer	
A	Height	mm	ft in	373	1'3"	397	1'4"
	Width	mm	ft in	2 000	6'7"	2 000	6'7"
B	Lifting height	mm	ft in	423	1'5"	418	1'4"
C	Digging depth	mm	ft in	476	1'7"	616	2'0"
	Angle (Right)	°				25	
	Angle (Left)	°				25	

MACHINE WEIGHTS AND GROUND PRESSURE

	Shoe width		Operating weight		Ground pressure	
	mm	in	kg	lb	kPa	psi
Mono boom 2.9 m / 9'6", Arm 1.54 m / 5'1", Bucket 129 kg (142 l) / 280 lb, Counterweight 580 kg / 1,280 lb						
Steel track	380	15	5 858	12,915	35.2	5.1
	500	20	5 960	13,140	27.2	3.9
Rubber track	400	16	5 738	12,650	32.8	4.8
Rubber pad	400	16	5 894	12,994	33.3	4.8
Mono boom 2.9 m / 9'6", Arm 1.94 m / 6'4", Bucket 129 kg (142 l) / 280 lb, Counterweight 580 kg / 1,280 lb						
Steel track	380	15	5 918	13,047	35.5	5.1
	500	20	6 020	13,272	27.5	4.0
Rubber track	400	16	5 798	12,782	33.1	4.8
Rubber pad	400	16	5 954	13,126	33.7	4.9

Specifications

WORKING RANGES

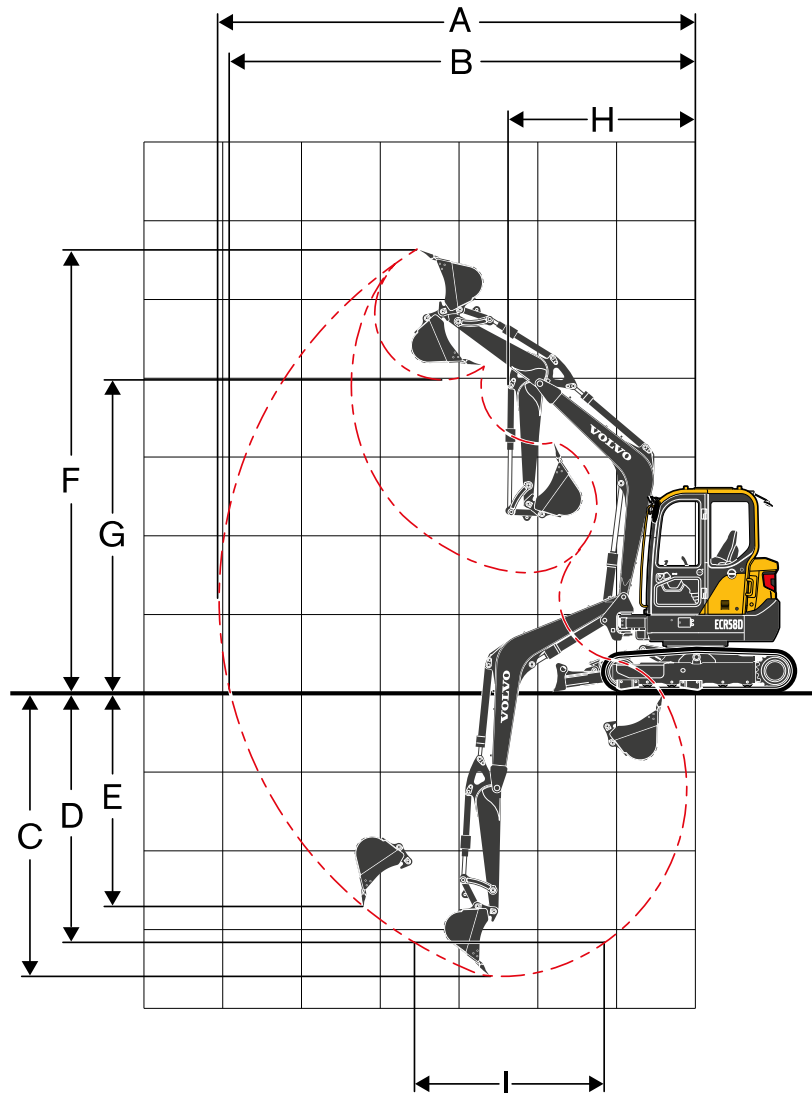

Description		Unit					
Boom		m	ft in	2.9	9'6"	2.9	9'6"
Arm		m	ft in	1.54	5'1"	1.94	6'4"
A	Max. digging reach	mm	ft in	6 000	19'8"	6 370	20'11"
B	Max. digging reach on ground	mm	ft in	5 850	19'2"	6 230	20'5"
C	Max. digging depth	mm	ft in	3 540	11'7"	3 940	12'11"
D	Max. digging depth (l=2.44m / 8' level)	mm	ft in	3 100	10'2"	3 550	11'8"
E	Max. vertical wall digging depth	mm	ft in	2 310	7'7"	2 680	8'10"
F	Max. cutting height	mm	ft in	5 570	18'3"	5 810	19'1"
G	Max. dumping height	mm	ft in	4 040	13'3"	4 280	14'1"
H	Min. front swing radius	mm	ft in	2 410	7'11"	2 450	8'0"
Digging forces with direct fit bucket							
Breakout force (bucket)	SAE J1179	kN	lb	34.6	7,780	34.6	7,780
	ISO 6015	kN	lb	39.8	8,950	39.8	8,950
Tearout force (arm)	SAE J1179	kN	lb	26.1	5,870	22.1	4,970
	ISO 6015	kN	lb	26.6	5,980	22.5	5,060
Rotation angle, bucket		°		195		195	

LIFTING CAPACITY ECR58D

Lifting capacity at the arm end without bucket.

For lifting capacity including bucket. Simply subtract actual weight of the direct fit bucket or the bucket with quick coupler from the following values.

	Lifting point		1.0 m, 3.3 ft		2.0 m, 6.6 ft		3.0 m, 9.9 ft		4.0 m, 13.2 ft		5.0 m, 16.5 ft		Max. reach					
	m	ft	kg	lb	kg	lb	kg	lb	kg	lb	kg	lb	kg	lb	ft			
			Along	Across	Along	Across	Along	Across	Along	Across	Along	Across	Along	Across	Max.			
Boom 2.9 m, 9'6" Arm 1.54 m, 5'1" Shoe 400 mm, 16" CWT 580 kg / 1,280 lb Dozer blade down	4.0								*1 110	1000			*1 130	930	4.2 m			
		13.2	lb							*2,470	2,190			*2,500	2,080	13.6 ft		
	3.0								*1 130	990			*1 100	720	4.8 m			
		9.9	lb							*2,490	2,170			*2,440	1,600	15.7 ft		
	2.0						*1 790	1490	*1 310	950	*1 120	660	*1 110	630	5.1 m			
		6.6	lb					*3,900	3,270	*2,880	2,080	*2,470	1,440	*2,460	1,400	16.8 ft		
	1.0						*2 320	1380	*1 520	900	*1 180	640	*1 130	600	5.2 m			
		3.3	lb					*5,060	3,020	*3,330	1,970	*2,590	1,400	*2,510	1,330	17.0 ft		
	0.0						*2 450	1330	*1 620	870	*1 170	630	*1 160	620	5.0 m			
		0.0	lb					*5,360	2,900	*3,540	1,900			*2,570	1,380	16.5 ft		
	-1.0			*2 460	*2 460	*3 140	2670	*2 250	1320	*1 520	860			*1 180	710	4.6 m		
		-3.3	lb	*5,440	*5,440	*7,000	5,830	*4,930	2,900	*3,310	1,890			*2,610	1,580	15.0 ft		
	-2.0					*2 590	*2 590	*1 680	1360					*1 140	970	3.8 m		
	-6.6	lb			*5,650	*5,650	*3,660	2,970					*2,520	2,170	12.3 ft			
Boom 2.9 m, 9'6" Arm 1.54 m, 5'1" Shoe 400 mm, 16" CWT 580 kg / 1,280 lb Dozer blade up	4.0								*1 110	940			*1 130	880	4.2 m			
		13.2	lb							*2,470	2,060			*2,500	1,960	13.6 ft		
	3.0								*1 130	930			930	680	4.8 m			
		9.9	lb							*2,490	2,040			2,050	1,500	15.7 ft		
	2.0						*1 790	1400	1220	890	850	620	820	590	5.1 m			
		6.6	lb					*3,900	3,070	2,670	1,950	1,860	1,350	1,810	1,310	16.8 ft		
	1.0						1810	1290	1170	840	830	600	780	560	5.2 m			
		3.3	lb					3,960	2,820	2,560	1,850	1,820	1,310	1,740	1,250	17.0 ft		
	0.0						1760	1240	1130	810	820	590	810	580	5.0 m			
		0.0	lb					3,840	2,710	2,480	1,780			1,800	1,290	16.5 ft		
	-1.0			*2 460	*2 460	*3 140	2460	1750	1230	1130	800			930	670	4.6 m		
		-3.3	lb	*5,440	*5,440	*7,000	5,380	3,840	2,700	2,470	1,760			2,060	1,470	15 ft		
	-2.0					*2 590	2520	*1 680	1270					*1 140	910	3.8 m		
	-6.6	lb			*5,650	5,510	*3,660	2,780					*2,520	2,030	12.3 ft			
Boom 2.9 m, 9'6" Arm 1.94 m, 6'4" Shoe 400 mm, 16" CWT 580 kg / 1,280 lb Dozer blade down	5.0												*1 050	*1 050	3.6 m			
		16.5	lb											*2,340	*2,340	11.7 ft		
	4.0								*910	*910				*960	780	4.6 m		
		13.2	lb							*2,030	*2,030				*2,120	1,730	15.2 ft	
	3.0								*970	*970	*960	680		*910	620	5.2 m		
		9.9	lb							*2,150	*2,150	*2,130	1,480		*2,000	1,380	17.1 ft	
	2.0						*1 490	*1 490	*1 170	960	*1 020	660	*910	550	5.5 m			
		6.6	lb					*3,260	*3,260	*2,570	2,090	*2,250	1,440	*2,020	1,220	18.0 ft		
	1.0						*2 090	1370	*1 400	890	*1 110	630	*970	530	5.6 m			
		3.3	lb					4,560	3,010	*3,080	1,950	*2,440	1,380	*2,150	1,170	18.3 ft		
	0.0					*1 500	*1 500	*2 370	1280	*1 560	840	*1 160	610	*1 040	540	5.4 m		
		0.0	lb					*3,350	*3,350	*5,190	2,810	*3,410	1,850	*2,550	1,330	*2,290	1,190	17.8 ft
	-1.0			*1 960	*1 960	*2 680	2530	*2 310	1260	*1 550	820	*1 080	600	*1 070	600	5.0 m		
		-3.3	lb	*4,330	*4,330	*5,980	5,520	*5,060	2,770	*3,380	1,810			*2,360	1,330	16.5 ft		
	-2.0			*3 090	*3 090	*3 180	2590	*1 920	1290	*1 260	840			*1 070	770	4.3 m		
		-6.6	lb	*6,870	*6,870	*6,920	5,660	*4,190	2,820	*2,730	1,850			*2,370	1,700	14.1 ft		
	-3.0					*1 450	*1 450							*890	*890	2.9 m		
	-9.9	lb			*3,080	*3,080							*1,940	*1,940	9.5 ft			
Boom 2.9 m, 9'6" Arm 1.94 m, 6'4" Shoe 400 mm, 16" CWT 580 kg / 1,280 lb Dozer blade down	5.0												*1 050	*1 050	3.6 m			
		16.5	lb											*2,340	*2,340	11.7 ft		
	4.0								*910	*910				*960	730	4.6 m		
		13.2	lb							*2,030	*2,030				*2,120	1,630	15.2 ft	
	3.0								*970	950	870	630		810	580	5.2 m		
		9.9	lb							*2,150	2,080	1,910	1,390	1,790	1,300	17.1 ft		
	2.0						*1 490	1430	*1 170	900	850	620	720	520	5.5 m			
		6.6	lb					*3,260	3,140	*2,570	1,970	1,860	1,350	1,600	1,140	18.0 ft		
	1.0						1810	1280	1160	830	820	590	690	490	5.6 m			
		3.3	lb					3,960	2,810	2,540	1,830	1,800	1,290	1,530	1,090	18.3 ft		
	0.0					*1 500	*1 500	1710	1190	1110	790	800	560	710	500	5.4 m		
		0.0	lb					*3,350	*3,350	3,750	2,620	2,430	1,720	1,750	1,240	1,570	1,110	17.8 ft
	-1.0			*1 960	*1 960	*2 680	2320	1690	1170	1090	770	800	560	790	560	5.0 m		
		-3.3	lb	*4,330	*4,330	*5,980	5,070	3,700	2,570	2,390	1,680			1,750	1,240	16.5 ft		
	-2.0			*3 090	*3 090	*3 180	2390	1720	1200	1110	790			1010	710	4.3 m		
		-6.6	lb	*6,870	*6,870	*6,920	5,210	3,760	2,620	2,430	1,720			2,230	1,590	14.1 ft		
	-3.0					*1 450	*1 450							*890	*890	2.9 m		
	-9.9	lb			*3,080	*3,080							*1,940	*1,940	9.5 ft			

1. The above loads are in compliance with SAE J1097 and ISO 10567 Hydraulic Excavator Lifting Capacity Standards.

Notes:

2. Rated loads do not exceed 87% of hydraulic lifting capacity or 75% of tipping load.

3. Rated loads marked with an asterisk (*) are limited by hydraulic capacity rather than tipping load.

Equipment

STANDARD EQUIPMENT

Engine

Low-emission Volvo T4f diesel engine
Standard cooling system
Two-stage air filter
Fuel filter and water separator
Alternator, 70 A

Electric / Electronic control system

Safe engine start function
Safe engine start function
Automatic idling system
Halogen working lights:
Cab-mounted 2 (front)
Battery, 12 V / 100 Ah
Start motor, 12 V / 3 kW
Travel alarm
Monitor and keypad
Master electrical disconnect switch

Frame

580 kg (1,280 lb) counterweight
Under cover
Dozer blade

Undercarriage

Track link
400 mm (16") rubber track

Hydraulic system

Automatic two speed travel motors
Cylinder cushioning
Hydraulic fluid mineral 46
Pilot control pattern change

Cab and interior

Canopy
PVC operator seat with suspension
Seat belt, 2 inch retractable
Control joystick
Master key
Hour meter (non analog)

Digging Equipment

Boom: 2.9 m (9'6"), Arm: 1.54 m (5'1")
Linkage

Service

Tool kit-daily maintenance

Official approval

Object handling device conforming to ISO 20474-1 and ISO 20474-5 standards (when equipped)
FOPS Level 2 conforming to ISO 3449 standard (when equipped)
ROPS conforming to ISO 12117-2 standards
TOPS conforming to ISO 12117 and EN13531 standards
FOG Level 2 conforming to ISO 10262 standard and SAE J1356 standard (when equipped)

OPTIONAL EQUIPMENT

Electric / Electronic control system

Fuel filler pump: 35 l/min (9 gpm), with automatic shut-off
Extra working lights:
Cab-mounted 1 (rear), Boom-mounted 1
Caretrack
Anti theft, code-lock
Rotating warning beacon

Frame

Rearview mirror
Dozer blade with floating function
Angle dozer blade

Undercarriage

380 mm (15"), 500 mm (20") steel track
400 mm (16") rubber pad
Heavy counterweight

Hydraulic system

Hydraulic piping:
Breaker & shear (max. flow and pressure: 70 lpm / 18 gpm, 26.5 Mpa / 3,840 psi)
Slope & rotator (max. flow and pressure: 35 lpm / 9 gpm, 14.7 Mpa / 2,130 psi)
Grapple
Quick coupler
Hose rupture valve for boom and arm
Overload warning device
Hydraulic oil, ISO VG 32, 68
Hydraulic oil, biodegradable 46
Hydraulic oil, longlife oil 46

Cab and interior

Cab
Carecab
Fabric operator seat with suspension
Heater and air-conditioner
Control joystick, X3 proportional
Seat belt, 3 inch retractable
AM/FM stereo
AM/FM stereo with CD player and USB input
Mechanical hour meter
Cab mounted FOG (Falling Object Guard)
FOPS (Falling Object Protection Structure)
Sun screen, front/roof
Safety net

Digging Equipment

Arm: 1.94 m (6'4")

Service

Tool kit, full scale
Spare parts

SELECTION OF VOLVO OPTIONAL EQUIPMENT

Slope and rotator piping



Dozer float



Caretrack



Angle dozer blade



Mechanical hour meter



Anti-theft

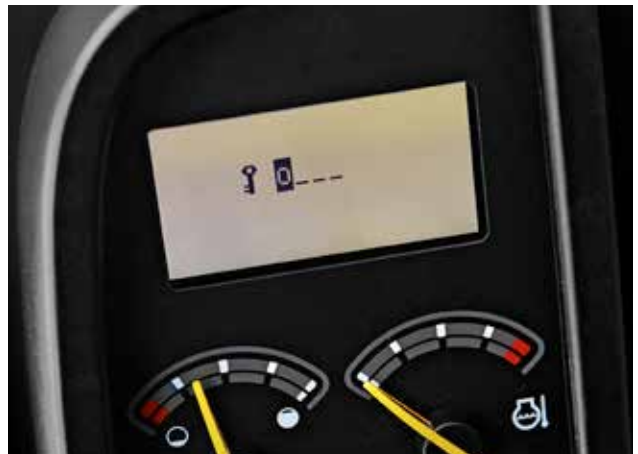

Not all products are available in all markets. Under our policy of continuous improvement, we reserve the right to change specifications and design without prior notice. The illustrations do not necessarily show the standard version of the machine.

VOLVO

Volvo Construction Equipment

www.volvoce.com