

**BUILT FOR MAXIMUM  
POWER, PERFORMANCE  
AND RELIABILITY**



**VOLVO**

# RELY ON VOLVO GRADERS FOR EVERY JOB

Since we put the first graders on the road in 1875, Volvo has been building and backing the toughest machines on the job site. We have combined our extensive experience in motor graders with today's advanced design technology to build the most productive and reliable graders in the industry.

Every detail on Volvo Graders, from the advanced cab design, to job matched transmission speeds, to a power-to-weight ratio that maximizes blade down pressure and blade pull, has been optimized to boost your productivity, improve versatility and deliver superior operator comfort.

The Volvo team stands behind every grader we build with a worldwide parts and service support network – qualified grader professionals who have earned the reputation of being “The Grader Experts”.

Whether you're building a road, cutting a ditch, fine grading, or cleaning up after a snowstorm, there's a Volvo Grader for every job.

## 700 Models - Every Environment, Every Job

Rugged and dependable, you can find Volvo tandem drive 700 Models hard at work around the world on the most demanding assignments. 700 Models are popular with private contractors, road builders, logging companies and municipal governments for their power, blade control, speed, durability and versatility. With an unmatched range of standard features and options, there's a Volvo Grader built for your application.

## 700 AWD Models - Precise, Powerful All Wheel Drive

These AWD Models feature the industry's most advanced and reliable All Wheel Drive System for more productive grading in any working conditions. Not only does this system distribute power more evenly than conventional systems, the Volvo revolutionary Creep Mode allows you to disengage the rear wheels and operate in front wheel drive for extremely precise, low speed fine grading.

## Compact Models - Large Grader Features

Volvo put the power and precision of an advanced hydrostatic drive to work in the most productive compact grader line in the industry. By incorporating a wide range of large grader features, Volvo Compact Models do big grader work in areas big graders can't go.



Add power and precision to any grading job with up to 7,500 lb (3 400 kg) more blade pull and exclusive Creep Mode – the unique ability to switch to independent hydrostatic front wheel drive for fine grading.



Weight Range	31,620 - 35,730 lb 14 343 - 16 208 kg
Horsepower	160 - 200 hp 119 - 149 kW

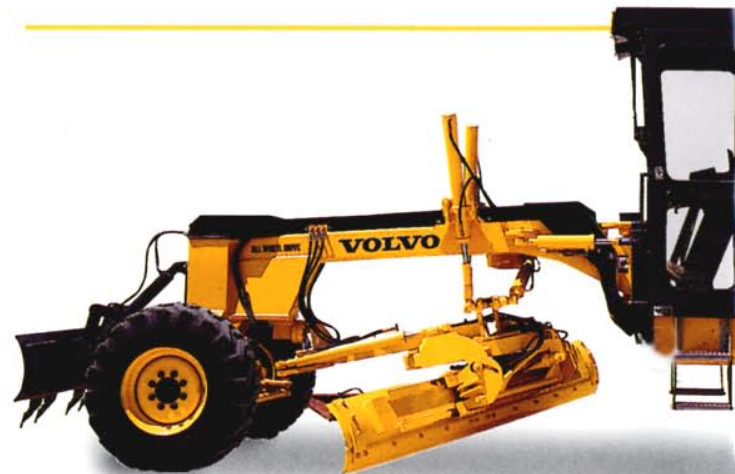



# 700

MODELS



700 Models are the workhorses of job sites around the world – plowing snow, fine grading, building roads, ripping and scarifying – everything you expect from a grader, all day, every day.

Weight Range	30,630 - 42,740 lb 13 894 - 19 388 kg
Horsepower	140 - 235 hp 104 - 175 kW

# 700AWD

MODELS



# COMPACT

MODELS



Compact Models offer unbeatable maneuverability, performance and productivity. With available All Wheel Drive Models and 9 different attachments, Volvo Compact Graders are versatile enough to handle a wide range of tasks.

Weight Range	12,800 - 15,500 lb 5 810 - 7 030 kg
Horsepower	85 - 110 hp 63 - 82 kW

# A NEW LEVEL OF PRODUCTIVITY AND RELIABILITY

## 1 More Power Where You Need It

Volvo Graders are powered by reliable engines for superior lugging power and low emissions. More engine power is delivered to the ground through the industry's most efficient drivetrain, featuring the direct drive 8400 transmission and lock/unlock final drives.

## 2 Superior Blade Versatility and Control

The Moveable Blade Control System (MBCS) allows the operator to accurately position the blade on either side of the grader at any angle up to 90° for bank sloping and to 21° downward for ditching, making it easy to cut the exact profile you need. With excellent lift above ground, deepest cut below ground and the farthest reach outside the tire profile, you can cut, clean and ditch with maximum stability in the fewest possible passes.

## 3 A Better Place to Work

We take pride in doing more for the operator. Volvo offers a wide range of comfort and control features that no

other grader can match. Improved 360° visibility, an advanced climate control system and the fully adjustable steering pedestal help the operator be more productive and help reduce fatigue over long days.

## 4 Precise, Powerful – All Wheel Drive

Volvo revolutionizes grader all wheel drive with an advanced system that delivers independent hydraulic power to each front wheel for even power distribution through turns and in terrain where traction is an issue. The Volvo All Wheel Drive System gives you the ability to handle every task, from high speed snow plowing to hydrostatic Creep Mode for low speed fine grading applications.

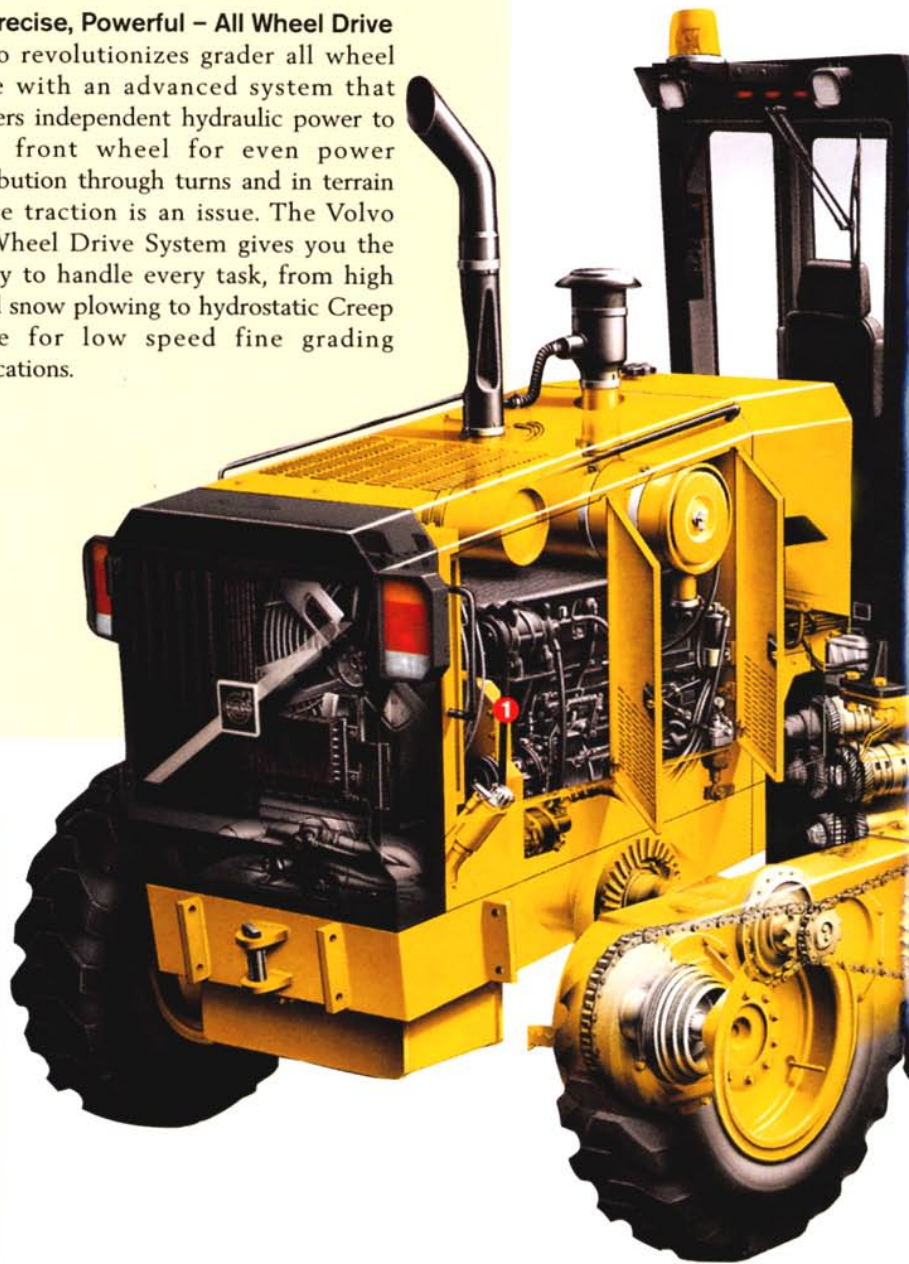

G740 VHP Drawbar Pull

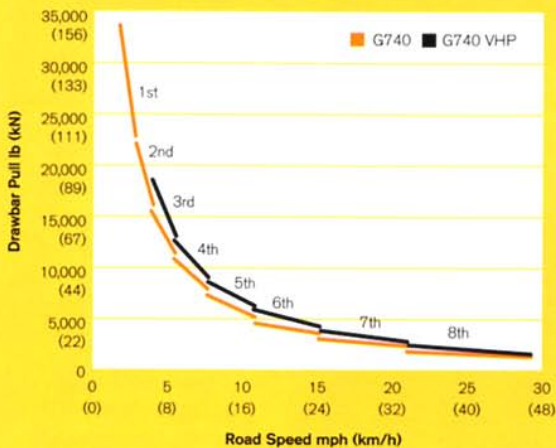

VHP Models deliver a substantial increase in drawbar pull in gears 3 through 8.

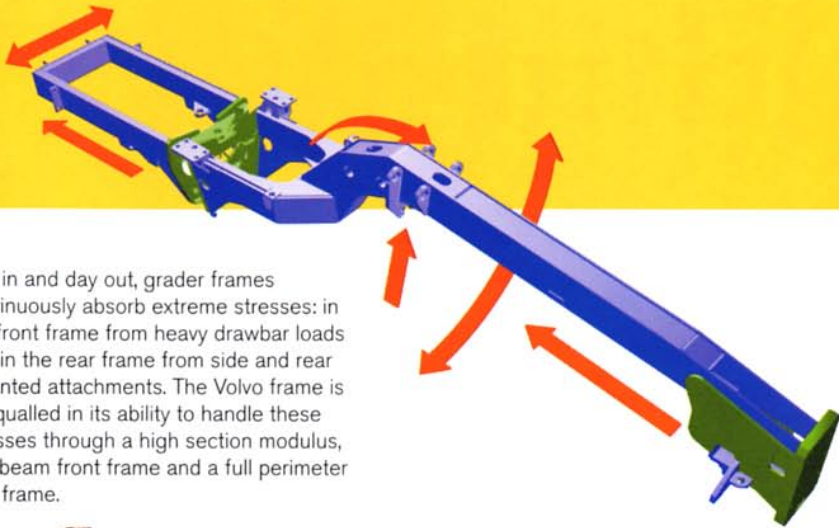

Day in and day out, grader frames continuously absorb extreme stresses: in the front frame from heavy drawbar loads and in the rear frame from side and rear mounted attachments. The Volvo frame is unequalled in its ability to handle these stresses through a high section modulus, box beam front frame and a full perimeter rear frame.



Designed with the operator in mind, a wide range of standard features and options lets you customize your environment for maximum productivity and operator comfort.



More power is put behind the blade by balancing front to rear weight ratios with the longest blade base in the industry.



The revolutionary All Wheel Drive System sets a new standard – it's both powerful enough for high speed snow clearing and precise enough to meet the fine grading tolerances that road builders demand.

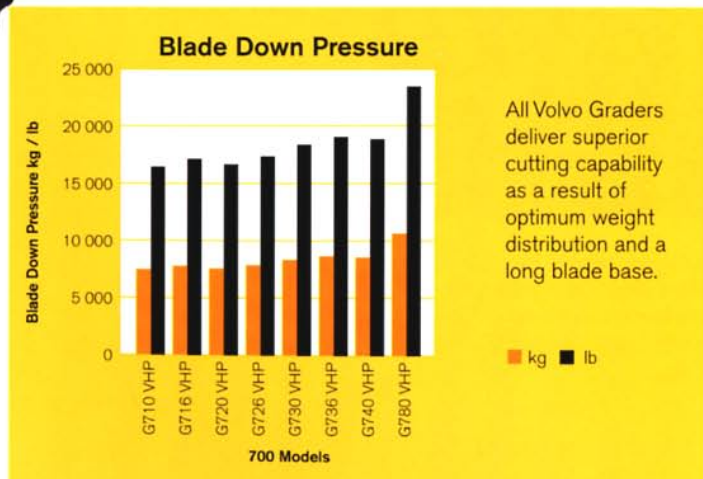

All Volvo Graders deliver superior cutting capability as a result of optimum weight distribution and a long blade base.

# MORE POWER WHERE YOU NEED IT

## 700 MODELS

With the most advanced and efficient powertrain in the industry, Volvo Graders deliver more engine power to the ground – adding blade pull, speed and performance to every grading job.

- High torque engines, available in either Variable Horsepower or standard power models, deliver up to 53% net torque rise for maximum high load performance.
- Rugged and reliable, the Volvo 8400 transmissions have been proven in millions of hours of operation. Evenly proportioned gear ratios deliver the exact power and speed you need to match every grading job.
- Lock/unlock differential final drives complete the package with simplicity and strength.

### Superior Blade Pull

Our blade pull is legendary in motor grading. By optimizing weight placement over the drive wheels and over a long blade base and by putting more engine power to the ground, Volvo Graders offer blade pull capability that leads the industry in every weight class.

### Robust and Reliable

You need to know you can rely on your grader to perform with maximum reliability. Volvo componentry has been designed to deliver thousands of hours of trouble free operation, because you put your grader through its paces every day.



Cabinet style doors on the engine cowling make on site maintenance convenient by providing fast and easy access to all regular maintenance points.



The 8400 fully sequential, direct drive, powershift transmission offers eight forward and four reverse evenly stepped speeds to match any job up to 27.9 mph (44,8 km/h).

There's no replacement for the right combination of weight and horsepower. Volvo Graders offer precisely matched horsepower-to-weight ratios for maximum machine productivity in any application.



## COMPACT MODELS

Agile and powerful, Volvo Compact Models feature a rugged hydrostatic drive system that delivers the precise speed control and power needed for a wide variety of grading applications.

### Performance Innovations

Compact Model features include industry standard blade controls with twin flow hydraulics, a choice of either foot or hand operated travel controls and a full range of attachments. When it comes to performance no other compact grader comes close.



Compact Models allow easy access to the powertrain for fast on site maintenance.



All Wheel Drive is available on two Compact Models (G66 and G86) for added traction and control in poor conditions.

### Net Torque Rise

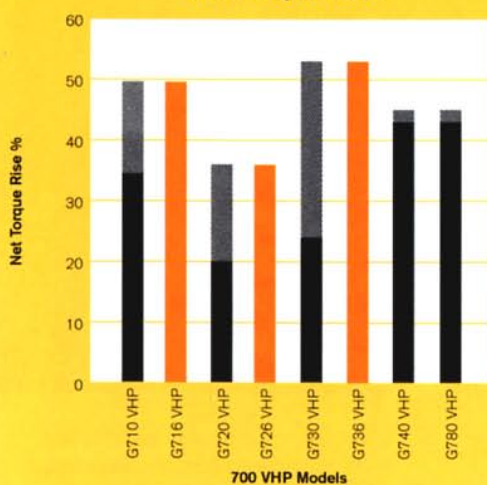

Net torque rise – the measure of the engine's ability to sustain power under load. Volvo Graders offer the highest net torque rise in the industry.

■ AWD On - All Gears  
■ Gears 3-8  
■ Gears 1 & 2

# SUPERIOR BLADE CONTROL

**700**  
MODELS

No other grader gives you the blade mobility, stability or reach of Volvo Graders. Three systems – the MBCS (Moveable Blade Control System), Circle Turn System and Blade Lift System – work together to help you achieve the required profile and reduce the number of passes required to handle material accurately and efficiently.

## Mobility and Stability

MBCS allows the operator to set the blade at any angle up to a full 90° vertically on both sides of the grader, as well as a 21° downward angle for ditch cutting. You can cut a 2:1 bank slope with the moldboard completely outside of the tire profile. The blade can be set safely and easily at any required angle simply by repositioning the MBCS lockbar to any one of seven available positions.

For superior blade stability, the parallel Blade Lift cylinders have the widest stance in the industry to reduce end to end moldboard corrections when fine grading.

The circle turn pinions are driven by dual direct acting hydraulic cylinders for maximum turning power. These two points of leverage allow the operator to hold even the heaviest load for increased pushing capability. The Circle Turn System is protected by an overload relief valve.

## Precise Controls

The Volvo Blade Control System receives hydraulic power through a load sensing, closed center hydraulic system with feathering capability for precise blade handling.

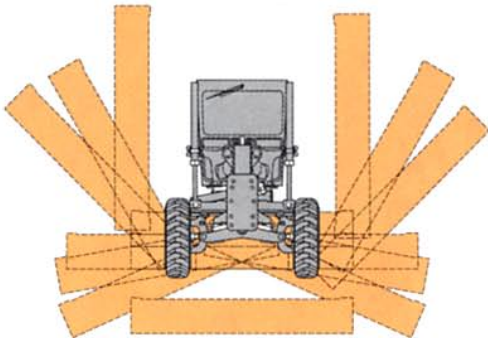

The MBCS gives you the flexibility to position the blade at any angle you need for shouldering, slope work and ditch cleaning – up to 90° upward and 21° downward.



Volvo Graders have the industry's longest blade reach outside the tire profile, reducing the number of passes you need to make and increasing your productivity.

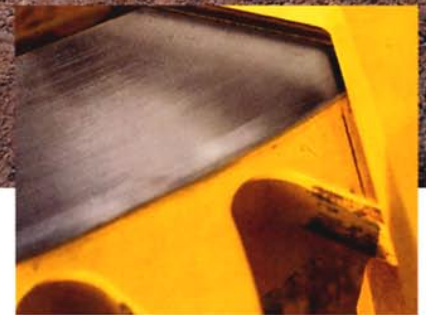

Duramide™ bearing material eliminates metal-to-metal contact and reduces the need for Circle Turn lubrication and adjustment. It has a service life of more than 5,000 hours and is simple and cost effective to replace.





**COMPACT  
MODELS**

Volvo Compact Models feature a simple, robust, trunnion mounted Blade Lift System, with a precise, dual cylinder, direct acting Circle Turn System. Hydraulic control features include detent style float valves and optional twin flow hydraulics.

The result is a level of blade mobility, precision and reach that was previously unavailable on compact graders. Whether it's pushing and cutting, attachment work or fine grading, these Models are well equipped to handle all types of work.



Optimum blade range and a tight turning circle allow Volvo Compact Graders to complete a variety of tasks in close quarters.



- 1. The MBCS controls the moldboard angle relative to the ground.
- 2. The twin cylinder Circle Turn System controls the rotation of the moldboard.
- 3. The Blade Lift System raises the moldboard to a height of 17.5" (445 mm) and lowers it to a maximum cutting depth of 33" (838 mm).



Doing more for less: by building the versatility of our large graders into our Compact Models, Volvo offers an easy to use alternative for a wide range of jobs and a fast return on your investment.

# A BETTER PLACE TO WORK

## 700 MODELS

A grader is only as productive as the operator. For that reason, Volvo takes pride in providing an operator environment that is recognized for its comfort and functionality.

In designing the operator environment, we talked to customers around the world to find out what they needed in order to reduce operator fatigue and increase productivity. The result is a cab that is quieter and more comfortable, with excellent climate control, convenient operating controls and 360° visibility.

### Superior Visibility

Because you operate your grader on or near public roads, in tight areas and around other equipment, the sloped front frame and rear cowling are designed to open up your line of sight. The Volvo cab offers a 360° view around the grader to watch the road and attachments, a clear view down to the blade area, and an unobstructed view around the front wheels.

### Built for Productivity

All of the operator controls are conveniently located within a 90° arc, either in the fully adjustable steering pedestal or in the right hand console. Added touches, like side and lower front opening windows and an operator convenience package, put the operator's comfort first.

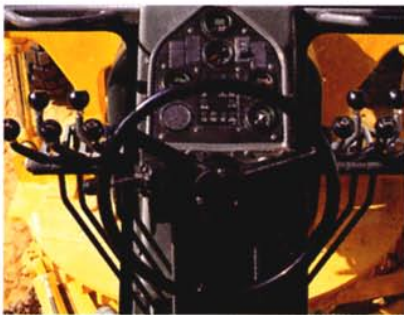
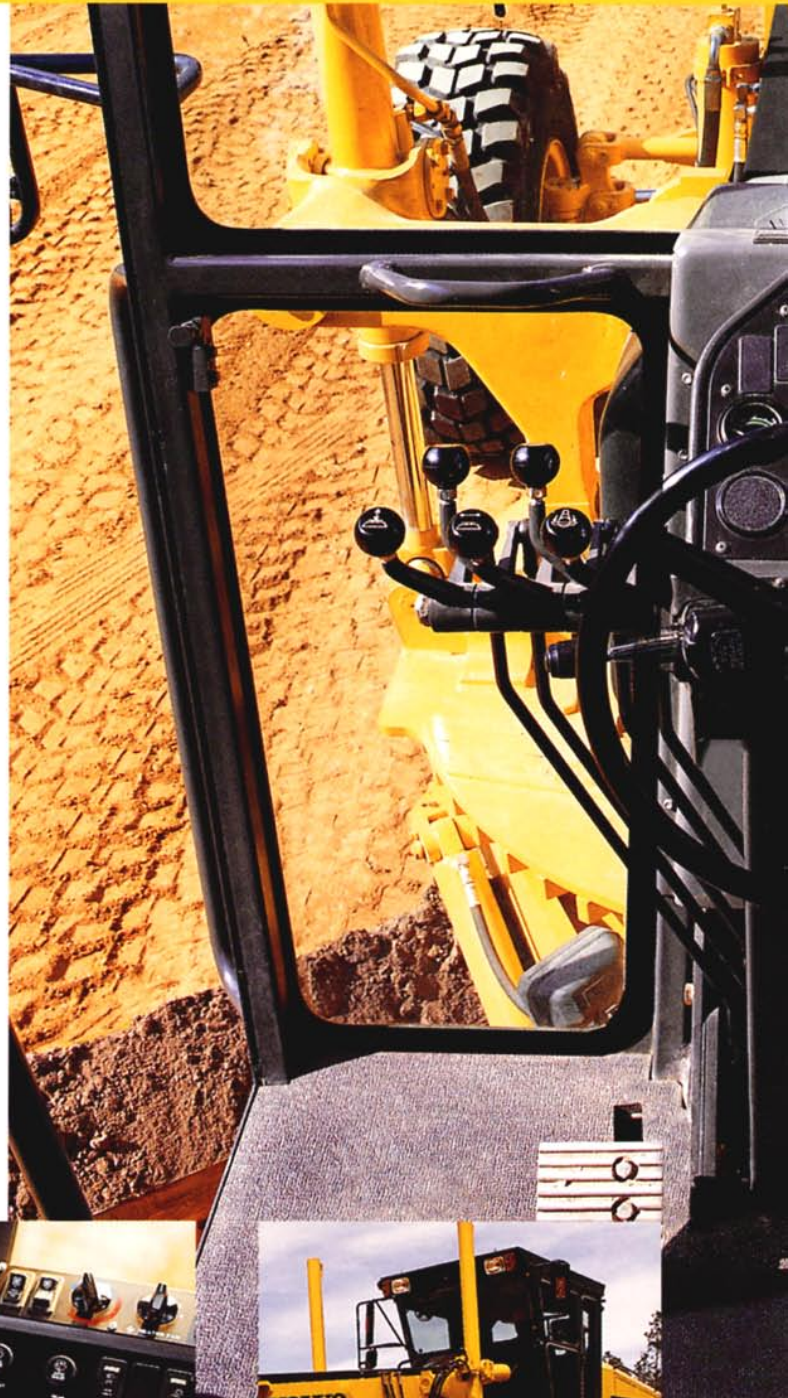

The steering pedestal features industry standard short throw hydraulic controls, the machine monitoring module and all necessary gauges.



In the right hand console you'll find the electrical switches, circuit breakers, climate controls, engine start and the "Smart Shifter" transmission controller - which allows you to customize shift patterns for faster cycle times.



The Volvo cab is available in either full height or low profile configurations and features an HVAC climate control system that provides superior operator comfort in all weather conditions.



With larger windows and a narrow steering pedestal, you get a clear view of the moldboard and the areas around your grader. This improved visibility gives you the confidence to maneuver in congested areas and to work with greater accuracy.

## COMPACT MODELS

Because smaller jobs don't mean shorter workdays, we've designed the cab on Volvo Compact Models to be the most functional and productive in their class. Choose between a canopy or a fully enclosed cab that offers many of the same features found on our 700 Models. Both choices include Internal Roll Over Protective Structure (ROPS).

Compact Models also feature an adjustable steering pedestal and twin flow hydraulics, plus dual lever speed and directional controls for easy operation of the hydrostatic transmission.



For improved comfort and visibility, the control pedestal and window space on Compact Models is similar to the design we feature on the large Volvo Graders.



For reduced cycle times and increased grading precision around tight corners, Volvo Compact Graders have a turning radius of only 16'6" (5 029 mm).

# PRECISE, POWERFUL - ALL WHEEL DRIVE

## 700 MODELS

700 AWD Models feature a revolutionary All Wheel Drive System that delivers maximum power with maximum precision.

Whatever your application, the system is tuned to the task. The AWD System provides even distribution of power through independent variable displacement pumps and high torque motors at each front wheel. If the traction differs on either side, this system ensures that optimum pulling power is still achieved.

Speed sensors on each front wheel control the relative front to rear speeds. The main AWD control features 16 levels of aggression to the front wheels.

### Leading All Wheel Drive Innovation

Only Volvo AWD Graders offer you the ability to switch to Creep Mode for low speed, fine grading applications. Creep Mode disengages the rear drive and pulls the grader in hydrostatic front wheel drive only. This puts the power where it needs to be for fine grading and allows the moldboard to be navigated around the tightest corners without the rear wheels "scuffing" the finished grade.

### Unbeatable High Speed Operation

Only 700 AWD Models work up to 20.2 mph (32,5 km/h) for optimum snow clearing performance. This innovative AWD System is available in Models G716 VHP, G726 VHP and G736 VHP.



Infinite speed selection from 0-2.0 mph (0-3,2 km/h), made available by our innovative Creep Mode enables you to match your speed to the fine grading job at hand.



700 AWD Model Graders feature the industry's heaviest front end, optimizing traction up front and increasing both blade down pressure and blade pull capability.



Not only do 700 AWD Models deliver up to 7,500 lb (3 400 kg) more blade pull to your heavy applications, the low speed Creep Mode adds extreme precision to your fine grading applications.



With a separate hydraulic pump driving an independent motor at each front wheel, the unique Volvo All Wheel Drive System distributes power evenly, efficiently and reliably.



The controls for the AWD System – the AWD On/Off switch, 16 position aggression setting dial, Creep Mode activation switch and audible/visual AWD System Monitoring System, are conveniently located at the operator's right hand.



Creep Mode helps you grade within the tightest tolerances in a single pass, without damage to the fine grade.

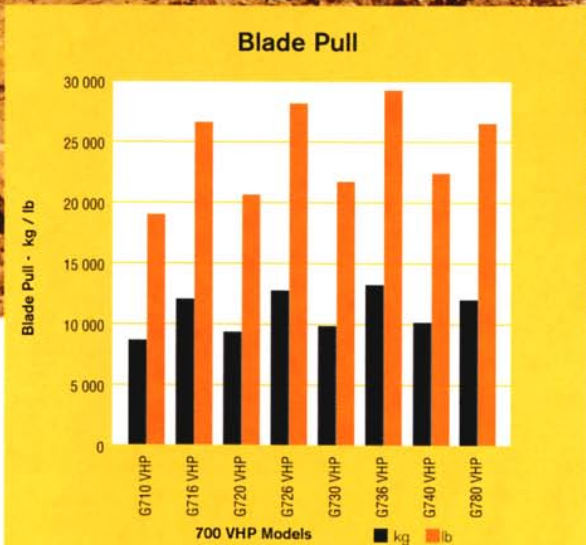

Volvo tandem drive and All Wheel Drive Models deliver the industry's highest blade pull in every weight class.

# CHOOSE YOUR VOLVO GRADER

Volvo offers the widest range of machine sizes and grader attachments in the industry. Whether you need a maintainer for a specific task, or a reliable, all purpose machine, there's a model that meets your needs. All Volvo Graders have a long list of standard features, options and attachments no other grader company can match.

## Machine Specification Chart

Use the chart below to help you choose the model you need. By taking into account your applications, terrain and climate, your dealer will put together a grader package that serves you best.



All Volvo Motor Graders are easily fitted with Automatic Blade Control systems for fast and precise fine grading





Model	Base Weight lb (kg)	Net Power hp (kW) @ rpm	Landscaping	Subdivision Parking Lots	Shoulder Maintenance	Road Maintenance	Road Building	Snow Removal	Forestry	Quarry
Compact	<b>G60</b>	12,800 (5 810)	85 (63) @ 2500							
	<b>G66</b>	13,400 (6 080)	85 (63) @ 2500							
	<b>G80</b>	15,000 (6 800)	85 (63) @ 2500							
	<b>G86</b>	15,500 (7 030)	110 (82) @ 2500							
700	<b>G710</b>	30,630 (13 894)	140 (104) @ 2200							
	<b>G710 VHP</b>	30,630 (13 894)	135-160 (101-119) @ 2200							
	<b>G720</b>	32,570 (14 775)	160 (119) @ 2200							
	<b>G720 VHP</b>	32,570 (14 775)	170-195 (127-145) @ 2200							
	<b>G730</b>	34,750 (15 763)	195 (145) @ 2200							
	<b>G730 VHP</b>	34,750 (15 763)	180-200(134-149) @ 2200							
	<b>G740</b>	35,610 (16 153)	210 (157) @ 2100							
	<b>G740 VHP</b>	35,610 (16 153)	210-235(157-175) @ 2100							
	<b>G780</b>	42,740 (19 388)	210 (157) @ 2100							
	<b>G780 VHP</b>	42,740 (19 388)	210-235(157-175) @ 2100							
700 AWD	<b>G716 VHP</b>	31,620 (14 343)	135-160 (101-119) @ 2200							
	<b>G726 VHP</b>	33,550 (15 218)	170-195 (127-145) @ 2200							
	<b>G736 VHP</b>	35,730 (16 208)	180-200 (134-149) @ 2200							



# 700

MODELS

# 700<sup>AWD</sup>

MODELS

<p>G710 / G710 VHP</p> 	<p>G720 / G720 VHP</p> 
<p>G730 / G730 VHP</p> 	<p>G740 / G740 VHP</p> 
<p>G780 / G780 VHP</p> 	

<p>G716 VHP</p> 	<p>G726 VHP</p> 
<p>G736 VHP</p> 	

## 700 / 700AWD MODEL ATTACHMENTS



\*A\* Frame with integral hydraulics for front mounted attachments.



Dozer Blade for bulk leveling, back filling and clean up.



\*V\* Plow – especially effective for breaking open snow clogged roads.



Rear Snow Wings in cable lift and all hydraulic configurations mount directly to the grader frame for maximum control and strength.



Push Block bolts to nose plate for pushing other equipment and counterbalances the rear ripper.



Scarifier mounts behind front axle for improved scarifier down pressure.



One Way Plow – specifically designed for high speed snow dispersal.



Ripper/Scarifier attached directly to the rear frame for tearing of the hardest surfaces.



Windrow Eliminator facilitates rapid, efficient and safe shoulder maintenance in fewer passes.







Front Snow Wings mount directly to the grader front frame section for maximum maneuverability and visibility.

# COMPACT

## MODELS



<p>G60</p> 	<p>G66</p> 
<p>G80</p> 	<p>G86</p> 

### COMPACT MODEL ATTACHMENTS



Counter Weight - attached to the nose plate, provides a counterbalance for rear mounted attachments.



"V" Scarifier for breaking up compacted soil, aggregates and hard surfaces.



Broom for rapid clean up of intersections, aggregate removal from sealed surfaces and final clean up after asphaltting.



Automatic Blade Control System achieves and maintains pre-set grade and adjusts for grade changes. Ideal for site preparation.



Side Dozer for clearing to the side of the machine, pushing material under guard rails and discarding extra material.



Loader - fewer machines are needed for site clean up and clearing. Lift height sufficient for tandem dump truck.



Rippifier - ideal for loosening hard packed aggregates.



Dozer/Scarifier for on site utility. Ideal for construction site preparation. Lift up scarifier teeth.



Windrow Eliminator facilitates rapid, efficient and safe shoulder maintenance in fewer passes.





# AROUND THE WORLD, AROUND THE CLOCK

No matter where you are located, you can rely on genuine Volvo Parts and Service to keep your graders running at maximum productivity day after day. Our parts availability and service expertise are second to none in the industry.

## Parts Support

Genuine Volvo and Champion parts are manufactured to the most stringent specifications, guaranteeing compatibility, superior performance and a long service life. To make sure you never have to settle for less than the best, your local dealer carries a complete inventory of parts for your Champion or Volvo Grader.

## Service and Support

When you're backed by Volvo, your Volvo or Champion Grader is backed by thousands of skilled parts and service people in 96 countries. Together, we cover the globe. We also offer a full range of warranties and extended service plans to meet your needs.



Only by maintaining your grader with original, factory approved Volvo or Champion parts, are you guaranteed reliability and performance that matches your grader's original specifications.

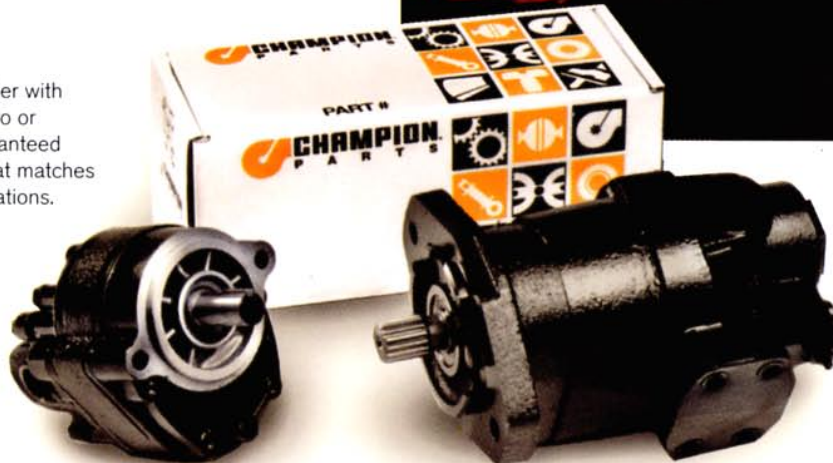

# WE SUPPORT YOUR GRADER

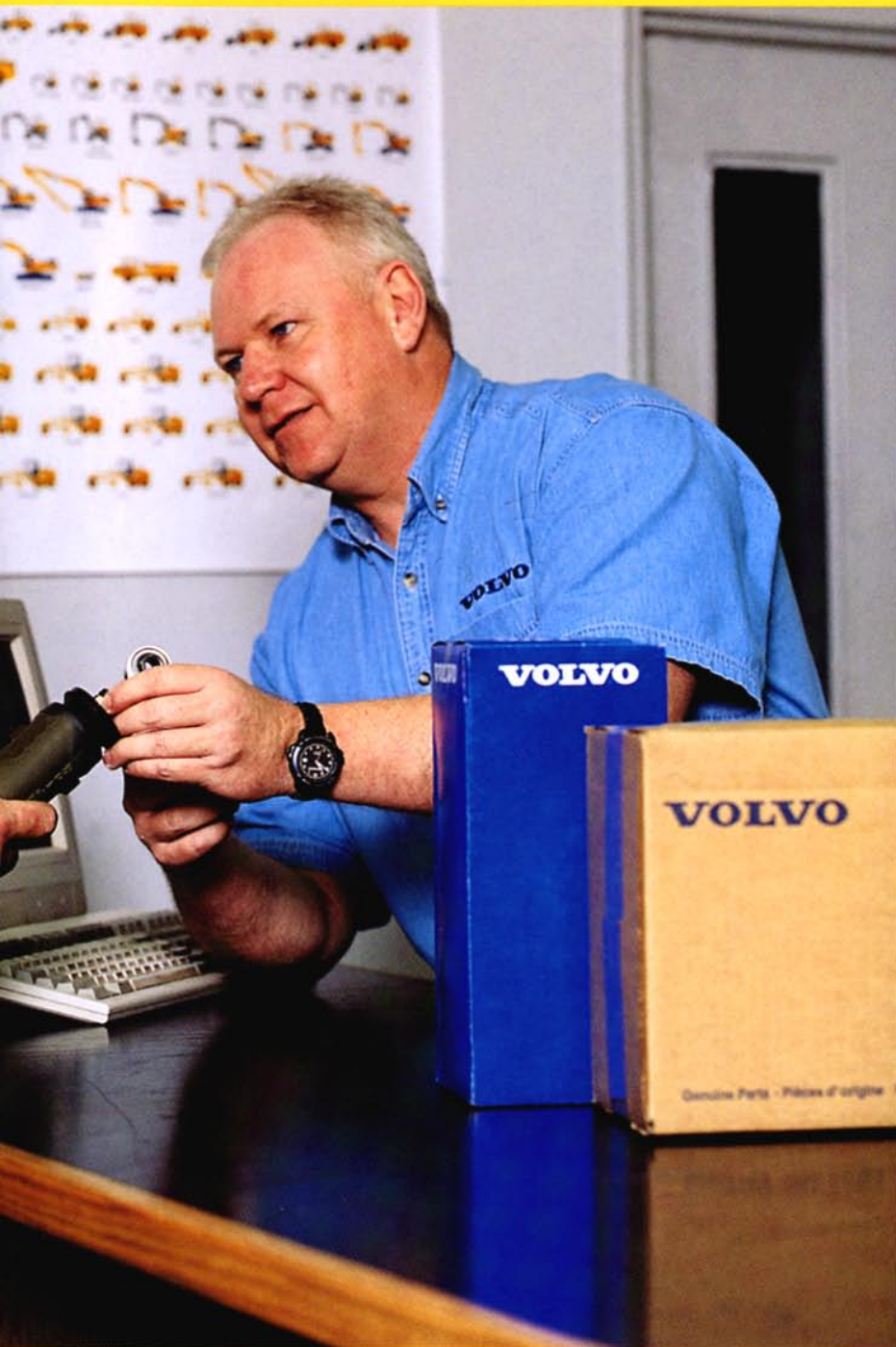

The Volvo Electronic Data Generation and Exchange (E.D.G.E) system offers round the clock electronic parts ordering and up to the minute order status through an on-line link between your dealer and our central parts distribution center.



Trust your on site maintenance to the people who know your grader best. Our service technicians have the parts, the equipment and the know how to get you up and running quickly and keep you running day after day.



Behind every Volvo Grader is a team of trained grader professionals, working to keep your machine performing with maximum productivity.

# GRADER INNOVATION YESTERDAY, TODAY AND TOMORROW

For nearly 125 years, we have been building and maintaining roads around the world and building our reputation as the grader experts in the process.

We've always listened to our customers and looked for new ways to make our graders tougher, more powerful, more comfortable and more productive. We've extended and improved our line of attachments to make our graders more versatile. We've also worked to make our support organization the best in the world.

## Built on Experience

Volvo Graders are a combination of the most advanced design and manufacturing technologies and our many years of grader experience. With innovations in virtually every component, Volvo Graders are an industry leader in reliability and performance.

## Ready for the Future

Volvo is committed to advancing graders and grader technology, to set new benchmarks for power, performance and reliability that allow you to do your job more efficiently and cost effectively than ever before.

For superior graders, attachments and product support, rely on Volvo.



Since 1875, Champion has been a pioneer in grader design.

- The first horse drawn grader
- The first self-propelled grader
- And the first all hydraulic grader
- ... were all Champions.

Today, Volvo Motor Graders continues this rich tradition of innovation.



At our manufacturing centers in Goderich, Ontario, Canada; Charlotte, North Carolina, USA and Pederneiras, Sao Paulo, Brazil, we build, test and ship graders to customers all over the world and coordinate all parts and service support.

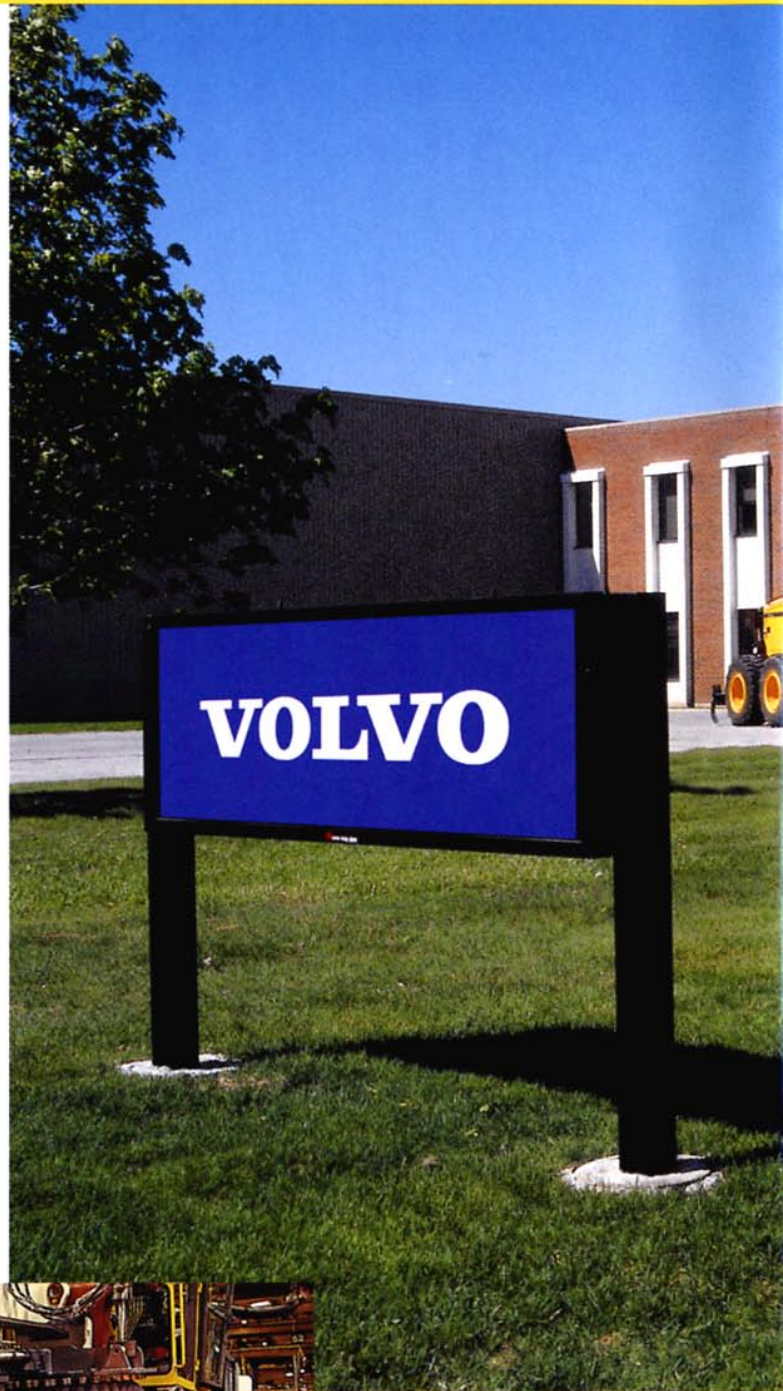



## MOTOR GRADER TRAINING CENTER

Volvo continues to invest in our people and equipment in order to maximize our manufacturing efficiency and produce the highest quality products.

### Grader Milestones



1928



1946



1975



1989



1994



2001



## Technology on Human Terms

Volvo Construction Equipment is one of the world's leading manufacturers of construction machines, with a product range encompassing wheel loaders, excavators, articulated haulers, motor graders and more.

The tasks they face vary considerably, but they all share one vital feature: technology which helps man to perform better: safely, efficiently and with care of the environment. We refer to it as Technology on Human Terms.

The sheer width of the product range means it is always possible to choose exactly the right machine and attachment for the job. Each machine also comes with the quality, continuity and security which is represented by the

Volvo name. The strength of the service and parts organizations; the security of always having immediate access to leading-edge research and technical development are part of the Volvo name. A machine from Volvo meets the very highest demands in all kinds of jobs, under all conditions, the world over.

*Volvo Construction Equipment develops, manufactures and markets Volvo construction equipment. We are a Volvo company with production facilities on four continents and a market presence in over 100 countries.*

For more information please visit our web site: [www.volvo.com](http://www.volvo.com)

*All products are not available in all markets. Under our policy of continuous improvement, we reserve the right to change specifications and designs without prior notice. The illustrations do not necessarily show the standard version of the machine.*

# VOLVO

Volvo Construction Equipment

Ref. No. 21 2 434 1029 English  
Printed in Canada 2001.05-20 GDR  
Volvo, Goderich