

VOLVO EXCAVATOR

EC360B LC EC360B NLC

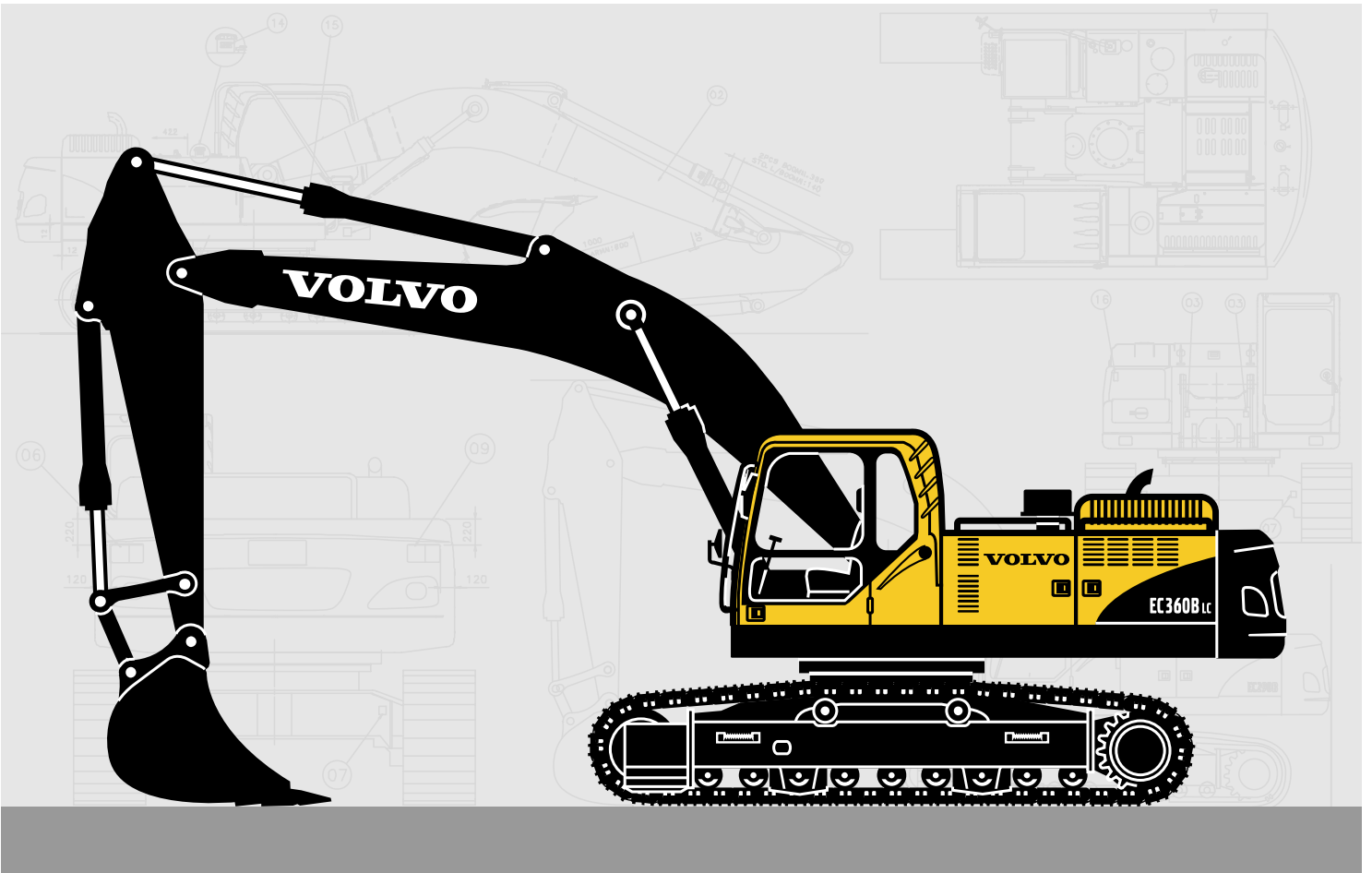

- Engine power, gross:
198 kW (265 hp)
- Operating weight:
LC: 37,1 ~ 38,4 t
NLC: 36,3 ~ 37,5 t
- Buckets (SAE):
1 350 ~ 3 000 l
- Turbocharged VOLVO diesel engine with direct injection and charged air cooler meets EU Step 2 requirements
- Contronics, advanced mode selection system and electronically controlled system
- 2 variable displacement axial piston pumps. Independent and simultaneous movements of the digging equipment are controlled by "Automatic Sensing Work Mode".
- Cab
 - Ergonomic environment
 - Low sound level
 - Filtered air
 - Hydraulic dampening mounts
- Strong digging equipment, produced by robotic welding
- High lifting, breakout and tearout forces for tough digging conditions
- Undercarriage
 - LC: Long undercarriage for good stability
 - NLC: Narrow width for easy transportation
- Auxiliary hydraulic valve as standard
- Prepared for a number of optional items

VOLVO



ENGINE

The engine is a turbocharged, 4-stroke diesel engine with water cooling, direct injection and charged air cooler that meets EU Step 2 requirements.

The engine has been developed especially for excavator use, providing good fuel economy, low noise levels and a long service life.

Air Filter: 3-stage, includes pre-cleaner

Automatic Idling System: Reduces engine speed to idle when the levers and pedals are not activated resulting in less fuel consumption and low cab noise level.

Low-Emission Engine:

Make	VOLVO
Model	D10B EBE2
Power output at	28 r/s (1 700 rpm)
Net (ISO 9249/ DIN 6271)	184 kW (250 ps / 247 hp)
Gross (SAE J1995)	198 kW (269 ps / 265 hp)
Max. torque	1 255 N·m at 1 400 rpm
No. of cylinders	6
Displacement	9,6 l
Bore	120,7 mm
Stroke	140 mm



ELECTRICAL SYSTEM

Well-protected electrical system with high capacity. Waterproof double-lock harness plugs are used to secure corrosion free connections. The main relays and solenoid valves are shielded to prevent damage. A master switch is standard.

Contronics, provides advanced monitoring of machine function and important diagnostic information.

Voltage	24 V
Batteries	2 x 12 V
Battery capacity	200 Ah
Alternator	28 V / 80 A



UNDERCARRIAGE

The undercarriage has a robust X-shaped frame, greased and sealed track chains are standard.

LC

No. of track shoes	2 x 50
Link pitch	215,9 mm
Shoe width, triple grouser	600 / 700 / 800 / 900 mm
Shoe width, double grouser	600 mm
No. of lower rollers	2 x 9
No. of top rollers	2 x 2

NLC

No. of track shoes	2 x 48
Link pitch	215,9 mm
Shoe width, triple grouser	600 / 700 / 800 / 900 mm
Shoe width, double grouser	600 mm
No. of lower rollers	2 x 8
No. of top rollers	2 x 2



DRIVE

Each track is powered by an automatic two-speed shift travel motor. The track brakes are multi-disc, spring-applied and hydraulic released. The travel motor, brake and planetary gears are well protected in the track frame.

Max. tractive effort	256,9 kN
Max. travel speed	3,3 / 4,5 km/h
Gradeability	35° (70%)



SLEW SYSTEM

The superstructure is slewed by the means of an axial piston motor and a planetary reduction gear. Automatic slew holding brake and anti-rebound valve are standard.

Max. slew speed	9,7 rpm
-----------------	---------



SERVICE REFILL CAPACITIES

Fuel tank	620 l
Hydraulic system, total	500 l
Hydraulic tank	220 l
Engine oil	39,5 l
Engine coolant	58,7 l
Slew reduction unit	6,0 l
Travel reduction unit	2 x 5,5 l



HYDRAULIC SYSTEM

The hydraulic system, named "Automatic Sensing Work Mode", is designed for high-productivity, high-digging capacity, high-maneuvering precision and good fuel economy. The summation system, boom, arm and slew priority along with boom and arm regeneration are provides optimum performance.

The following important functions are included in the system:

Summation system: Combining the flow of both hydraulic pumps to ensure quick cycle times and high productivity.

Boom priority: Gives priority to the boom operation for faster raising when loading or deep excavation.

Arm priority: Gives priority to the arm operation for faster cycle times in leveling and for increased bucket filling when digging.

Slew priority: Supplies priority to the slew operation for faster slew simultaneous operations.

Regeneration system: Prevents cavitation and provides flow to other movements during simultaneous operations for maximum productivity.

Power boost: All digging and lifting forces are increased.

Holding valves: Boom and arm holding valves prevent the digging equipment from creeping.

Power Max: All function speeds are increased.

Main pump:

Type 2 x variable displacement axial piston pumps
Maximum flow ... 2 x 280 l/min

Pilot pump:

Type Gear pump
Maximum flow ... 1 x 25,5 l/min

Hydraulic motors:

Travel Variable displacement axial piston motors
Slew Fixed displacement axial piston motor with mechanical brake

Relief valve setting:

Implement 31,4 / 34,3 Mpa
Travel circuit 34,3 Mpa
Slew circuit 25,5 Mpa
Pilot circuit 3,9 Mpa

Hydraulic cylinders:

Boom 2
Bore x Stroke \varnothing 160 x 1 530 mm
Arm 1
Bore x Stroke \varnothing 175 x 1 700 mm
Bucket 1
Bore x Stroke \varnothing 145 x 1 285 mm
ME bucket 1
Bore x Stroke \varnothing 160 x 1 250 mm



CAB

The operator's cab has easy access via a wide door opening. The cab is supported on hydraulic dampening mounts to reduce shock and vibration levels. These along with a sound absorbing lining provide low noise levels. The cab has excellent all-round visibility. The front windshield can easily slide up into the ceiling, and the lower front glass can be removed and stored. The glass is stored in the door.

Integrated air conditioning and heating system:

The pressurized and filtered cab air is supplied by automatically controlled fan. The air is distributed via 13 vents.

Ergonomic operator's seat: The adjustable seat and joystick consoles move independently to accommodate the operator. The seat has nine different adjustments and a seat belt to meet any operator's comfort and safety.

Sound Level:

Sound level in cab
according to ISO 6396 LpA 73 dB(A)
External sound level
according to ISO 6395 LwA105 dB(A)
(Directive 2000/14/EC)



GROUND PRESSURE

- Long crawler machine with 6,45 m boom, 3,2 m arm, 1 610 l (1 460 kg) bucket and 7 250 kg counterweight.

Description	Shoe width	Operating weight	Ground pressure	Overall width
Triple grouser	600 mm	37 050 kg	66,7 kPa	3 340 mm
	700 mm	37 490 kg	57,9 kPa	3 440 mm
	800 mm	37 920 kg	51,0 kPa	3 540 mm
	900 mm	38 360 kg	46,1 kPa	3 640 mm
Double grouser	600 mm	37 160 kg	66,7 kPa	3 340 mm

- Narrow long crawler machine with 6,45 m boom, 3,2 m arm, 1 610 l (1 460 kg) bucket and 7 250 kg counterweight.

Description	Shoe width	Operating weight	Ground pressure	Overall width
Triple grouser	600 mm	36 250 kg	65,7 kPa	2 990 mm
	700 mm	36 680 kg	56,9 kPa	3 090 mm
	800 mm	37 100 kg	50,0 kPa	3 190 mm
	900 mm	37 530 kg	45,1 kPa	3 290 mm
Double grouser	600 mm	36 360 kg	65,7 kPa	2 990 mm

MAX. PERMITTED BUCKETS

*Note: 1. Bucket size based on SAE-J296, heaped material with a 1:1 angle of repose.
2. "Max permitted sizes" are for reference only and are not necessarily available from the factory.*

- Max. permitted sizes for direct fit buckets:
Long crawler machine with counterweight 7 250 kg

Description	Unit	6,2 m ME boom	6,45 m Boom		
		2,6 m Arm	2,6 m Arm	3,2 m Arm	3,9 m Arm
GP bucket 1,5 t/m ³	l	3 000	2 825	2 600	2 375
GP bucket 1,8 t/m ³	l	2 625	2 475	2 275	2 075
RB bucket 1,8 t/m ³	l	2 425	2 300	2 100	1 925
RB bucket 2,0 t/m ³	l	2 250	2 125	1 950	1 775

- Max. permitted sizes for quick fit buckets:
Long crawler machine with counterweight 7 250 kg

Description	Unit	6,2 m ME boom	6,45 m Boom		
		2,6 m Arm	2,6 m Arm	3,2 m Arm	3,9 m Arm
GP bucket 1,5 t/m ³	l	2 850	2 700	2 475	2 250
GP bucket 1,8 t/m ³	l	2 500	2 375	2 175	1 950
RB bucket 1,8 t/m ³	l	2 300	2 175	2 000	1 800
RB bucket 2,0 t/m ³	l	2 150	2 025	1 850	1 675

- Max. permitted sizes for direct fit buckets:
Narrow long crawler machine with counterweight 7 250 kg

Description	Unit	6,2 m ME boom	6,45 m Boom		
		2,6 m Arm	2,6 m Arm	3,2 m Arm	3,9 m Arm
GP bucket 1,5 t/m ³	l	2 450	2 300	2 125	1 925
GP bucket 1,8 t/m ³	l	2 150	2 025	1 850	1 675
RB bucket 1,8 t/m ³	l	1 975	1 850	1 700	1 550
RB bucket 2,0 t/m ³	l	1 825	1 725	1 600	1 450

- Max. permitted sizes for quick fit buckets:
Narrow long crawler machine with counterweight 7 250 kg

Description	Unit	6,2 m ME boom	6,45 m Boom		
		2,6 m Arm	2,6 m Arm	3,2 m Arm	3,9 m Arm
GP bucket 1,5 t/m ³	l	2 325	2 175	1 975	1 800
GP bucket 1,8 t/m ³	l	2 025	1 900	1 725	1 575
RB bucket 1,8 t/m ³	l	1 875	1 750	1 600	1 450
RB bucket 2,0 t/m ³	l	1 725	1 625	1 475	1 350

DIMENSIONS

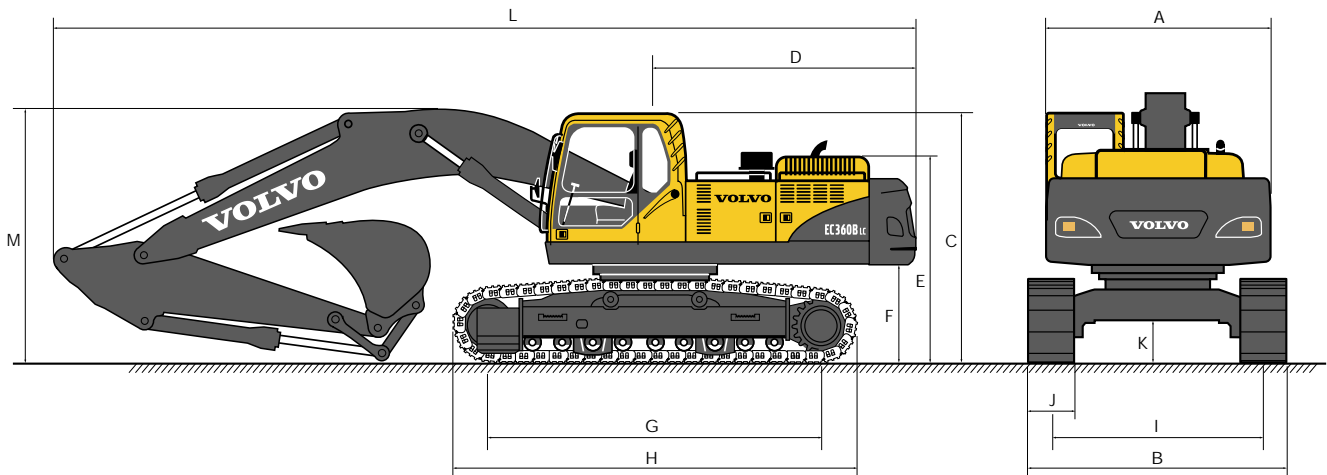

• Long crawler machine

Description	Unit	6,2 m ME boom	6,45 m Boom		
		2,6 m Arm	2,6 m Arm	3,2 m Arm	3,9 m Arm
A. Overall width of superstructure	mm	2 990	2 990	2 990	2 990
B. Overall width	mm	3 340	3 340	3 340	3 340
C. Overall height of cab	mm	3 190	3 190	3 190	3 190
D. Tail slew radius	mm	3 390	3 390	3 390	3 390
E. Overall height of engine hood	mm	2 700	2 700	2 700	2 700
F. Counterweight clearance *	mm	1 210	1 210	1 210	1 210
G. Tumbler length	mm	4 240	4 240	4 240	4 240
H. Track length	mm	5 180	5 180	5 180	5 180
I. Track gauge	mm	2 740	2 740	2 740	2 740
J. Shoe width	mm	600	600	600	600
K. Min. ground clearance *	mm	500	500	500	500
L. Overall length	mm	10 910	11 160	11 070	11 120
M. Overall height of boom	mm	3 700	3 580	3 350	3 590

• Narrow long crawler machine

Description	Unit	6,2 m ME boom	6,45 m Boom		
		2,6 m Arm	2,6 m Arm	3,2 m Arm	3,9 m Arm
A. Overall width of superstructure	mm	2 990	2 990	2 990	2 990
B. Overall width	mm	2 990	2 990	2 990	2 990
C. Overall height of cab	mm	3 190	3 190	3 190	3 190
D. Tail slew radius	mm	3 390	3 390	3 390	3 390
E. Overall height of engine hood	mm	2 700	2 700	2 700	2 700
F. Counterweight clearance *	mm	1 210	1 210	1 210	1 210
G. Tumbler length	mm	4 020	4 020	4 020	4 020
H. Track length	mm	4 962	4 962	4 962	4 962
I. Track gauge	mm	2 390	2 390	2 390	2 390
J. Shoe width	mm	600	600	600	600
K. Min. ground clearance *	mm	500	500	500	500
L. Overall length	mm	10 910	11 160	11 070	11 120
M. Overall height of boom	mm	3 700	3 580	3 350	3 590

* Without shoe grouser

DIMENSIONS

• Boom

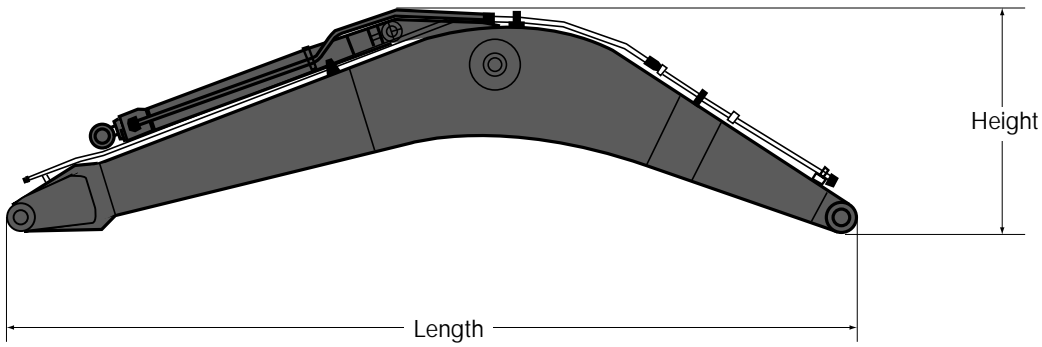

Description	6,2 m ME	6,45 m
Length	6 460 mm	6 700 mm
Height	1 740 mm	1 800 mm
Width	820 mm	820 mm
Weight	3 230 kg	3 210 kg

* Includes cylinder, pin and piping

• Arm

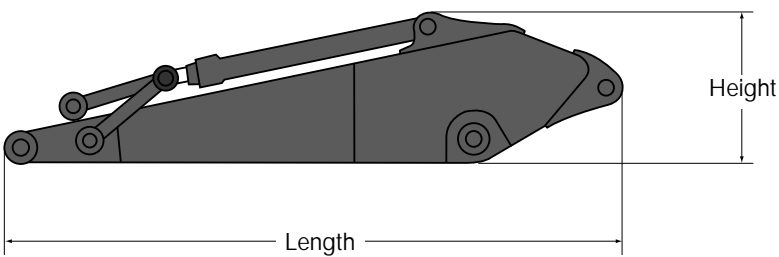

Description	2,6 m	3,2 m	3,9 m
Length	3 780 mm	4 360 mm	5 080 mm
Height	1 145 mm	1 145 mm	1 140 mm
Width	560 mm	560 mm	560 mm
Weight	1 975 kg	2 025 kg	2 165 kg

* Includes cylinder, piping and linkage

WORKING RANGES & DIGGING FORCES

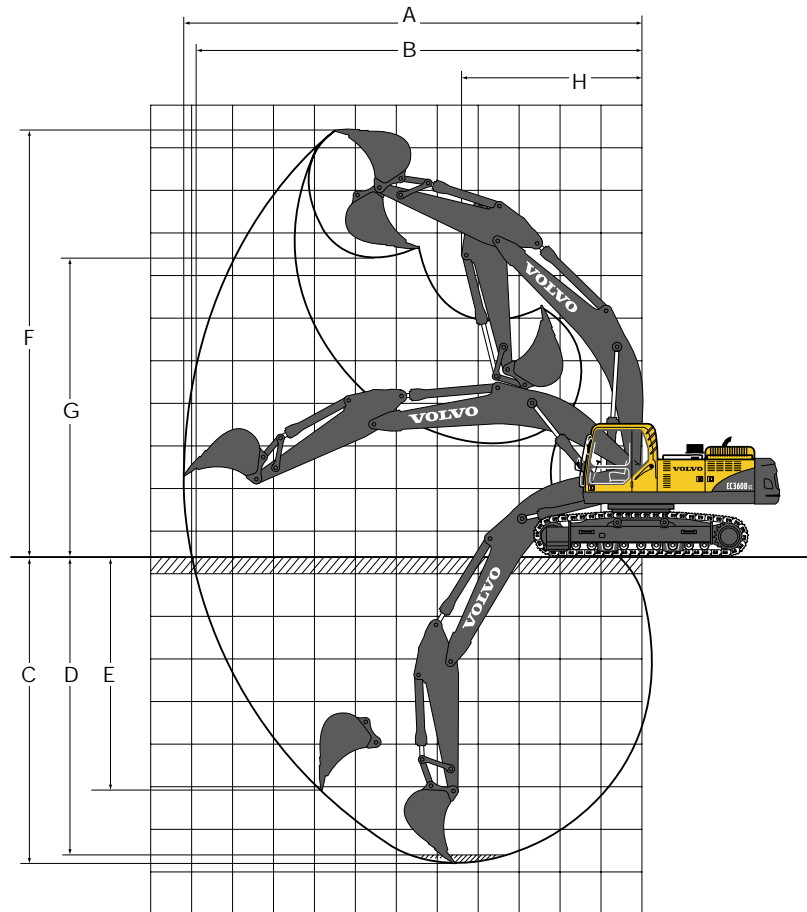

• Machine with direct fit GP bucket

Description	Unit	6,2 m ME boom		6,45 m Boom	
		2,6 m Arm	2,6 m Arm	3,2 m Arm	3,9 m Arm
A. Max. digging reach	mm	10 480	10 660	11 180	11 820
B. Max. digging reach on ground	mm	10 250	10 440	10 970	11 620
C. Max. digging depth	mm	6 720	6 890	7 490	8 200
D. Max. digging depth	mm	6 540	6 690	7 320	8 050
E. Max. vertical wall digging depth	mm	4 800	5 110	5 510	6 140
F. Max. cutting height	mm	10 070	10 160	10 320	10 600
G. Max. dumping height	mm	6 830	7 050	7 240	7 520
H. Min. front slew radius	mm	4 180	4 380	4 340	4 320















• Digging forces with direct fit bucket

Description		Unit	6,2 m ME boom		6,45 m Boom	
			2,6 m Arm	2,6 m Arm	3,2 m Arm	3,9 m Arm
Bucket radius		mm	1 810	1 623	1 623	1 623
Breakout force – bucket (Normal / Power boost)	SAE	kN	208 / 228	192 / 209	192 / 209	192 / 209
Breakout force – bucket (Normal / Power boost)	ISO	kN	236 / 258	215 / 236	215 / 236	215 / 236
Tearout force – arm (Normal / Power boost)	SAE	kN	182 / 200	190 / 207	157 / 172	137 / 150
Tearout force – arm (Normal / Power boost)	ISO	kN	188 / 206	195 / 213	161 / 176	140 / 153
Rotation angle, bucket		deg	164	177	177	177

LIFTING CAPACITY (At the arm and without bucket)

Note: For lifting capacity including bucket, simply subtract actual weight of the direct fit bucket or the bucket with quick fit from the following values.

EC360BLC















 Across undercarriage  Along undercarriage	Lifting hook related to ground level	3,0 m		4,5 m		6,0 m		7,5 m		9,0 m		Max. reach			
														Max. mm	
with 600 mm shoe 7 250 kg CWT ME boom 6,2 m + arm 2,6 m	6,0 m	kg				*10 970	*10 970	*10 470	7 870			*9 900	7 450	7 730	
	4,5 m	kg			*15 660	*15 660	*12 440	10 870	*10 960	7 700		*9 950	6 500	8 330	
	3,0 m	kg			*19 660	15 760	*14 260	10 340	11 650	7 460		9 350	6 030	8 620	
	1,5 m	kg			*20 950	14 990	*15 790	9 910	11 390	7 230		9 190	5 900	8 640	
	0 m	kg			*22 650	14 750	15 840	9 670	11 230	7 080		9 520	6 070	8 390	
	-1,5 m	kg	*16 060	*16 060	*21 800	14 770	15 770	9 610	11 210	7 070		10 500	6 660	7 850	
	-3,0 m	kg	*26 270	*26 270	*19 650	14 980	*14 880	9 730				*12 240	8 000	6 930	
	-4,5 m	kg			*15 180	*15 180						*12 000	11 560	5 470	
with 600 mm shoe 7 250 kg CWT boom 6,45 m + arm 2,6 m	6,0 m	kg						*9 310	8 070			*6 940	6 410	7 980	
	4,5 m	kg			*14 150	*14 150	*11 420	11 030	*10 070	7 830	*8 140	5 840	*7 010	5 700	8 560
	3,0 m	kg			*18 270	15 890	*13 380	10 420	*11 100	7 520	8 830	5 710	*7 290	5 330	8 840
	1,5 m	kg			*21 270	14 910	*15 120	9 900	11 400	7 240	8 670	5 570	*7 830	5 210	8 860
	0 m	kg			*21 770	14 520	15 740	9 570	11 180	7 030	8 570	5 470	8 320	5 320	8 620
	-1,5 m	kg	*13 840	*13 840	*22 100	14 460	15 590	9 440	11 080	6 940			8 980	5 720	8 090
	-3,0 m	kg	*21 920	*21 920	*20 690	14 600	15 650	9 500	11 150	7 010			10 400	5 800	7 210
	-4,5 m	kg	*24 000	*24 000	*17 740	14 970	*13 340	9 760					*11 570	8 540	5 820
with 600 mm shoe 7 250 kg CWT boom 6,45 m + arm 3,2 m	6,0 m	kg						*9 210	7 980			*6 780	6 330	8 590	
	4,5 m	kg			*14 080	*14 080	*11 340	10 950	*9 990	7 750	*7 980	5 760	*6 840	5 620	9 120
	3,0 m	kg			*18 250	15 870	*13 320	10 360	*11 020	7 450	8 750	5 630	*7 130	5 250	9 390
	1,5 m	kg			*21 270	14 930	*15 070	9 860	11 340	7 170	8 600	5 490	*7 660	5 130	9 410
	0 m	kg			*21 620	14 540	15 710	9 540	11 120	6 970	8 490	5 400	8 240	5 250	9 180
	-1,5 m	kg	*13 680	*13 680	*22 100	14 480	15 560	9 410	11 020	6 890			8 910	5 640	8 690
	-3,0 m	kg	*21 760	*21 760	*20 680	14 620	15 620	9 460	11 080	6 940			10 330	6 510	7 880
	-4,5 m	kg	*24 040	*24 040	*17 720	14 960	*13 290	9 710					*11 500	8 470	6 630
with 600 mm shoe 7 250 kg CWT boom 6,45 m + arm 3,9 m	6,0 m	kg						*9 110	7 900			*6 700	6 240	9 290	
	4,5 m	kg			*13 960	*13 960	*11 220	10 860	*9 880	7 650	*7 900	5 670	*6 760	5 530	9 790
	3,0 m	kg			*18 810	15 740	*13 190	10 260	*10 900	7 350	8 660	5 540	*7 040	5 160	10 040
	1,5 m	kg			*21 120	14 790	*14 940	9 740	11 240	7 070	8 500	5 400	*7 580	5 040	10 060
	0 m	kg			*21 560	14 400	15 590	9 420	11 010	6 870	8 400	5 300	8 150	5 150	9 840
	-1,5 m	kg	*13 610	*13 600	*21 950	14 340	15 440	9 300	10 910	6 780			8 810	5 550	9 390
	-3,0 m	kg	*21 690	*21 690	*20 540	14 480	*15 490	9 340	10 980	6 840			10 230	6 410	8 640
	-4,5 m	kg	*23 870	*23 870	*17 580	14 830	*13 160	9 600					*11 380	8 370	7 530

- Notes:
- Machine in "Fine Mode-F" (Power Boost), for lifting capacities.
 - The above loads are in compliance with SAE and ISO Hydraulic Excavator Lifting Capacity Standards.
 - Rated loads do not exceed 87% of hydraulic lifting capacity or 75% of tipping load.
 - Rated loads marked with an asterisk (*) are limited by hydraulic capacity rather than tipping load.

LIFTING CAPACITY (At the arm and without bucket)

Note: For lifting capacity including bucket, simply subtract actual weight of the direct fit bucket or the bucket with quick fit from the following values.

EC360B NLC

 Across undercarriage  Along undercarriage	Lifting hook related to ground level	3,0 m		4,5 m		6,0 m		7,5 m		9,0 m		Max. reach		Max. mm
														
with 600 mm shoe 7 250 kg CWT boom 6,45 m + arm 2,6 m	6,0 m kg					*10 680	9 320	*10 010	6 480			*8 550	5 800	7 980
	4,5 m kg			*15 810	13 620	*12 260	8 850	10 460	6 280			8 410	5 050	8 560
	3,0 m kg			*19 920	12 420	*14 130	8 330	10 170	6 030			7 850	4 670	8 840
	1,5 m kg			*15 540	11 760	13 950	7 910	9 910	5 800			7 710	4 540	8 860
	0 m kg			*20 110	11 590	13 680	7 690	9 740	5 650			7 950	4 660	8 620
	-1,5 m kg	*14 250	*14 250	*21 580	11 630	13 620	7 630	9 710	5 620			8 710	5 090	8 090
	-3,0 m kg	*25 530	23 610	*19 630	11 830	13 750	7 740					10 430	6 050	7 210
	-4,5 m kg	*20 640	*20 640	*15 800	12 230							*11 870	8 450	5 820
with 600 mm shoe 7 250 kg CWT boom 6,45 m + arm 3,2 m	6,0 m kg							*9 210	6 740			*7 330	5 310	8 590
	4,5 m kg			*14 080	*14 080	*11 340	9 200	*9 990	6 510	8 020	4 810	*7 400	4 690	9 120
	3,0 m kg			*18 250	13 020	*13 320	8 630	10 490	6 220	7 880	4 690	7 350	4 360	9 390
	1,5 m kg			*21 270	12 130	14 360	8 150	10 180	5 950	7 730	4 550	7 220	4 250	9 410
	0 m kg			*21 620	11 770	14 000	7 840	9 970	5 760	7 630	4 460	7 410	4 330	9 180
	-1,5 m kg	*13 680	*13 680	*22 100	11 710	13 860	7 720	9 870	5 680			8 000	4 660	8 690
	-3,0 m kg	*21 760	*21 760	*20 680	11 840	13 910	7 760	9 940	5 730			9 270	5 380	7 880
	-4,5 m kg	*24 040	*24 040	*17 720	12 160	*13 290	8 010					*11 500	7 010	6 630
with 600 mm shoe 7 250 kg CWT boom 6,45 m + arm 3,9 m	6,0 m kg							*8 320	6 860	*6 960	4 980	*5 490	4 680	9 290
	4,5 m kg					*10 170	9 360	*9 180	6 590	8 020	4 870	*5 530	4 180	9 790
	3,0 m kg			*16 190	13 290	*12 230	8 720	*10 300	6 250	7 830	4 700	*5 730	3 900	10 040
	1,5 m kg			*19 780	12 120	*14 200	8 120	10 070	5 920	7 630	4 510	*6 100	3 790	10 060
	0 m kg	*8 370	*8 370	*21 720	11 500	13 720	7 700	9 770	5 660	7 470	4 370	6 550	3 840	9 840
	-1,5 m kg	*12 980	*12 980	21 950	11 280	13 470	7 490	9 610	5 510	7 400	4 300	6 970	4 070	9 390
	-3,0 m kg	*18 860	*18 860	*21 390	11 320	13 440	7 460	9 590	5 500			7 870	4 580	8 640
	-4,5 m kg	*27 080	22 860	*19 270	11 580	13 620	7 620	9 790	5 680			9 740	5 650	7 530

- Notes:
- Machine in "Fine Mode-F" (Power Boost), for lifting capacities.
 - The above loads are in compliance with SAE and ISO Hydraulic Excavator Lifting Capacity Standards.
 - Rated loads do not exceed 87% of hydraulic lifting capacity or 75% of tipping load.
 - Rated loads marked with an asterisk (*) are limited by hydraulic capacity rather than tipping load.

STANDARD EQUIPMENT

Engine

Turbocharged, 4 stroke diesel engine with water cooling, direct injection and charged air cooler that meets EU Step 2 requirements
3-stage air filter with indicator, including pre-cleaner
Air intake heater
Electric engine shut-off
Fuel filter and water separator
Fuel filler pump: 50 l/min with automatic shut-off
Coolant filter
Alternator, 80 A

Electric / Electronic control system

Contronics:
– Advanced mode control system
– Self-diagnostic system
Machine status indication
Engine speed sensing power control
"Power Max" mode system
Automatic idling system

One-touch power boost
Safety stop/start function
Adjustable monitor
Master switch
Engine restart prevention circuit
High capacity halogen lights:
– Frame mounted 2
– Boom mounted 4
Batteries, 2 x 12 V / 200 Ah
Start motor, 24 V / 6,6 kW

Hydraulic system

Automatic hydraulic system:
– Summation system
– Boom priority
– Arm priority
– Slew priority
Boom and arm regeneration valves
Slew anti-rebound valves
Boom and arm holding valves
Multi-stage filtering system
Cylinder cushioning
Cylinder contamination seals
Hose rupture valve: boom
Auxiliary hydraulic valve

Straight travel circuit
Automatic two-speed travel motors
Hydraulic oil, ISO VG 46

Superstructure

Access way with handrail
Tool storage area
Punched metal anti-slip plates
Undercover (heavy duty 4,5 mm)
Counterweight, 7 250 kg

Cab and interior

Heater & air-conditioner, automatic
Hydraulic dampening cab mounts
Adjustable operator seat and joystick control console
Flexible antenna
Hydraulic safety lock lever
Control joystick, with 5 switches each
Cab, all-weather sound suppressed, includes:
– Ashtray
– Cup holder
– Lighter
– Door locks

– Tinted glass
– Floor mat
– Horn
– Large storage area
– Pull-up type front window
– Removable lower windshield
– Seat belt
– Safety glass
– Windshield wiper with intermittent feature
– Stereo cassette radio
Anti-vandalism kit assembly preparation
Sun shield, front, roof, rear
Master ignition key

Undercarriage

Hydraulic track adjusters
Greased and sealed track chain
Track guards
Undercover (heavy duty 10 mm)

Service

Tool kit, daily maintenance

ALTERNATIVE EQUIPMENT

Cab and interior

Seat:
– Fabric seat
– Fabric seat, with heater
– Fabric seat, with heater and air suspension

Track shoes

600/700/800/900 mm track shoes with triple grousers
600 mm track shoe with double grouser

Digging equipment

Boom: 6,2 m monoblock, ME
6,45 m monoblock
Arm: 2,6/3,9 m
3,2 m

Undercarriage

LC (Long crawler)
NLC (Narrow long crawler)

OPTIONAL EQUIPMENT (Standard in certain markets)

Engine

Block heater, 240 V
Oil bath pre-cleaner
Diesel coolant heater
Tropical cooling kit

Electric

Extra lamps:
– Cab-mounted 3, (front 2, rear 1)
– Counterweight-mounted 1
Overload warning device
Rotating warning beacon
Travel alarm

Hydraulic system

Hose rupture valve: dipper arm
Hydraulic piping
– Hammer & shears:
1 pump or 2 pump flow
Pump flow control for hammer & shears
Additional return filter
Extra piping for slope & rotator
– Slope & rotator
– Grapple
– Oil leak (drain) line
– Quick fit piping
Volvo hydraulic quick-fit, S3 size
Hydraulic oil, ISO VG 32
Hydraulic oil, ISO VG 68

Hydraulic oil, biodegradable 32
Hydraulic oil, biodegradable 46
Boom floating function

Superstructure

Service walk
Cab entrance step
Hydraulically removable counterweight

Cab and interior

Falling object guard (FOG)
Cab mounted falling object protective structures (FOPS)
Rain shield, front
Sunlight protection, roof (steel)
Safety net for front window
Lower wiper
Anti-vandalism kit
Specific key

Undercarriage

Full track guards

Service

Tool kit, full scale

All products are not available in all markets. Under our policy of continuous improvement, we reserve the right to change specifications and designs without prior notice. The illustrations do not necessarily show the standard version of the machine.

VOLVO

Construction Equipment

Ref. No. 21 C 435 1645
Printed in Korea 2003.04-1
Volvo, Seoul

English, global
KOR