

VOLVO WHEEL LOADER

L180F HIGH-LIFT



MORE CARE. BUILT IN.



A COMPLETE LOG HANDLER FROM THE GROUND UP

Volvo L180F High-Lift is much more than a wheel loader equipped with a high-lift unit. The entire machine is designed and built by Volvo. We have built a complete and genuine high-lift machine from the ground up, tailor-made and purpose-designed. Volvo L180F High-Lift is easy to operate, smooth, quiet, fast and powerful.

Reach a new level of efficiency

With an 8.6 ton working load, 19 feet lift height under closed grapple, a grapple capacity of 34.4 ft² and 13'1" reach, Volvo L180F High-Lift is the most powerful, efficient, and productive high-lift we've ever built for log handling. High lift height, long reach, and articulated steering give short cycle times in applications such as unloading logs and pulp wood stacking, as well as unloading sorting hoppers and feed tables. Cycle time can also be reduced by the machine's standard high-lift attachment which enables 360 degree rotation, making it possible to reach the logs with any grapple from all sides of the stack.

Higher stacks give 60 percent smaller storage area

The ability to build higher stacks makes it possible to significantly cut the size of storage areas. In fact, by using the maximal lift height when stacking logs you can utilize the stockyard's surface 60–70 percent more effectively than in traditional log handling.

We set our goals a little higher

Before a new machine generation is launched on the market, every vital component and newly designed system has been individually tested for durability and fatigue properties in test rigs. Only after passing that stage are they ready to meet the world's toughest test environment – the customers' reality – for thousands of hours in our prototypes and pre-series machines. Feedback about every detail is reported to our engineers.

Specification	L180F High-Lift
Engine:	Volvo D12D LA E3
Max power at:	23,3-26,7 r/s (1400–1600 rpm)
SAE J1995, gross:	235 kW (315 hp)
SAE J1349/ISO 9249, net:	234 kW (314 hp)
Max torque at:	23,3 r/s (1400 rpm)
SAE J1995 gross:	1603 Nm (1.182 lbf ft)
ISO 9249, SAE J1349:	1594 Nm (1.176 lbf ft)
Operating weight:	36 600 kg* (80.690 lb)*
Grapples:	3,2–3,8 m ² (34.4–40.9 ft ²)
Tires:	775/65 R29**

* with 3,2 m² (34.4 ft²) grapple, all four tires liquid-filled, log pusher, full cover mudguards, protection bar at the front and grill guard

** liquid in rear tires





TAKING COMFORT AND PRODUCTIVITY TO AN ALL-TIME HIGH

Volvo has designed wheel loaders since 1954. Right from the beginning we put safety first, but not at the expense of comfort, operating joy, and power. Quite the opposite. We know that safety, as well as productivity, is partly the result of a satisfied operator – man and machine in perfect harmony.

Load-sensing hydraulics for exact force with less fuel

Volvo's in-house manufactured drivetrain, hydraulics, and linkage with improved lift height and visibility are tailored to work together in perfect harmony. The L180F High-Lift is powered by Volvo's fuel-efficient 12 liter V-ACT engine, designed specifically for high horsepower and torque at low rpm. Volvo's load-sensing hydraulic system contributes to the low fuel consumption by always delivering the right power to several hydraulic functions simultaneously, without unnecessary pumping of the oil. You can close the grapple with full force and lift the grapple arm at the same time, which increases productivity throughout the whole work process.

Well protected in an even more effective workplace

The new generation's Volvo Care Cab is quieter, cleaner, and roomier. Visibility has been improved and the cab is safer, both inside and outside. Comfort has been improved with Automatic Heat Control, better vibration-damping and the best filtration on the market. The result is the best Care Cab we've ever built. Simply put – the industry's most effective workplace.

Smooth automatic shifting and lever steering

Volvo Automatic Power Shift (APS), with mode selector, contributes to fast and effective work cycles. The automatic shifting adapts to the operating conditions and saves fuel by always selecting the right gear. With lever steering Comfort Drive Control (CDC)*, the operator can easily switch between using the steering wheel and lever steering, reducing harmful static muscle strain.

Only genuine Volvo grapples make the perfect match

Every genuine Volvo grapple is designed as an integrated part of the wheel loader. Their functions and properties are precisely matched to the machine's parameters. This is actually an absolute precondition for our machines to deliver what we promise – the highest possible productivity.

* Optional equipment





BUILT TO RUN – SUPPORTED FOR LIFE

When you invest in a Volvo High-Lift, you get a machine of the very highest quality. But of course, even the best machines need service and maintenance to be as productive tomorrow as they are today. Customer Support will help you to keep an eye on your owning and operating costs.

We care about your operation - anywhere at anytime

Volvo Construction Equipment centers around a professional Customer Support organization, providing parts supply, aftersales services, and training. All this gives customer benefits through controlled owning and operating costs. When you invest in a Volvo wheel loader, the availability of good service and access to genuine Volvo parts are just as important as the price. After all, it is the total cost during the machine's entire life that's interesting. With all the products and resources we have at our disposal, we can offer you the best support. Anywhere, anytime.

Four levels of support, one level of care

The best way to get the most out of your Volvo wheel loader is to invest in a Volvo Customer Support Agreement. There are four levels of agreements designed to give you total peace of mind; white, blue, silver, and – of course – gold, which includes all service, maintenance and repairs during the whole contract period at a fixed price. From this completely flexible starting point, we can create an agreement uniquely tailored to the needs of your business and the age of your loaders.

Genuine Volvo parts leave nothing to chance

Each genuine Volvo part is developed for and manufactured together with all other machine components. It's a complete system where each part works in perfect harmony with other parts. Only by using genuine parts can you be sure that your machine retains the qualities and features we gave it from the beginning.



COME CLOSER TO PERFECTION

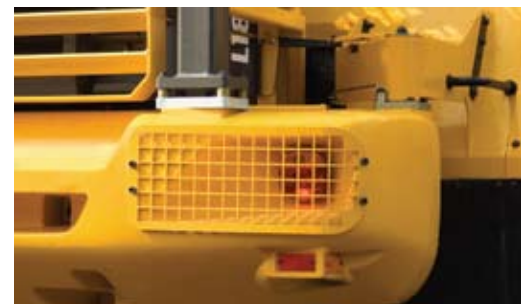

Selection of Volvo optional equipment

Fenders with protection bar

Front and swing-out rear fenders include a protection bar. The bar prevents logs from hitting the front fenders and lights. Rubber extensions help to keep the machine clean.

Comfort Drive Control (CDC)

Lever steering CDC enables the operator to handle steering, shifting forward-reverse, and kick-down with controls in the left armrest. At any time, the operator can change between steering with steering wheel and CDC to avoid static muscle loads.

Extra lighting

Extra lighting on the lift arms increases safety and the number of shifts you can operate. The lights follow the grapple's movements, which increases handling and work capacity in low-light conditions.

Log pusher

Collects logs in front of the machine, increasing maneuverability, safety, and productivity.

Rearview camera system

Rearview camera system reduces blind spots and increases site safety when reversing and also improves operator comfort.

Headlight and tail light guards

Protect the tail lights, headlights, and turn signals from debris that may break or damage the lenses.

Radiator grill guard

Intended to protect the grill, cooling fan, and radiator. It is hinged to facilitate easy cleaning and maintenance.

A MACHINE YOU CAN ALWAYS TRUST

Volvo High-Lift Arm System

- A new Volvo design of tilt and lift arms for improved lift height, reach, and visibility
- Provides superior force throughout the work cycle
- Optimized log grapple visibility for safe and productive operation
- Grapple can be rotated 360 degrees fully open at the top position
- Dual pin seals prevent contamination of pins
- Lift cylinder protection
- End-damping at max. lift and tilt

World-Class, Volvo Care Cab

- Larger and more spacious cab
- Care Cab features the market's best cab filtration system
- Front pillar-mounted switches
- Fully adjustable operator's seat, armrest by hydraulic control levers, steering column, and optional Comfort Drive Control (CDC)*
- Improved all-round visibility includes wide laminated front windshield and floor-to-ceiling glass
- Viscous damping helps to eliminate unwanted noise and vibrations

Volvo Load-Sensing Hydraulics

- Load-sensing hydraulic system provides exact flow and pressure – when and where it's needed

Access and Serviceability

- Easily accessed hatches and service points
- Centralized and grouped pressure check connections
- Lubricated-for-life rear axle bearings
- Slip protected service platforms and handrails, wide and angled cab ladders provide safety
- Long service intervals allow more time for productive work

Commitment to Volvo's Core Values: Quality, Safety, and Care for the Environment

- Roll-Over Protection System (ROPS) provides safe operation
- Non-return valves prevent leakage of both hydraulic and fuel tanks in case of roll-over
- High-quality breather filters on all major components
- Optional biodegradable hydraulic oil allows environment-friendly operation
- All Volvo wheel loaders are more than 95% recyclable
- All electrical wiring is routed through high-quality conduits with sealed connectors



Volvo Contronic Monitoring System

- Network monitors operation and performance in real-time
- The Contronic system warns the operator in time, making it easier for the service technician to troubleshoot, and helps the machine owner tailor the wheel loader to the application
- Fast and easy electronic level checks of oils and fluids
- Display shows continuous operating data, warning texts, and error messages
- Monitors fuel consumption, cycle times, and service intervals
- Available in 24 languages

Volvo Designed and Manufactured Engine

- Turbocharged and Tier 3/Stage IIIA-approved Volvo V-ACT D12D provides tremendous power and impressive low-end torque
- Combines outstanding fuel economy, high reliability, and durability with low levels of noise and exhaust emissions
- Engine control with overspeed protection for optimal performance in all operating conditions
- Hydrostatically-driven, electronically-controlled fan works only when needed, which saves fuel



Volvo HTE Heavy-Duty Transmission

- Automatic Power Shift (APS) with mode selector
- The transmission automatically downshifts to first gear when needed
- Smooth gearshifts and high comfort with Pulse Width Modulation (PWM) gear selector valve

Volvo AWB Heavy-Duty Axles

- Dual-circuit service brakes and automatic parking brake application
- Outboard-mounted wet disc brakes and planetary hub reductions
- Axle oil cooler and filter for front and rear axle
- Differential lock with 100% locking on the front axle
- Simple checking of brake discs with brake wear indicator on all wheels

Volvo Frames

- High-quality steel provides stress resistance and operational stability
- Low vibrations and incredibly low sound levels
- Well organized articulation joint provides very easy access for inspection and maintenance
- Upper and lower joints designed for the highest stress ensure long life and reliability

* Optional equipment

VOLVO L180F HIGH-LIFT IN DETAIL

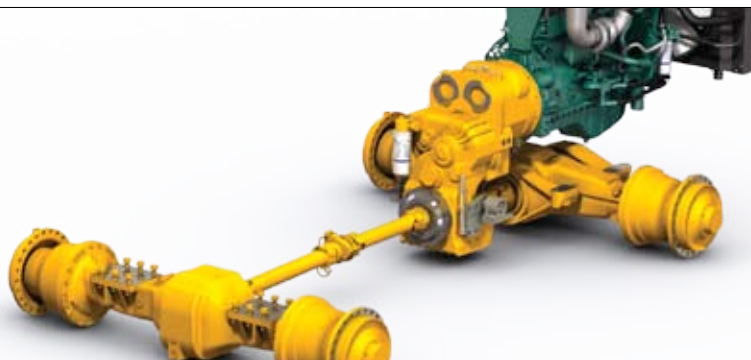

Engine

Engine: V-ACT Stage III A/Tier 3, 12 litre, 6-cylinder in-line turbocharged, air-to-air intercooler diesel engine with double rockers and Internal Exhaust Gas Recirculation (I-EGR). One-piece cylinder head with four valves per cylinder and one overhead camshaft. The engine has wet replaceable cylinder liners and replaceable valve guides and valve seats. Mechanically actuated, electronically-controlled unit injectors. The throttle application is transmitted electrically from the throttle pedal. **Air cleaning:** Three-stage cyclone pre-cleaner – primary filter – secondary filter. **Cooling system:** Hydrostatic, electronically-controlled fan and intercooler of the air-to-air type.

Engine	Volvo D12D LA E3
Max power at	23,3–26,7 r/s (1400–1600 rpm)
SAE J1995 gross	235 kW (315 hp)
ISO 9249, SAE J1349 net	234 kW (314 hp)
Max torque at	23,3 r/s (1400 rpm)
SAE J1995 gross	1603 Nm (1,182 lbf ft)
ISO 9249, SAE J1349 net	1594 Nm (1,176 lbf ft)
Economic working range	800–1600 rpm
Displacement	12,13 l (740 in ³)

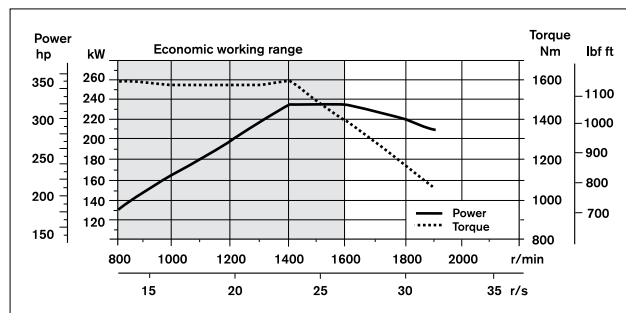

Brake system

Service brake: Volvo dual-circuit system with nitrogen-charged accumulators. Outboard-mounted, hydraulically operated, fully sealed oil circulation-cooled wet disc brakes. The operator can select automatic disengagement of the transmission when braking using Contronic. **Parking brake:** Fully sealed, wet multi-disc brake built into the transmission. Applied by spring force and electro-hydraulically released with a switch on the instrument panel. **Secondary brake:** Dual brake circuits with rechargeable accumulators. Either one circuit or the parking brake fulfills all safety requirements. **Standard:** The brake system complies with the requirements of ISO 3450.

Number of brake discs per wheel front/rear	1/1
Accumulators	2x1.0 l and 1x0.5 l (2x0.26, 1x0.13 US gal)
Accumulators for parking brake	1x0.5 l (1x0.13 US gal)

Drivetrain

Torque converter: single-stage. **Transmission:** Volvo countershaft transmission with single lever control. Fast and smooth shifting of gears with Pulse Width Modulation (PWM) valve. **Gearshifting system:** Volvo Automatic Power Shift (APS) with fully automatic shifting 1-4 and mode selector with 4 different gearshifting programs, including AUTO mode. **Axles:** Volvo fully floating axle shafts with planetary hub reductions and cast steel axle housing. Fixed front axle and oscillating rear axle. 100% differential lock on the front axle.

Transmission	Volvo HTE 220
Torque multiplication	2.1:1
Maximum speed, forward/reverse	
1st gear	6,5 km/h (4.0 mph)
2nd gear	12,5 km/h (7.8 mph)
3rd gear	25,1 km/h (15.6 mph)
4th gear (limited by ECU)*	36,1 km/h (22.4 mph)
Measured with tires	26.5 R25 L3
Front axle/rear axle	Volvo/AWB 40B/40B
Rear axle oscillation	±15°
Ground clearance at 15° osc.	610 mm (24.0 in)

* local restrictions may apply

Electrical system

Central warning system: Contronic electrical system with central warning light and buzzer for following functions: - Serious engine malfunction - Low steering system pressure - Overspeed warning engine - Interruption in communication (computer failure) Central warning light and buzzer with the gear engaged for the following functions. - Low engine oil pressure - High engine oil temperature - High charge-air temperature - Low coolant level - High coolant temperature - High crankcase pressure - Low transmission oil pressure - High transmission oil temperature - Low brake pressure - Engaged parking brake - Brake charging failure - Low hydraulic oil level - High hydraulic oil temperature - Overspeeding in engaged gear - High brake cooling oil temperature front and rear axles.

Voltage	24 V
Batteries	2x12 V
Battery capacity	2x140 Ah
Cold cranking capacity, approx.	1050 A
Reserve capacity	285 min
Alternator rating	2280 W/80 A
Starter motor output	7.0 kW (9.4 hp)



Cab

Instrumentation: All important information is centrally located in the operator's field of vision. Display for Contronic monitoring system. **Heater and defroster:** Heater coil with filtered fresh air and fan with auto and 11 speeds. Defroster vents for all window areas. **Operator's seat:** Operator's seat with adjustable suspension and retractable seatbelt. The seat is mounted on a bracket on the rear cab wall and floor. The forces from the retractable seatbelt are absorbed by the seat rails. **Standard:** The cab is tested and approved according to ROPS (ISO 3471, SAE J1040), FOPS (ISO 3449). The cab meets with requirements according to ISO 6055 (Operator overhead protection - Industrial trucks) and SAE J386 ("Operator Restraint System").

Emergency exits	Use emergency hammer to break window
Sound level in cab according to ISO 6396	LpA 70 dB (A)
External sound level according to ISO 6395	LwA 108 dB (A)
Ventilation	9 m ³ /min (318 ft ³ /min)
Heating capacity	15 kW (51,180 Btu/h)
Air-conditioning (optional)	8 kW (27,300 Btu/h)

Lift-arm system

The Volvo high-lift arm system is a rugged and stable in-house design, with optimized visibility throughout the work cycle. The new lift-arm design gives increased lift height and the possibility to rotate the grapple 360 degrees fully open at top position. The lift height is 5.8 meters (19 feet) under closed grapple.

Lift cylinders	2
Cylinder bore	140 mm (5.5 in)
Piston rod diameter	110 mm (4.3 in)
Stroke	2220 mm (87.4 in)
Tilt cylinder	2
Cylinder bore	140 mm (5.5 in)
Piston rod diameter	70 mm (2.8 in)
Stroke	691 mm (27.2 in)

Steering system

Steering system: Load-sensing hydrostatic articulated steering. **System supply:** The steering system has priority feed from a load-sensing axial piston pump with variable displacement. **Steering cylinders:** Two double-acting cylinders.

Steering cylinders	2
Cylinder bore	100 mm (3.94 in)
Rod diameter	50 mm (1.97 in)
Stroke	418 mm (16.46 in)
Working pressure	21 MPa (3,046 psi)
Maximum flow	190 l/min (50.20 US gpm)
Maximum articulation	±37°

Hydraulic system

Working hydraulic system: Closed center system (load-sensing) with electro-hydraulic pilot-operated valves. **Pumps:** Two variable axial piston pumps. Pump 1 for working hydraulic system. Pump 2 for steering, brake, pilot and working hydraulic system. **Pilot operation:** An electro-hydraulic servo control actuates the 2 control valves via a servo unit. **Valves:** Main valve 1 is a 2 spool control valve for lift and tilt function. Main valve 2 is a 4 spool control valve for grapple, grapple tilt, rotator, and log pusher (optional equipment). **Filter:** Full-flow filtration through 20 micron (absolute) filter cartridge.

Working pressure maximum, pump 1	20.0 MPa (2,901 psi)
Flow at engine speed	247 l/min (65 US gpm) 10 MPa (1,450 psi) 32 r/s (1900 rpm)
Working pressure maximum, pump 2	21.0 MPa (3,046 psi)
Flow at engine speed	247 l/min (65 US gpm) 10 MPa (1,450 psi) 32 r/s (1900 rpm)
Pilot system, working pressure	3.5 MPa (508 psi)
Cycle times	
Lift	8.0 s
Lower	6.5 s
Tilt arm forward	5.4 s
Tilt arm backward	4.3 s
Grapple opening	3.3 s
Grapple closing	3.4 s
Grapple tilt-back	3.3 s
Grapple tilt forward	2.0 s
Rotator	6.3 s/r
Log pusher up	2.0 s
Log pusher down	1.8 s

* with load acc. to ISO 14397 and SAE J818

Service

Service accessibility: Large, easy-to-open service doors with gas struts. Swing-out radiator grill. Fluid filters and component breather filters promote long service intervals. Possibility to log and analyze data to facilitate troubleshooting.

Fuel tank	335 l (88.5 US gal)
Engine coolant	45 l (11.9 US gal)
Hydraulic oil tank	156 l (41.2 US gal)
Transmission oil	45 l (11.9 US gal)
Engine oil	42 l (11.1 US gal)
Axle oil front/rear	45/55 l (11.9/14.5 US gal)

SPECIFICATIONS

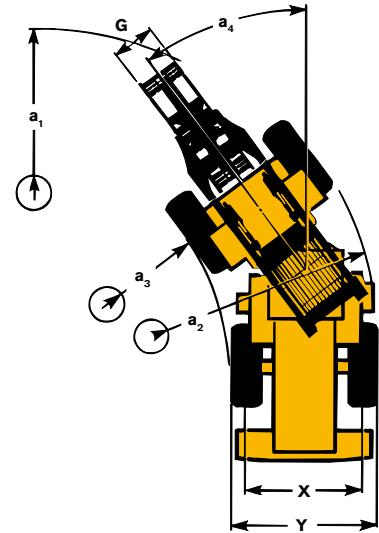
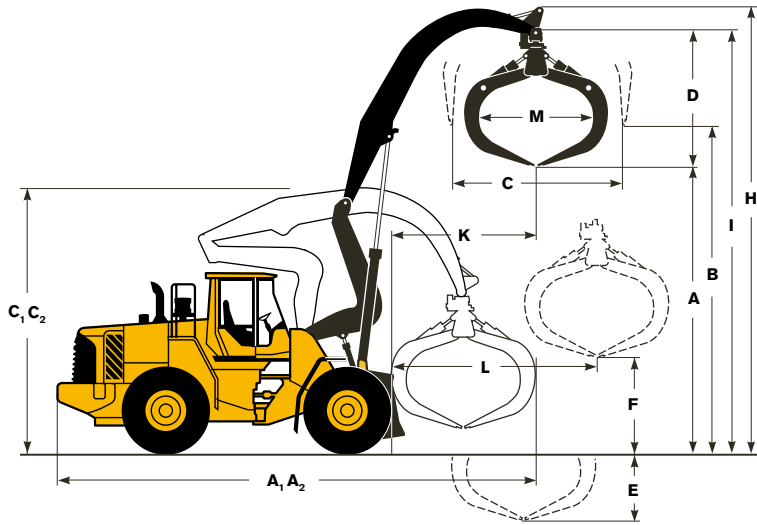

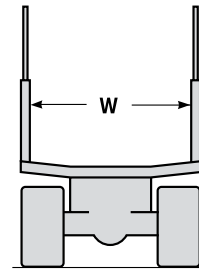

Tires: 775/65 R29*

Rotating grapple, 360°, 3.2 m ² (34.4 ft ²), 82127		
A ₁	Grapple positioned lengthwise	9580 mm (31.4 ft)
	- with log pusher	9916 mm (32.5 ft)
A ₂	Grapple tilted forward	10 570 mm (34.6 ft)
C ₁	Grapple positioned lengthwise	5160 mm (16.9 ft)
C ₂	Grapple tilted forward	4760 mm (15.6 ft)
H		9132 mm (29.9 ft)
I		8930 mm (29.2 ft)
K		2760 mm (9.0 ft)
L		3990 mm (13.0 ft)
X		2280 mm (7.4 ft)
Y		3080 mm (10.1 ft)
a ₁		7630 mm (25.0 ft)
a ₂		6840 mm (22.4 ft)
a ₃		3830 mm (12.5 ft)
a ₄		±37°



Note: When loading a vehicle, the log grapple's width (M-measure) should be 150 mm (0.4 ft) narrower compared to the distance between the "stakes" (W) on the vehicle.

L180F HIGH-LIFT

		TIMBER LENGTH 5.0 m (16'4")		TIMBER LENGTH 4.0 m (13'1")		PULP WOOD LENGTH 4.0 m (13'1")	
Tires 775/65 R29*							
Grapple area	m ² ft ²	3.2 (34.4)	3.2 (34.4)	3.5 (37.7)	3.8 (40.9)	3.8 (40.9)	
Grapple weight	kg lb	1880 (4,144)	2050/1960 (4,519/4,321)	2150 (4,739)	2020/1940 (4,453/4,276)	2210 (4,872)	
Working load	kg lb	8800 (19,400)	8600/8700 (18,959/19,180)	8500 (18,379)	8600/8700 (18,959/19,180)	8500 (18,379)	
A	mm ft	5800 (19'0")	5800 (19'0")	5700 (18'0")	5350 (17'0")	5350 (17'0")	
B	mm ft	6700 (21'0")	6700 (21'0")	6600 (21'0")	6450 (21'0")	6450 (21'0")	
C	mm ft	3630 (11'0")	3630 (11'0")	3750 (12'0")	4500 (14'0")	4500 (14'0")	
D	mm ft	2900 (9'0")	2900 (9'0")	2850 (9'0")	3350 (10'0")	3200 (10'0")	
E	mm ft	1330 (4'0")	1330 (4'0")	1430 (4'0")	1780 (5'0")	1780 (5'0")	
F	mm ft	2255 (7'0")	2255 (7'0")	2150 (7'0")	1800 (5'0")	1800 (5'0")	
G	mm ft	1100 (3'0")	1100/900 (3'0")/2'0")	1100 (3'0")	1100/900 (3'0")/2'0")	900 (2'0")	
M	mm ft	2400 (7'0")	2400 (7'0")	2550 (8'0")	2350 (7'0")	2350 (7'0")	
Operating weight*	kg lb	33 400 (73,634)	33 570/33 480 (74,009/73,810)	33 480 (73,810)	33 540/33 460 (73,7943/73,766)	33 810 (74,538)	
Shortwood (pulpwood)					x	x	
Timber		x	x	x			
Terminal handling		x	x	x	x	x	
Unloading/loading of vehicles		x	x	x	x/x	x/x	
Unloading against wall					x	x	
With hydraulic clamping arms			x	x		x	
With triplex chain		x			x		
Order no.		91852	82127/82126	82128	94463/93607	82129	

* Including liquid in rear tires. Optional liquid in front tires increases weight by 1830 kg **(4,034 lb)**.
The log pusher increases operating weight by 800 kg **(1,764 lb)**. Log pusher, order no. 84184.

STANDARD EQUIPMENT

Service and maintenance

Engine oil remote drain and fill
Transmission oil remote drain and fill
Pressure check connections: transmission and hydraulic, quick-couplings
Toolbox, lockable
Automatic lubrication system

Engine

Three-stage air cleaner, pre-cleaner, primary and secondary filter
Indicator glass for coolant level
Preheating of induction air
Fuel pre-filter with water trap
Fuel filter
Crankcase breather oil trap
Exhaust heat insulation
Reversible cooling fan

Electrical system

24 V, pre-wired for optional accessories
Alternator 24V/ 80A
Battery disconnect switch with removable key
Fuel gauge
Hour meter
Electric horn
Combination instrument:
• Fuel level
• Transmission temperature
• Coolant temperature
• Instrument lighting
Lighting:
• Twin halogen front headlights with high and low beams
• Parking lights
• Double brake and tail lights
• Turn signals with flashing hazard light function
• Halogen work lights (2 front and 2 rear)

Conronic monitoring system

Monitoring and logging of machine data
Conronic display
Fuel consumption
Ambient temperature
Clock
Test function for warning and indicator lights
Brake test
Test function, sound level at max. fan speed
Warning and indicator lights:
• Battery charging
• Parking brake
Warning and display message:
• Engine coolant temperature
• Charge-air temperature
• Engine oil temperature
• Engine oil pressure
• Transmission oil temperature
• Transmission oil pressure
• Hydraulic oil temperature
• Brake pressure
• Parking brake applied
• Brake charging
• Overspeed at direction change
• Axle oil temperature
• Steering pressure
• Crankcase pressure
• Attachment lock open
Level warnings:
• Fuel level
• Engine oil level
• Engine coolant level
• Transmission oil level
• Hydraulic oil level
• Washer fluid level
Engine torque reduction in case of malfunction indication:
• High engine coolant temperature
• High engine oil temperature
• Low engine oil pressure
• High crankcase pressure
• High charge-air temperature
Engine shutdown to idle in case of malfunction indication:
• High transmission oil temperature
• Slip in transmission clutches
Keypad, background lit
Start interlock when gear is engaged

Drivetrain

Automatic Power Shift
Fully automatic gearshifting, 1-4
PWM-controlled gearshifting
Indicator glass for transmission oil level
Differentials: Front, 100% hydraulic diff lock. Rear, conventional.

Brake system

Axle oil cooler and filter for front and rear axle
--

Tires

775/65 R29"
Liquid in rear tires

Cab

ROPS (ISO 3471), FOPS (ISO 3449)
Single key kit door/start
Acoustic inner lining
Ashtyay
Cigarette lighter, 24 V power outlet
Lockable door
Cab heating with fresh air inlet and defroster
Fresh air inlet with two filters
Automatic heat control
Floor mat
Dual interior lights
Dual interior rearview mirrors
Dual exterior rearview mirrors
Sliding window, right side
Tinted safety glass
Retractable seatbelt (SAE J386)
Seatbelt 3", (width 75 mm (0.246 ft))
Adjustable steering wheel
Storage compartment
Document pocket
Sun visor
Beverage holder
Windshield washer front and rear
Windshield wipers front and rear
Interval function for front and rear wipers
Operator's seat, KAB, air-susp., heavy-duty for CDC and/or "elservo"
Window, sliding, door
Universal door/ignition key

Hydraulic system

Main valve, 2-spool
Main valve, 4-spool
Variable displacement axial piston pumps (3) for:
• Working hydraulics
• Steering system, pilot hydraulics, and brakes
• Fan motor
Tilt arm positioner, automatic with position indicator, adjustable
Hydraulic oil cooler
Boom Suspension System
Rotator

External equipment

Fenders, front and rear
Viscous cab mounts
Rubber mounts for engine and transmission
Easy-to-open side panels
Frame, joint lock
Vandalism lock prepared for
• Batteries
• Engine compartment
• Radiator grill
Lifting eyes
Tie-down eyes
Tow hitch
Protection, lift cylinders
Footsteps, front frame
Counterweight, logging

OPTIONAL EQUIPMENT (Standard on certain markets)**Service and maintenance**

Oil sampling valve
Refill pump for grease to lube system
Tool kit
Wheel nut wrench kit

Engine

Air pre-cleaner, cyclone type
Air pre-cleaner, cyclone type, two-stage
Air pre-cleaner, oil-bath type
Air pre-cleaner, turbo type
Engine auto shutdown
Engine block heater, 120 V USA
ESW, Disabled engine protection
ESW, Increased engine protection
Fuel fill strainer
Fuel heater
Hand throttle control
Max. fan speed, hot climate

Electrical system

Alternator, 80 A with air filter
Anti-theft device
Battery disconnect switch, additional in cab, US only
Fire suppression system
Headlights, front, guards
Rearview mirrors, adjustable, el. heated
Rearview camera incl. monitor, color
Reverse alarm
Shortened headlight support brackets
Rotating beacon
Working lights, attachments
Working lights front, extra
Working lights rear, on cab
Working lights rear, on cab, dual

Cab

Automatic Climate Control, ACC
ACC control panel, with Fahrenheit scale
Armrest, operator's seat, KAB, left only
Asbestos dust protection filter
Carbon filter
Lunch box holder
Radio installation kit incl. 11 amp 12 volt outlet, left-side
Radio installation kit incl. 11 amp 12 volt outlet, right-side
Radio installation kit incl. 20 amp 12 V outlet, US only
Radio with CD-player
Steering wheel knob
Sun blinds, rear windows
Sun blinds, side windows
Timer cab heating

Drivetrain

Speed limiter, 20 km/h (12.4 MPH)
Speed limiter, 30 km/h (18.6 MPH)

Brake system

Stainless steel, brake lines

Hydraulic system

Hydraulic fluid, biodegradable, Panolin
Hydraulic fluid, fire-resistant

External equipment

Cab ladder, rubber-suspended
Fender widener, front/rear for 80-series tires
Fenders, fixed front and swing-out rear, fender wideners incl. protection bar front

Protective equipment

Belly guard rear
Belly guard rear, oil pan
Guards for front headlights
Guards for radiator grill
Guards for tail lights, heavy-duty
Windows, side and rear guards
Steer cylinder guards
Special hydraulic fixture for shipment protection

Other equipment

Comfort Drive Control (CDC)
Secondary steering with automatic test function
Sign, slow moving vehicle

Attachments

Log pusher

Tires

Liquid for front tires



Volvo Construction Equipment is different. The company's products are designed, built and supported in a different way. That difference comes from our 175-year engineering heritage. A heritage of thinking first about the people who actually use the machines. About how to make them safer, more comfortable, more productive. About the environment we all share. The result of that thinking is a growing range of machines and a global support network dedicated to helping you do more. People around the world are proud to use Volvo. And we're proud of what makes Volvo different - **More care. Built in.**



Not all products are available in all markets. Under our policy of continuous improvement, we reserve the right to change specifications and design without prior notice. The illustrations do not necessarily show the standard version of the machine.

VOLVO

Volvo Construction Equipment
www.volvoce.com/na

Ref. No. 22 A 100 2741
Printed in USA 05/08 - 3,0
Volvo, Asheville
Copyright © 2008 Volvo

English
USA